

AIR CONDITIONER

Wall mounted type

DESIGN & TECHNICAL MANUAL

For Extra Cold Climate Area

INDOOR



ASU18RLF
ASU24RLF

OUTDOOR

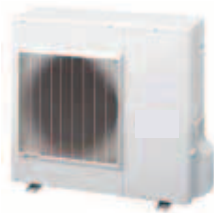

AOU18RLXFWH
AOU24RLXFWH

FUJITSU GENERAL LIMITED

Notices:

- Product specifications and design are subject to change without notice for future improvement.
- For further details, please check with our authorized dealer.

CONTENTS

Part 1. INDOOR UNIT..... 1

1. Specifications	2
2. Dimensions	3
2-1. Models: ASU18RLF and ASU24RLF	3
3. Wiring diagrams	5
3-1. Models: ASU18RLF and ASU24RLF	5
4. Capacity table	6
4-1. Cooling capacity.....	6
4-2. Heating capacity	8
5. Fan performance	9
5-1. Air velocity distributions.....	9
5-2. Airflow	12
6. Operation noise (sound pressure)	14
6-1. Noise level curve.....	14
6-2. Sound level check point	15
7. Safety devices	16
8. External input and output	17
8-1. External input.....	17
8-2. External output.....	19
9. Remote controller	20
9-1. Wireless remote controller	20
10. Function settings	22
10-1. Function settings by using remote controller.....	22
11. Accessories	29
12. Optional parts	30
12-1. Controllers	30
12-2. Others	30

CONTENTS (continued)

Part 2. OUTDOOR UNIT	31
1. Specifications	32
2. Dimensions	33
2-1. Models: AOU18RLXFWH and AOU24RLXFWH.....	33
3. Installation space	34
3-1. Models: AOU18RLXFWH and AOU24RLXFWH.....	34
4. Refrigerant circuit	37
4-1. Models: AOU18RLXFWH and AOU24RLXFWH.....	37
5. Wiring diagrams	38
5-1. Model: AOU18RLXFWH.....	38
5-2. Model: AOU24RLXFWH.....	39
6. Capacity compensation rate for pipe length and height difference	40
6-1. Models: AOU18RLXFWH and AOU24RLXFWH.....	40
7. Additional charge calculation	41
7-1. Models: AOU18RLXFWH and AOU24RLXFWH.....	41
8. Airflow	42
8-1. Model: AOU18RLXFWH.....	42
8-2. Model: AOU24RLXFWH.....	42
9. Operation noise (sound pressure)	43
9-1. Noise level curve.....	43
9-2. Sound level check point.....	44
10. Electrical characteristics	45
11. Safety devices	46
12. Accessories	47

Part 1. INDOOR UNIT

WALL MOUNTED TYPE:

ASU18RLF

ASU24RLF

1. Specifications

Type				Wall mounted					
				Inverter heat pump					
Model name				ASU18RLF	ASU24RLF				
Power supply				208/230 V ~ 60 Hz					
Available voltage range				187—253 V					
Capacity	Cooling	Rated	kW	5.28	6.44				
		Min.—Max.	Btu/h	18,000	22,000				
			kW	2.05—6.74	2.90—8.00				
	Heating	Min.—Max.	Btu/h	7,000—23,000	9,900—27,300				
			kW	6.30	7.38				
		Rated	Btu/h	21,600	25,200				
Input power	Cooling	Min.—Max.	kW	1.35	1.76				
				0.50—3.01	0.58—3.42				
				Heating	Rated	1.75	1.94		
	Heating	Min.—Max.	kW	0.48—3.23	0.50—3.53				
				Rated	A	6.2	7.9		
				Heating	Rated	7.8	8.6		
EER	Cooling		kW/kW	3.90	3.66				
			Btu/hW	13.3	12.5				
COP	Heating		kW/kW	3.62	3.80				
			Btu/hW	12.3	13.0				
SEER	Cooling		Btu/hW	20.0	19.5				
HSPF	Heating		Btu/hW	10.4	10.5				
Power factor	Cooling		%	95.0	97.0				
	Heating		%	97.6	98.1				
Moisture removal			pints/h (L/h)	5.9 (2.8)	6.3 (3.0)				
Maximum operating current *1				Cooling	A	13.5	15.0		
				Heating	A	14.5	15.5		
Fan	Airflow rate	Cooling	HIGH	CFM (m ³ /h)	541 (920)	659 (1,120)			
			MED		435 (740)	530 (900)			
			LOW		365 (620)	435 (740)			
		Heating	QUIET		306 (520)	365 (620)			
			HIGH		541 (920)	677 (1,150)			
			MED		435 (740)	530 (900)			
	Type × Q'ty	Motor output		W	Cross flow fan × 1				
					53				
					Cooling	dB (A)	HIGH	43	49
							MED	37	42
LOW	33	37							
Heating	dB (A)	QUIET	28	33					
		HIGH	44	49					
		MED	37	42					
Heat exchanger type	Dimensions (H × W × D)		in (mm)	Main: 14-7/8 × 32-3/4 × 1-1/16 (378 × 832 × 26.6) Sub: 3-5/16 × 32-3/4 × 1/2 (84 × 832 × 13.3)					
	Fin pitch		FPI	Main: 21, Sub: 18					
	Rows × Stages			Main: 2 × 18, Sub: 1 × 4					
	Pipe type			Copper tube					
	Fin type			Aluminum					
	Material			Polystyrene					
Enclosure		Color		White Approximate color of Munsell N 9.25/					
Dimensions (H × W × D)	Net	in		12-5/8 × 39-5/16 × 9					
		mm		320 × 998 × 228					
	Gross	in		12-9/16 × 42-15/16 × 16-7/8					
		mm		319 × 1,090 × 429					
Weight	Net		lb (kg)		31 (14)				
	Gross		lb (kg)		40 (18)				
Connection pipe	Size	Liquid	in (mm)	Ø 3/8 (Ø 9.52)					
		Gas		Ø 5/8 (Ø 15.88)					
	Method				Flare				
Drain hose	Material				PVC				
	Size		in (mm)		Ø 15/32 (Ø 12) (I.D.), Ø 5/8 (Ø 16) (O.D.)				
Operation range	Cooling	°F (°C)		64 to 90 (18 to 32)					
		%RH		80 or less					
	Heating	°F (°C)		88 (30) or less					
Remote controller type				Wireless (Wired [option])					

NOTES:

- Specifications are based on the following conditions:
 - Cooling: Indoor temperature of 80 °FDB (26.67 °CDB) /67 °FWB (19.44 °CWB), and outdoor temperature of 95 °FDB (35 °CDB) / 75 °FWB (23.9 °CWB).
 - Heating: Indoor temperature of 70 °FDB (21.11 °CDB) /59 °FWB (15 °CWB), and outdoor temperature of 47 °FDB (8.33 °CDB) /43 °FWB (6.11 °CWB).
 - Pipe length: 24 ft 6 in (7.5 m), Height difference: 0 ft (0 m). (Between outdoor unit and indoor unit.)
- Protective function might work when using it outside the operation range.
- *1: Maximum current is maximum value when operated within the operation range.
- *2: Sound pressure level:
 - Measured values in manufacturer's anechoic chamber.
 - Because of the surrounding sound environment, the sound levels measured in actual installation conditions might be higher than the specified values here.

2. Dimensions

2-1. Models: ASU18RLF and ASU24RLF

Unit: in (mm)

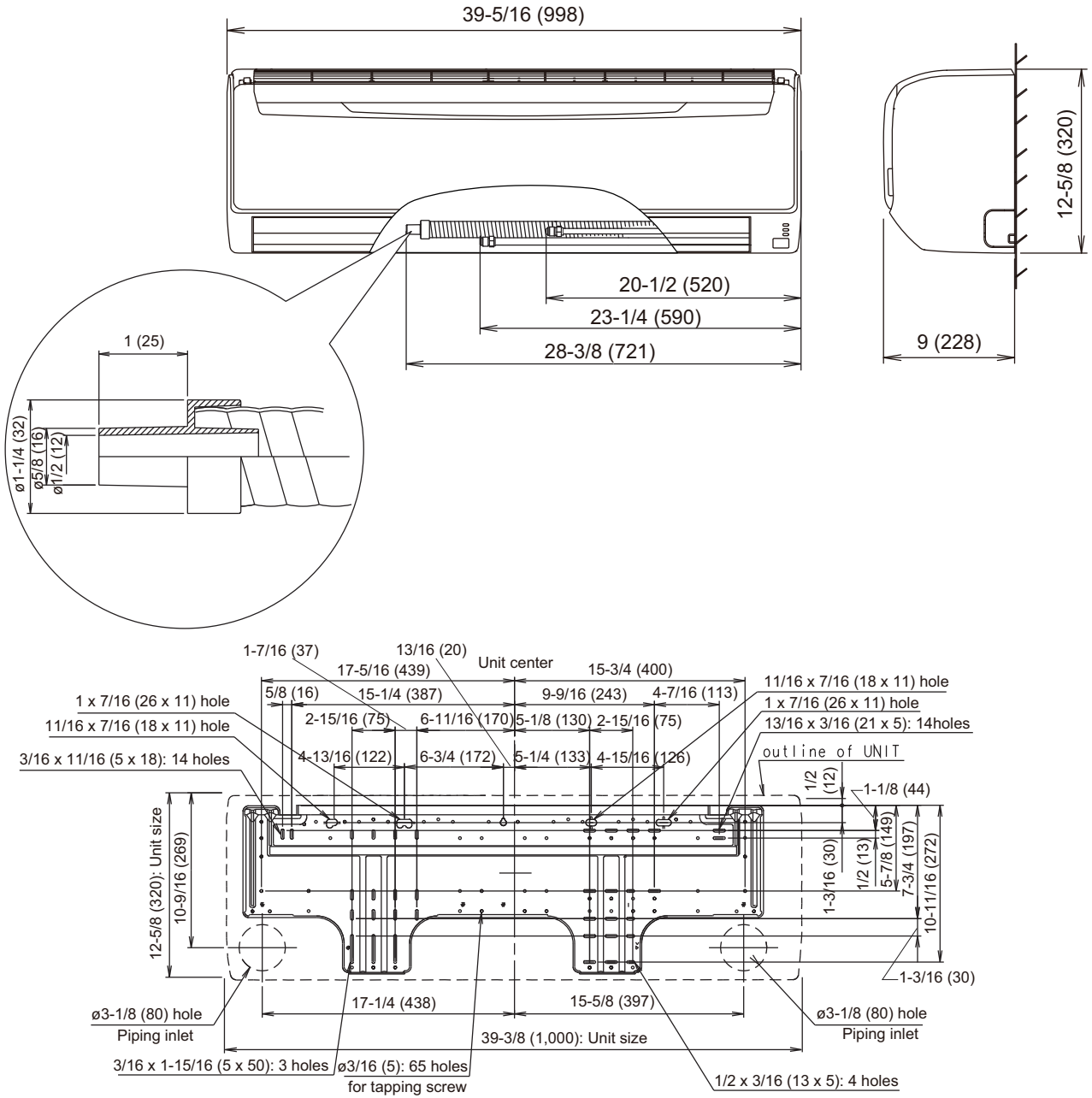

■ Installation space requirement

Provide sufficient installation space for product safety.

Unit: in (mm)

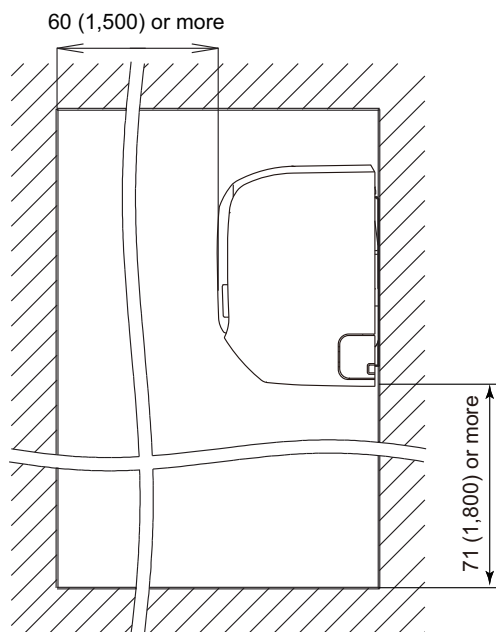
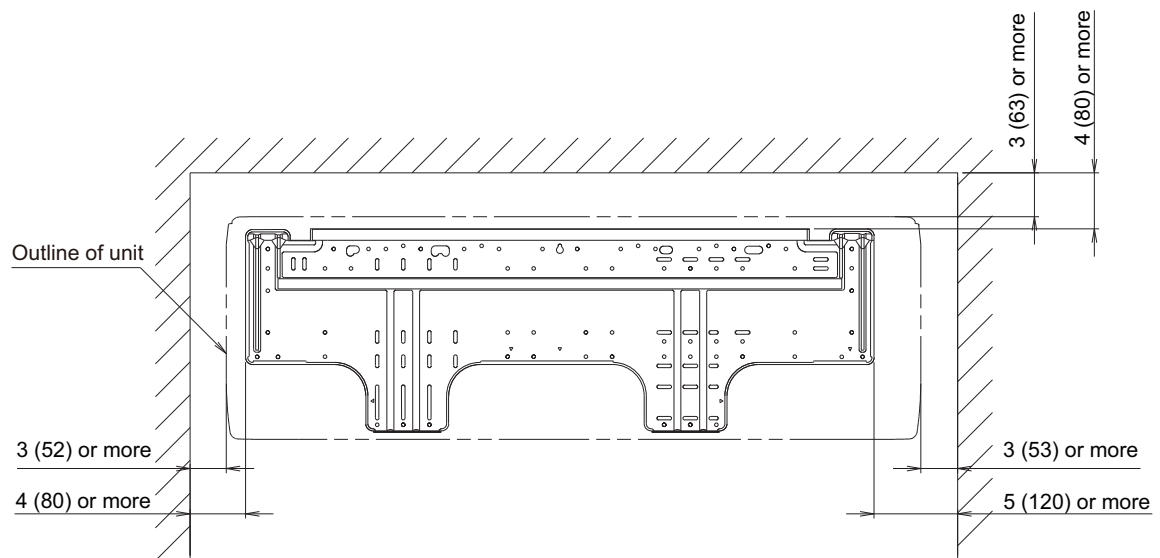

3. Wiring diagrams

3-1. Models: ASU18RLF and ASU24RLF

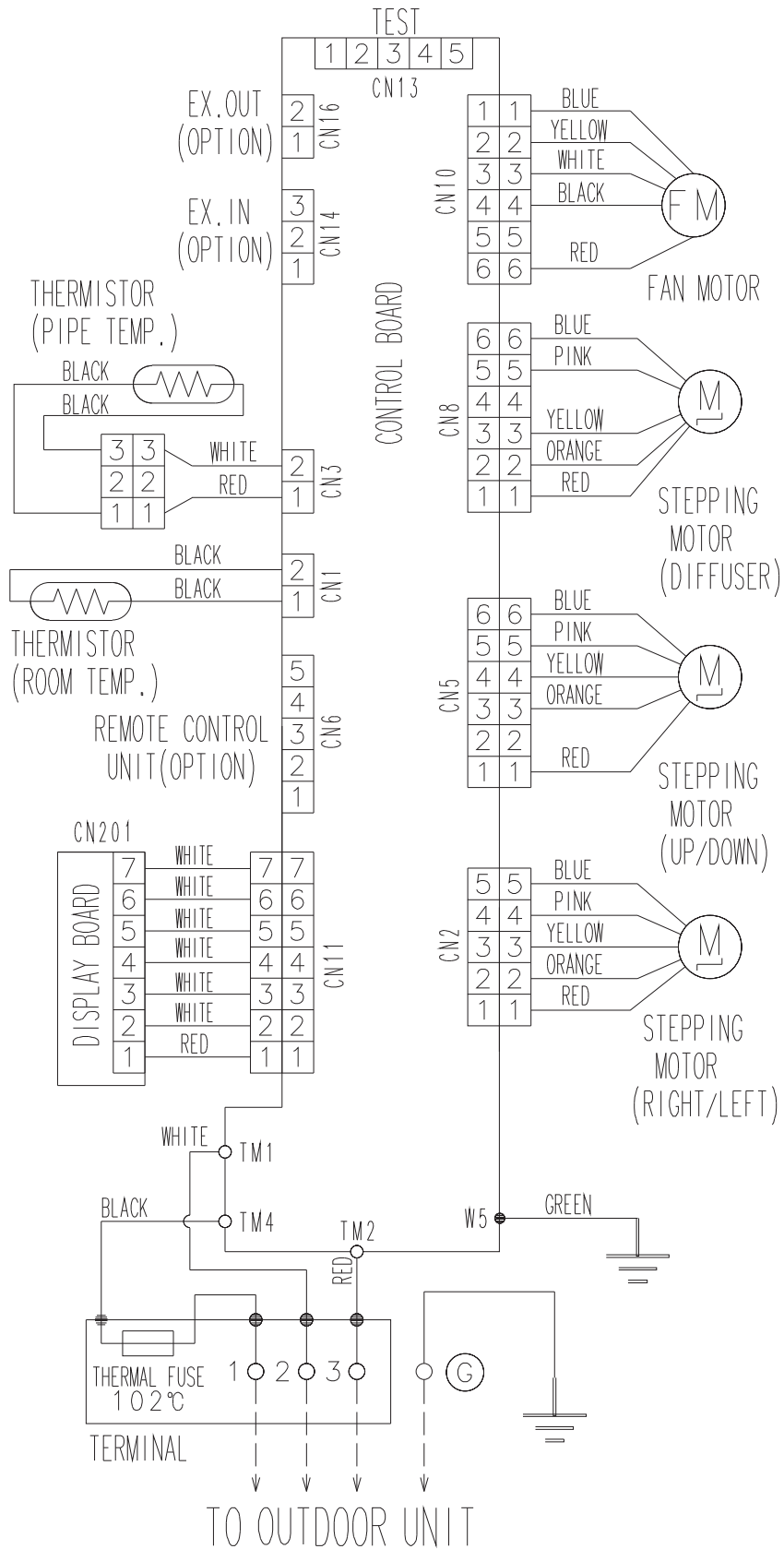

4. Capacity table

Capacity tables show each of following values calculated based on the outdoor temperature and the indoor temperature, under given Airflow Rate (AFR):

For cooling capacity: Total Capacity (TC), Sensible Heat Capacity (SHC), and Input Power (IP)

For heating capacity: Total Capacity (TC) and Input Power (IP)

4-1. Cooling capacity

■ Model: ASU18RLF

AFR	CFM	541
-----	-----	-----

		Indoor temperature																	
		64			70			75			80			85			90		
		54			60			63			67			71			73		
Outdoor temperature	°FDB	TC	SHC	IP	TC	SHC	IP	TC	SHC	IP	TC	SHC	IP	TC	SHC	IP	TC	SHC	IP
	°FDB	kBtu	kW	kBtu	kW	kBtu	kW	kBtu	kW	kBtu	kW	kBtu	kW	kBtu	kW	kBtu	kW	kBtu	kW
-5	17.81	11.45	0.29	19.85	11.51	0.29	21.88	12.56	0.29	22.55	13.56	0.30	23.89	13.52	0.30	25.27	14.39	0.30	
5	17.80	11.47	0.36	19.83	11.54	0.36	21.86	12.58	0.36	22.53	13.59	0.37	23.87	13.54	0.37	25.24	14.42	0.37	
14	17.77	11.20	0.42	19.79	11.27	0.43	21.84	12.29	0.43	22.49	13.28	0.44	23.85	13.23	0.44	25.19	14.09	0.44	
23	17.77	11.43	0.49	19.77	11.50	0.50	21.82	12.54	0.50	22.49	13.55	0.51	23.85	13.48	0.51	25.17	14.36	0.52	
32	17.74	11.64	0.56	19.77	11.71	0.57	21.82	12.77	0.57	22.47	13.80	0.58	23.82	13.75	0.58	25.14	14.65	0.59	
41	17.74	11.18	0.62	19.75	11.27	0.63	21.80	12.27	0.64	22.47	13.26	0.65	23.82	13.21	0.65	25.14	14.07	0.66	
50	17.70	11.41	0.71	19.70	11.50	0.72	21.75	12.54	0.73	22.40	13.55	0.73	23.75	13.48	0.74	25.07	14.36	0.74	
59	17.37	11.16	0.78	19.35	11.23	0.79	21.33	12.25	0.80	21.97	13.24	0.81	23.30	13.17	0.81	24.60	14.02	0.82	
67	16.65	10.85	0.92	18.56	10.92	0.93	20.47	11.91	0.95	21.09	12.86	0.95	22.35	12.83	0.96	23.61	13.65	0.97	
77	15.90	10.54	1.06	17.74	10.61	1.07	19.55	11.57	1.09	20.13	12.49	1.09	21.36	12.45	1.11	22.55	13.27	1.12	
87	15.12	10.20	1.19	16.82	10.27	1.21	18.56	11.19	1.23	19.14	12.11	1.23	20.27	12.04	1.25	21.43	12.83	1.26	
95	14.23	9.86	1.30	15.87	9.93	1.32	17.47	10.82	1.34	18.02	11.67	1.35	19.11	11.63	1.36	20.16	12.39	1.38	
104	13.58	9.59	1.45	15.12	9.66	1.47	16.65	10.54	1.49	17.16	11.36	1.50	18.22	11.33	1.51	19.24	12.08	1.53	
115	12.39	9.14	1.62	13.78	9.18	1.65	15.22	10.03	1.67	15.66	10.82	1.68	16.62	10.78	1.70	17.57	11.50	1.72	

AFR	m ³ /h	920
-----	-------------------	-----

		Indoor temperature																	
		17.8			21.1			23.9			26.7			29.4			32.2		
		12.2			15.6			17.2			19.4			21.7			22.8		
Outdoor temperature	°CDB	TC	SHC	IP	TC	SHC	IP	TC	SHC	IP	TC	SHC	IP	TC	SHC	IP	TC	SHC	IP
	°CDB	kW	kW	kW	kW	kW	kW	kW	kW	kW	kW	kW	kW	kW	kW	kW	kW	kW	kW
-20.6	5.22	3.36	0.29	5.82	3.37	0.29	6.41	3.68	0.29	6.61	3.97	0.30	7.00	3.96	0.30	7.41	4.22	0.30	
-15.0	5.22	3.36	0.36	5.81	3.38	0.36	6.41	3.69	0.36	6.60	3.98	0.37	7.00	3.97	0.37	7.40	4.23	0.37	
-10.0	5.21	3.28	0.42	5.80	3.30	0.43	6.40	3.60	0.43	6.59	3.89	0.44	6.99	3.88	0.44	7.38	4.13	0.44	
-5.0	5.21	3.35	0.49	5.79	3.37	0.50	6.40	3.68	0.50	6.59	3.97	0.51	6.99	3.95	0.51	7.38	4.21	0.52	
0.0	5.20	3.41	0.56	5.79	3.43	0.57	6.40	3.74	0.57	6.59	4.05	0.58	6.98	4.03	0.58	7.37	4.29	0.59	
5.0	5.20	3.28	0.62	5.79	3.30	0.63	6.39	3.60	0.64	6.59	3.89	0.65	6.98	3.87	0.65	7.37	4.12	0.66	
10.0	5.19	3.34	0.71	5.77	3.37	0.72	6.37	3.68	0.73	6.56	3.97	0.73	6.96	3.95	0.74	7.35	4.21	0.74	
15.0	5.09	3.27	0.78	5.67	3.29	0.79	6.25	3.59	0.80	6.44	3.88	0.81	6.83	3.86	0.81	7.21	4.11	0.82	
19.4	4.88	3.18	0.92	5.44	3.20	0.93	6.00	3.49	0.95	6.18	3.77	0.95	6.55	3.76	0.96	6.92	4.00	0.97	
25.0	4.66	3.09	1.06	5.20	3.11	1.07	5.73	3.39	1.09	5.90	3.66	1.09	6.26	3.65	1.11	6.61	3.89	1.12	
30.6	4.43	2.99	1.19	4.93	3.01	1.21	5.44	3.28	1.23	5.61	3.55	1.23	5.94	3.53	1.25	6.28	3.76	1.26	
35.0	4.17	2.89	1.30	4.65	2.91	1.32	5.12	3.17	1.34	5.28	3.42	1.35	5.60	3.41	1.36	5.91	3.63	1.38	
40.0	3.98	2.81	1.45	4.43	2.83	1.47	4.88	3.09	1.49	5.03	3.33	1.50	5.34	3.32	1.51	5.64	3.54	1.53	
46.1	3.63	2.68	1.62	4.04	2.69	1.65	4.46	2.94	1.67	4.59	3.17	1.68	4.87	3.16	1.70	5.15	3.37	1.72	

Model: ASU24RLF

AFR	CFM	659
-----	-----	-----

		Indoor temperature																	
		64			70			75			80			85			90		
		54			60			63			67			71			73		
Outdoor temperature	°FDB	TC	SHC	IP	TC	SHC	IP	TC	SHC	IP	TC	SHC	IP	TC	SHC	IP	TC	SHC	IP
	°FWB	kBTu			kW			kBTu			kW			kBTu			kW		
-5	19.12	11.45	0.30	21.30	11.51	0.30	23.48	12.56	0.31	24.19	13.56	0.31	25.64	13.52	0.32	27.11	14.39	0.32	
5	19.10	11.47	0.37	21.28	11.54	0.38	23.46	12.58	0.38	24.17	13.59	0.39	25.62	13.54	0.39	27.09	14.42	0.39	
14	19.06	11.37	0.45	21.23	11.44	0.45	23.42	12.46	0.46	24.13	13.45	0.46	25.56	13.40	0.47	27.04	14.29	0.47	
23	19.06	11.60	0.52	21.20	11.67	0.52	23.39	12.72	0.53	24.13	13.73	0.54	25.56	13.66	0.54	27.02	14.57	0.54	
32	19.03	11.81	0.59	21.20	11.88	0.60	23.39	12.95	0.60	24.11	13.98	0.61	25.53	13.93	0.61	26.99	14.86	0.62	
41	19.03	11.35	0.65	21.18	11.44	0.66	23.37	12.44	0.67	24.11	13.43	0.68	25.53	13.38	0.68	26.99	14.27	0.69	
50	18.98	11.58	0.74	21.12	11.67	0.75	23.32	12.72	0.76	24.03	13.73	0.77	25.46	13.66	0.77	26.92	14.57	0.78	
59	18.63	11.33	0.82	20.74	11.40	0.83	22.86	12.42	0.84	23.58	13.41	0.85	24.98	13.34	0.85	26.41	14.23	0.86	
67	17.91	11.05	0.95	19.96	11.12	0.97	21.97	12.15	0.98	22.66	13.10	0.99	24.02	13.07	1.00	25.39	13.92	1.01	
77	19.31	11.57	1.37	21.50	11.63	1.39	23.71	12.69	1.41	24.43	13.72	1.42	25.90	13.65	1.43	27.36	14.54	1.44	
87	18.36	11.23	1.53	20.47	11.29	1.55	22.55	12.32	1.58	23.27	13.31	1.58	24.63	13.24	1.60	26.03	14.13	1.61	
95	17.37	10.88	1.70	19.35	10.92	1.72	21.33	11.94	1.75	21.97	12.86	1.76	23.30	12.83	1.78	24.60	13.65	1.80	
104	16.24	10.47	1.86	18.08	10.54	1.89	19.93	11.50	1.92	20.54	12.42	1.93	21.77	12.35	1.95	23.00	13.17	1.97	
115	12.35	9.21	1.56	13.75	9.28	1.58	15.18	10.13	1.61	15.63	10.92	1.61	16.58	10.88	1.63	17.50	11.60	1.65	

AFR	m³/h	1,120
-----	------	-------

		Indoor temperature																	
		17.8			21.1			23.9			26.7			29.4			32.2		
		12.2			15.6			17.2			19.4			21.7			22.8		
Outdoor temperature	°CDB	TC	SHC	IP	TC	SHC	IP	TC	SHC	IP	TC	SHC	IP	TC	SHC	IP	TC	SHC	IP
	°CWB	kW			kW			kW			kW			kW					
-20.6	5.60	3.36	0.30	6.24	3.37	0.30	6.88	3.68	0.31	7.09	3.97	0.31	7.51	3.96	0.32	7.95	4.22	0.32	
-15.0	5.60	3.36	0.37	6.24	3.38	0.38	6.88	3.69	0.38	7.08	3.98	0.39	7.51	3.97	0.39	7.94	4.23	0.39	
-10.0	5.59	3.33	0.45	6.22	3.35	0.45	6.86	3.65	0.46	7.07	3.94	0.46	7.49	3.93	0.47	7.93	4.19	0.47	
-5.0	5.59	3.40	0.52	6.21	3.42	0.52	6.86	3.73	0.53	7.07	4.02	0.54	7.49	4.00	0.54	7.92	4.27	0.54	
0.0	5.58	3.46	0.59	6.21	3.48	0.60	6.86	3.80	0.60	7.07	4.10	0.61	7.48	4.08	0.61	7.91	4.36	0.62	
5.0	5.58	3.33	0.65	6.21	3.35	0.66	6.85	3.65	0.67	7.07	3.94	0.68	7.48	3.92	0.68	7.91	4.18	0.69	
10.0	5.56	3.39	0.74	6.19	3.42	0.75	6.83	3.73	0.76	7.04	4.02	0.77	7.46	4.00	0.77	7.89	4.27	0.78	
15.0	5.46	3.32	0.82	6.08	3.34	0.83	6.70	3.64	0.84	6.91	3.93	0.85	7.32	3.91	0.85	7.74	4.17	0.86	
19.4	5.25	3.24	0.95	5.85	3.26	0.97	6.44	3.56	0.98	6.64	3.84	0.99	7.04	3.83	1.00	7.44	4.08	1.01	
25.0	5.66	3.39	1.37	6.30	3.41	1.39	6.95	3.72	1.41	7.16	4.02	1.42	7.59	4.00	1.43	8.02	4.26	1.44	
30.6	5.38	3.29	1.53	6.00	3.31	1.55	6.61	3.61	1.58	6.82	3.90	1.58	7.22	3.88	1.60	7.63	4.14	1.61	
35.0	5.09	3.19	1.70	5.67	3.20	1.72	6.25	3.50	1.75	6.44	3.77	1.76	6.83	3.76	1.78	7.21	4.00	1.80	
40.0	4.76	3.07	1.86	5.30	3.09	1.89	5.84	3.37	1.92	6.02	3.64	1.93	6.38	3.62	1.95	6.74	3.86	1.97	
46.1	3.62	2.70	1.56	4.03	2.72	1.58	4.45	2.97	1.61	4.58	3.20	1.61	4.86	3.19	1.63	5.13	3.40	1.65	

4-2. Heating capacity

■ Model: ASU18RLF

AFR	CFM	541
-----	-----	-----

Outdoor temperature		Indoor temperature											
		°FDB	°FWB	60		65		70		72		75	
				TC kBtu	IP kW	TC kBtu	IP kW	TC kBtu	IP kW	TC kBtu	IP kW	TC kBtu	IP kW
-15	-17	18.80	1.76	18.37	1.80	17.91	1.83	17.46	1.87	17.02	1.90		
-5	-7	20.67	2.28	20.20	2.33	19.70	2.37	19.19	2.42	18.72	2.46		
5	3	22.67	2.65	22.13	2.70	21.60	2.75	21.06	2.80	20.53	2.85		
14	12	23.46	2.82	22.89	2.88	22.37	2.93	21.80	2.99	21.24	3.04		
23	19	24.70	3.01	24.12	3.07	23.51	3.13	22.93	3.19	22.35	3.25		
32	28	27.47	3.02	26.82	3.08	26.17	3.14	25.52	3.20	24.87	3.26		
41	37	29.31	2.84	28.59	2.90	27.91	2.96	27.23	3.02	26.51	3.08		
47	43	30.47	2.87	29.72	2.93	29.00	2.99	28.29	3.05	27.57	3.11		
50	47	30.98	2.85	30.26	2.91	29.51	2.97	28.76	3.03	28.05	3.09		
59	50	29.24	2.48	28.56	2.53	27.84	2.58	27.16	2.63	26.44	2.68		

AFR	m ³ /h	920
-----	-------------------	-----

Outdoor temperature		Indoor temperature											
		°CDB	°CWB	15.6		18.3		21.1		22.2		23.9	
				TC kW	IP	TC kW	IP	TC kW	IP	TC kW	IP	TC kW	IP
-26.1	-27.2	5.51	1.76	5.38	1.80	5.25	1.83	5.12	1.87	4.99	1.90		
-20.6	-21.7	6.06	2.28	5.92	2.33	5.77	2.37	5.63	2.42	5.49	2.46		
-15.0	-16.1	6.64	2.65	6.49	2.70	6.33	2.75	6.17	2.80	6.02	2.85		
-10.0	-11.1	6.87	2.82	6.71	2.88	6.56	2.93	6.39	2.99	6.22	3.04		
-5.0	-7.2	7.24	3.01	7.07	3.07	6.89	3.13	6.72	3.19	6.55	3.25		
0.0	-2.2	8.05	3.02	7.86	3.08	7.67	3.14	7.48	3.20	7.29	3.26		
5.0	2.8	8.59	2.84	8.38	2.90	8.18	2.96	7.98	3.02	7.77	3.08		
8.3	6.1	8.93	2.87	8.71	2.93	8.50	2.99	8.29	3.05	8.08	3.11		
10.0	8.3	9.08	2.85	8.87	2.91	8.65	2.97	8.43	3.03	8.22	3.09		
15.0	10.0	8.57	2.48	8.37	2.53	8.16	2.58	7.96	2.63	7.75	2.68		

■ Model: ASU24RLF

AFR	CFM	677
-----	-----	-----

Outdoor temperature		Indoor temperature											
		°FDB	°FWB	60		65		70		72		75	
				TC kBtu	IP kW	TC kBtu	IP kW	TC kBtu	IP kW	TC kBtu	IP kW	TC kBtu	IP kW
-15	-17	20.71	3.09	20.24	3.16	19.73	3.22	19.23	3.28	18.75	3.34		
-5	-7	23.66	3.30	23.12	3.36	22.54	3.43	21.97	3.50	21.43	3.56		
5	3	26.47	3.45	25.86	3.52	25.21	3.59	24.57	3.66	23.96	3.73		
14	12	28.20	3.47	27.53	3.54	26.87	3.61	26.21	3.68	25.51	3.75		
23	19	30.78	3.42	30.06	3.49	29.31	3.56	28.59	3.63	27.84	3.70		
32	28	33.81	3.42	32.99	3.48	32.21	3.55	31.39	3.62	30.61	3.69		
41	37	36.88	3.29	36.00	3.36	35.14	3.43	34.26	3.49	33.37	3.56		
47	43	37.98	3.25	37.09	3.32	36.17	3.38	35.28	3.45	34.36	3.52		
50	47	38.69	3.24	37.77	3.31	36.85	3.37	35.93	3.44	35.01	3.51		
59	50	36.85	2.85	36.00	2.91	35.11	2.97	34.22	3.03	33.37	3.09		

AFR	m ³ /h	1,150
-----	-------------------	-------

Outdoor temperature		Indoor temperature											
		°CDB	°CWB	15.6		18.3		21.1		22.2		23.9	
				TC kW	IP	TC kW	IP	TC kW	IP	TC kW	IP	TC kW	IP
-26.1	-27.2	6.07	3.09	5.93	3.16	5.78	3.22	5.64	3.28	5.50	3.34		
-20.6	-21.7	6.94	3.30	6.78	3.36	6.61	3.43	6.44	3.50	6.28	3.56		
-15.0	-16.1	7.76	3.45	7.58	3.52	7.39	3.59	7.20	3.66	7.02	3.73		
-10.0	-11.1	8.26	3.47	8.07	3.54	7.88	3.61	7.68	3.68	7.48	3.75		
-5.0	-7.2	9.02	3.42	8.81	3.49	8.59	3.56	8.38	3.63	8.16	3.70		
0.0	-2.2	9.91	3.42	9.67	3.48	9.44	3.55	9.20	3.62	8.97	3.69		
5.0	2.8	10.81	3.29	10.55	3.36	10.30	3.43	10.04	3.49	9.78	3.56		
8.3	6.1	11.13	3.25	10.87	3.32	10.60	3.38	10.34	3.45	10.07	3.52		
10.0	8.3	11.34	3.24	11.07	3.31	10.80	3.37	10.53	3.44	10.26	3.51		
15.0	10.0	10.80	2.85	10.55	2.91	10.29	2.97	10.03	3.03	9.78	3.09		

5. Fan performance

5-1. Air velocity distributions

■ Model: ASU18RLF

Measuring conditions	Fan speed	Operation mode
	HIGH	FAN

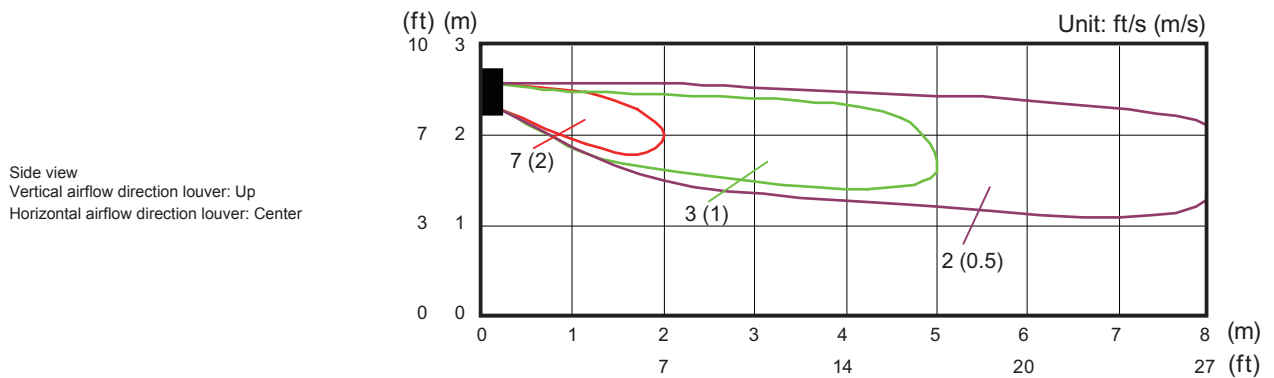
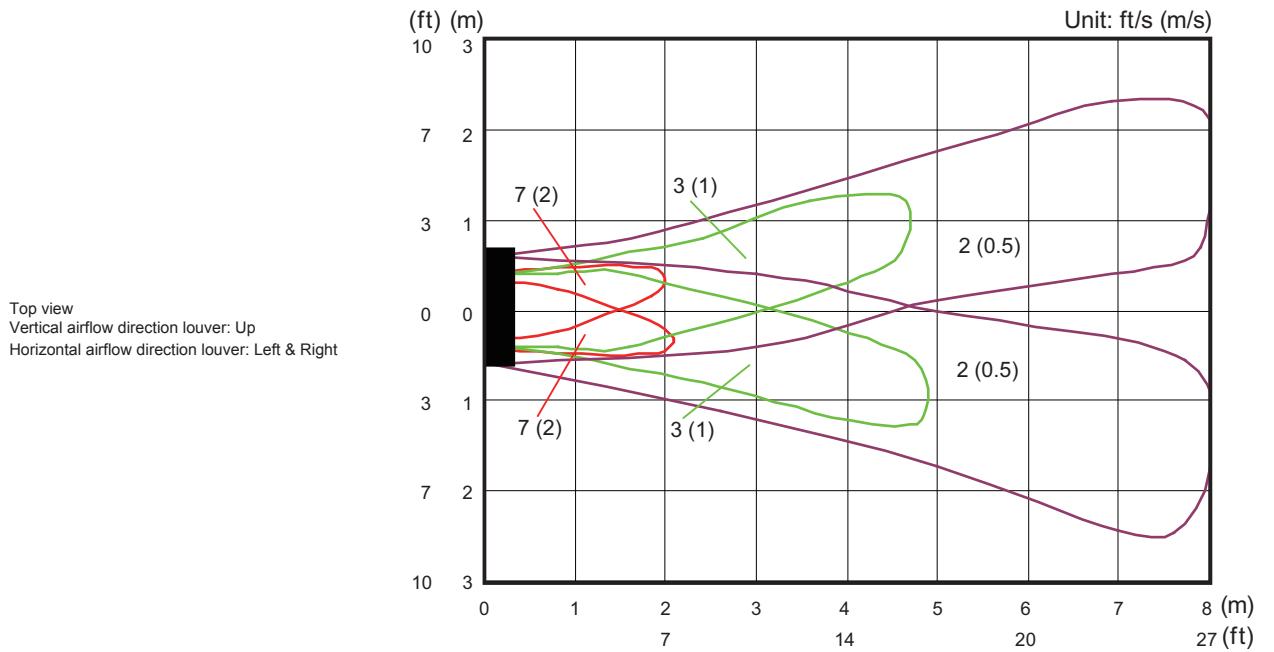
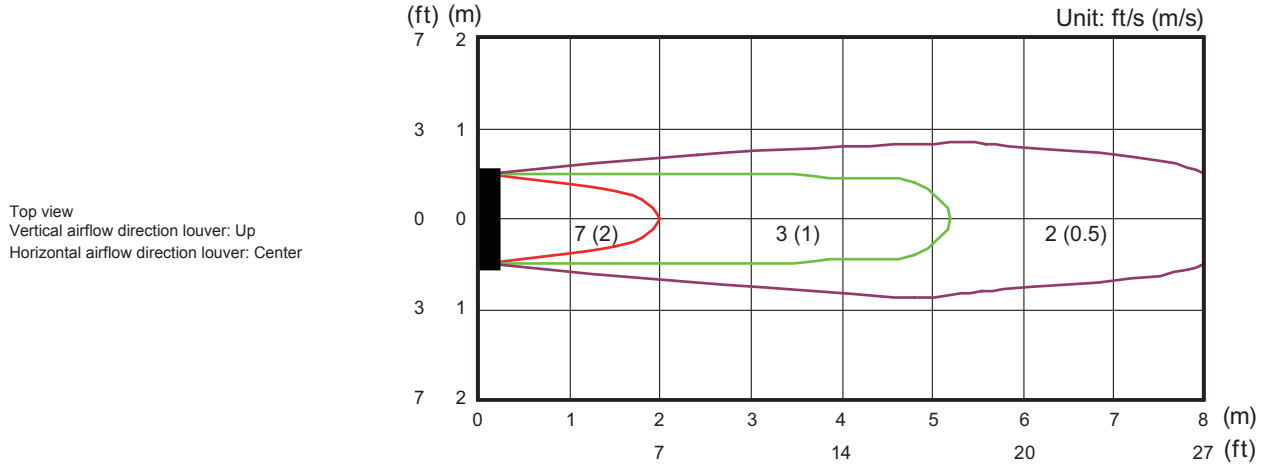

Side view
Vertical airflow direction louver: Down
Horizontal airflow direction louver: Center

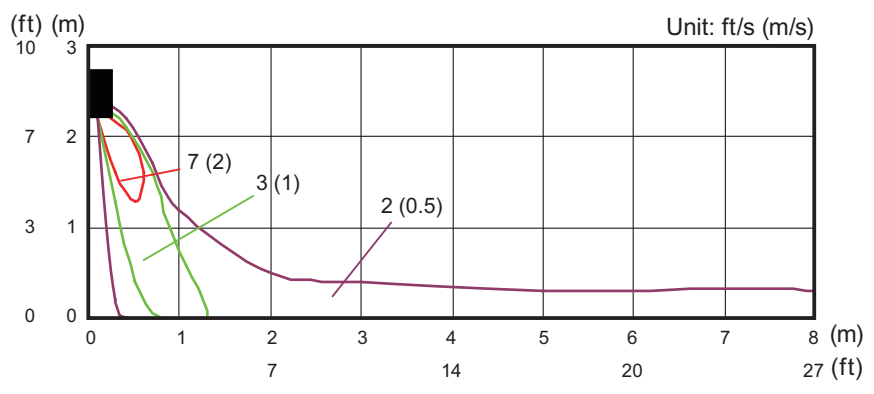

Model: ASU24RLF

Measuring conditions	Fan speed	Operation mode
	HIGH	FAN

Top view
Vertical airflow direction louver: Up
Horizontal airflow direction louver: Center

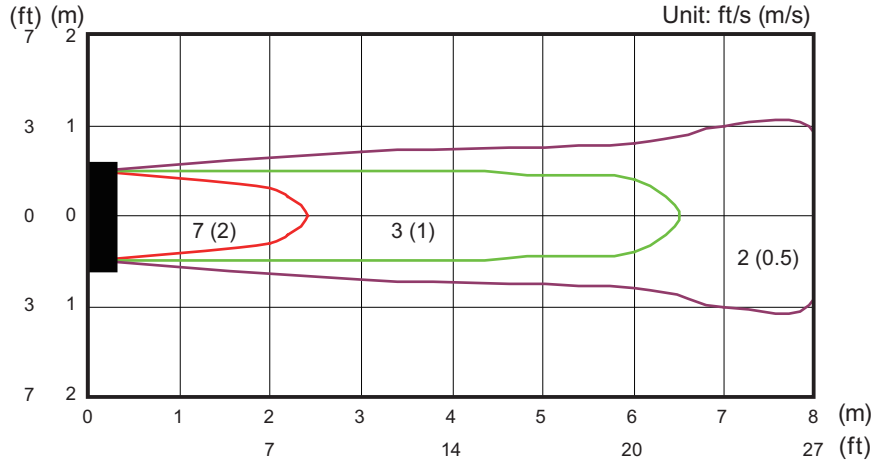

Top view
Vertical airflow direction louver: Up
Horizontal airflow direction louver: Left & Right

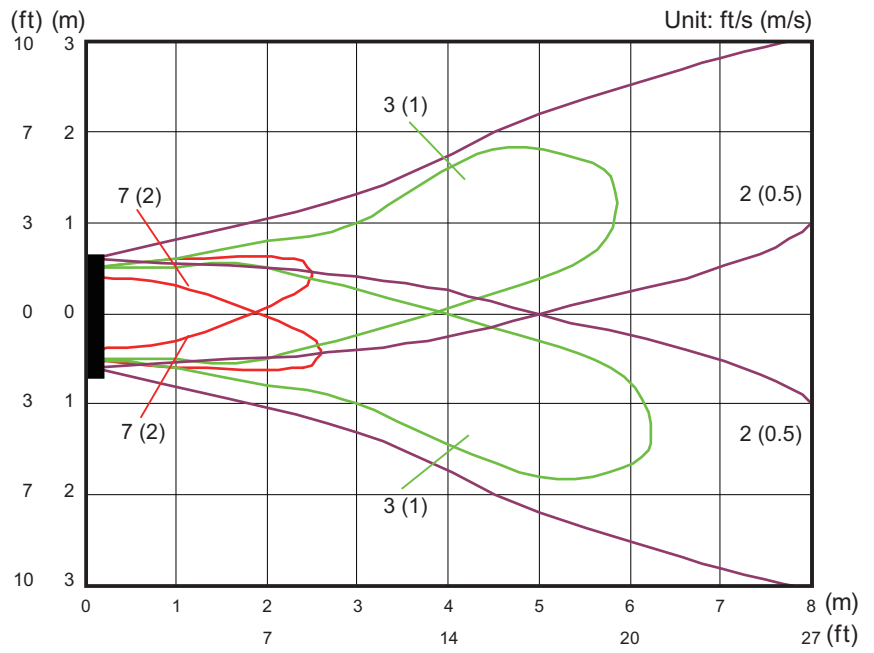

Side view
Vertical airflow direction louver: Up
Horizontal airflow direction louver: Center

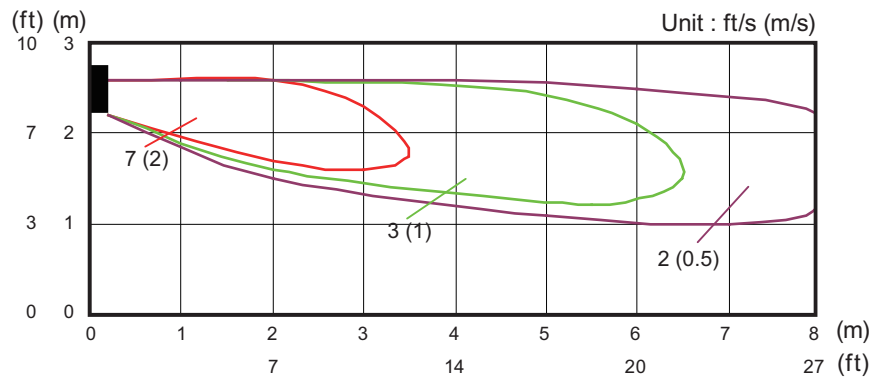

Side view
Vertical airflow direction louver: Down
Horizontal airflow direction louver: Center

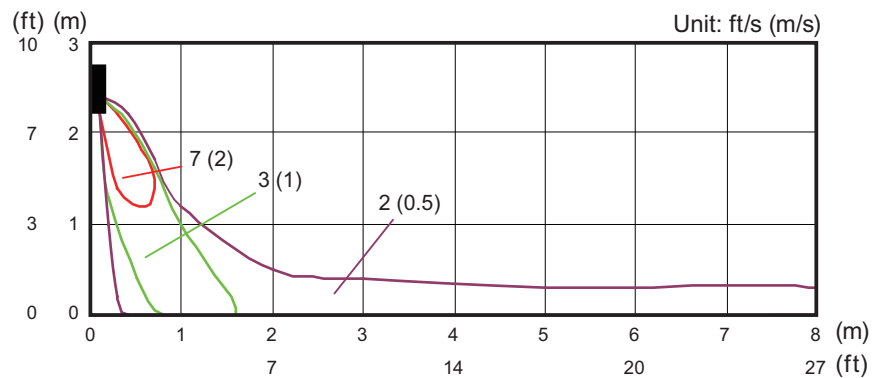

5-2. Airflow

■ Model: ASU18RLF

● Cooling

Fan speed	Airflow	
HIGH	m ³ /h	920
	l/s	256
	CFM	541
MED	m ³ /h	740
	l/s	206
	CFM	435
LOW	m ³ /h	620
	l/s	172
	CFM	365
QUIET	m ³ /h	520
	l/s	144
	CFM	306

● Heating

Fan speed	Airflow	
HIGH	m ³ /h	920
	l/s	256
	CFM	541
MED	m ³ /h	740
	l/s	206
	CFM	435
LOW	m ³ /h	620
	l/s	172
	CFM	365
QUIET	m ³ /h	540
	l/s	150
	CFM	318

■ Model: ASU24RLF

● Cooling

Fan speed	Airflow	
HIGH	m ³ /h	1,120
	l/s	311
	CFM	659
MED	m ³ /h	900
	l/s	250
	CFM	530
LOW	m ³ /h	740
	l/s	206
	CFM	435
QUIET	m ³ /h	620
	l/s	172
	CFM	365

● Heating

Fan speed	Airflow	
HIGH	m ³ /h	1,150
	l/s	319
	CFM	677
MED	m ³ /h	900
	l/s	250
	CFM	530
LOW	m ³ /h	740
	l/s	206
	CFM	435
QUIET	m ³ /h	620
	l/s	172
	CFM	365

6. Operation noise (sound pressure)

6-1. Noise level curve

Model: ASU18RLF

● Cooling

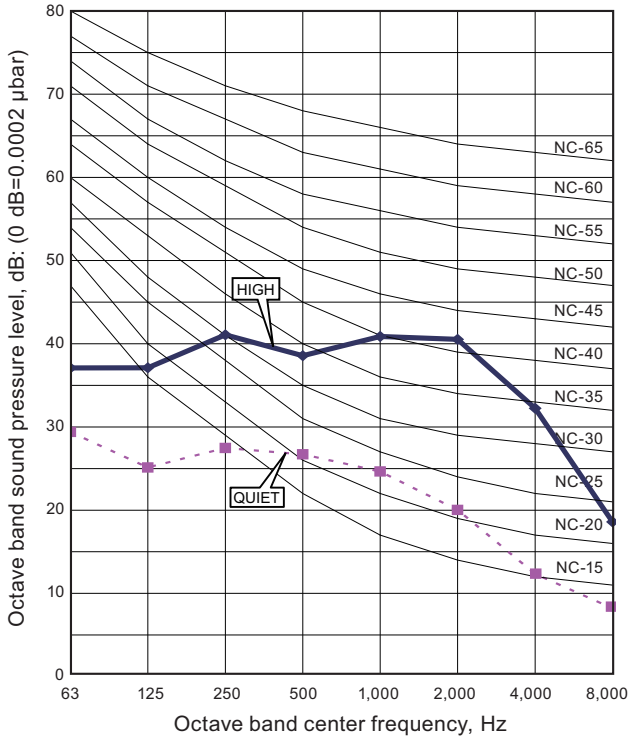

● Heating

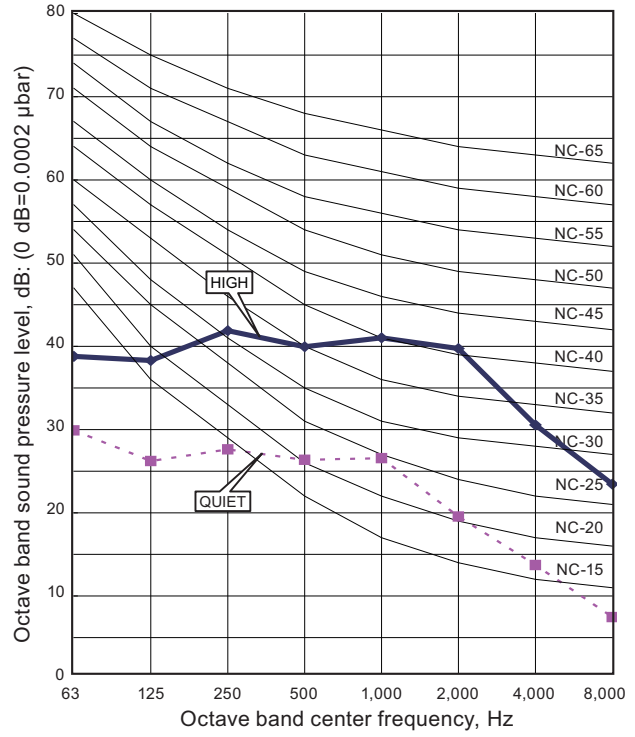

Model: ASU24RLF

● Cooling

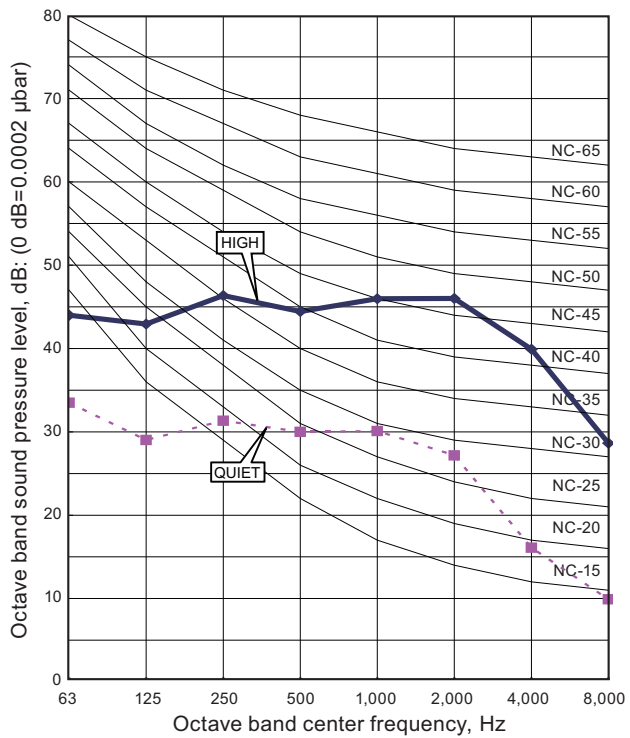

● Heating

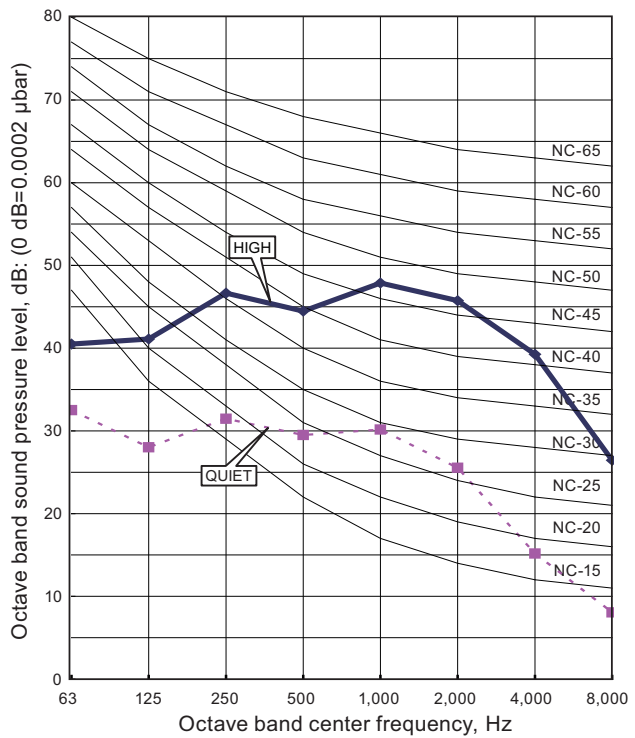

6-2. Sound level check point

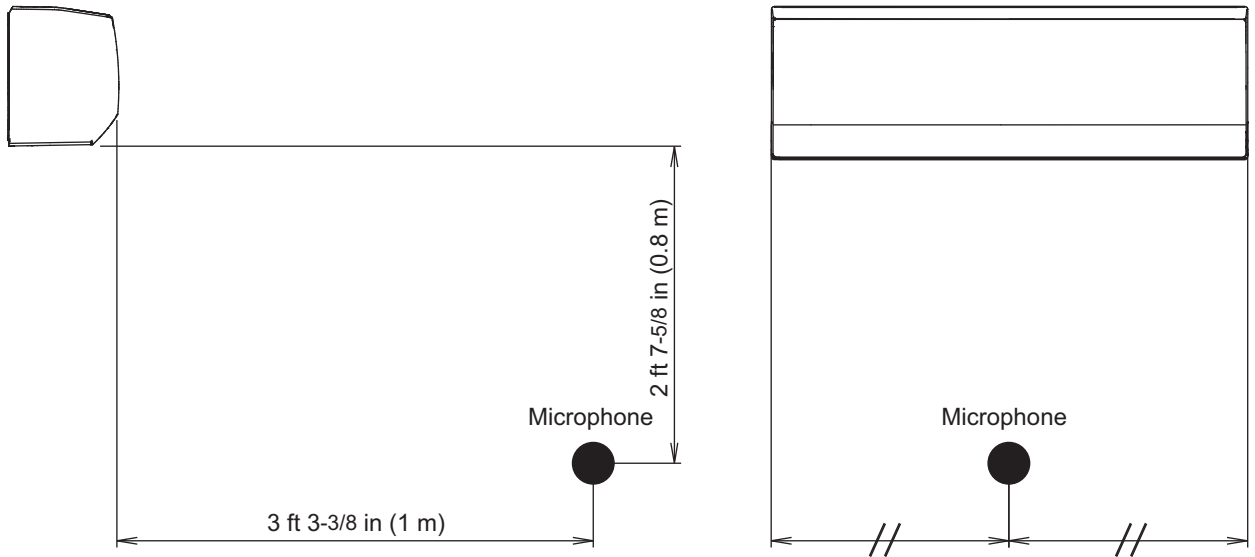

NOTE: Detailed shape of the actual indoor unit might be slightly different from the one illustrated above.

7. Safety devices

Type of protection	Protection form		Model	
			ASU18RLF	ASU24RLF
Circuit protection	Current fuse (PCB*)		250 V, 3.15 A	
Terminal protection	Current fuse		250 V, 3 A	
Fan motor protection	Thermistor protection	Activate	More than 185°F (85°C) Fan motor speed down	
		Reset	Less than 185°F (85°C) Fan motor speed recover	
	Power IC thermal shutdown protection	Activate	302±27°F (150±15°C) Fan motor stop	
		Reset	Less than 275°F (135°C) Fan motor restart	

*PCB: Printed Circuit Board

8. External input and output

With using external input and output functions, this product can be operated inter-connectedly with an external device.

Connector	Input	Output	Remarks
CN14	Control input	—	See external input/output settings for details.
CN16	—	Operation status output	

8-1. External input

With using external input function, some functions on this product can be controlled from an external device.

- "Operation/Stop" mode or "Forced stop" mode can be selected with function setting of indoor unit.
- A twisted pair cable (22AWG) should be used. Maximum length of cable is 492 ft (150 m).
- The wire connection should be separate from the power cable line.

■ Control input (Operation/Stop or Forced stop)

The air conditioner can be remotely operated by means of the following on-site work.

Unit operation is started at the following contents by adding the contact input of a commercial on/off switch to a connector on the external control PCB and turning it on.

Unit operation	Initial setting after power is on	Starting mode other than initial setting
Operation mode	Auto changeover	Mode at previous operation
Set temperature	76 °F (24 °C)	Temperature at previous operation
Airflow mode	AUTO	Mode at previous operation
Air direction (swing)	Standard air direction (swing OFF)	Air direction at previous operation

● Circuit diagram example

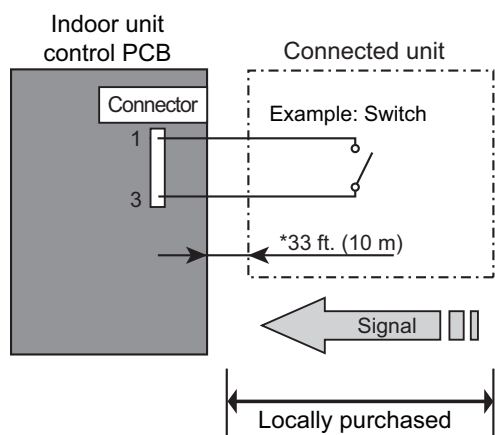

- Contact capacity: DC 24 V or more, 10 mA or more.
- *: Make the distance from the PCB to the connected unit within 33 ft (10 m).
- Use non-polar relays and switches.

- When function setting is "Operation/Stop" mode

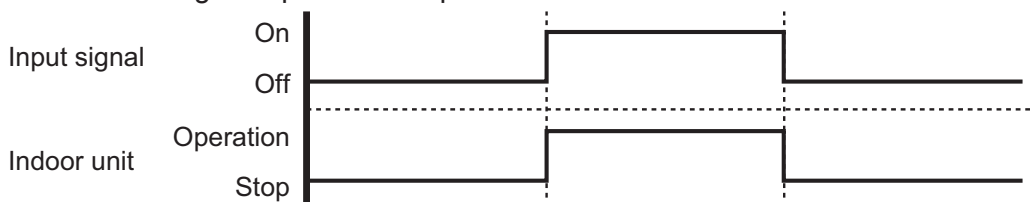

- When function setting is "Forced stop" mode

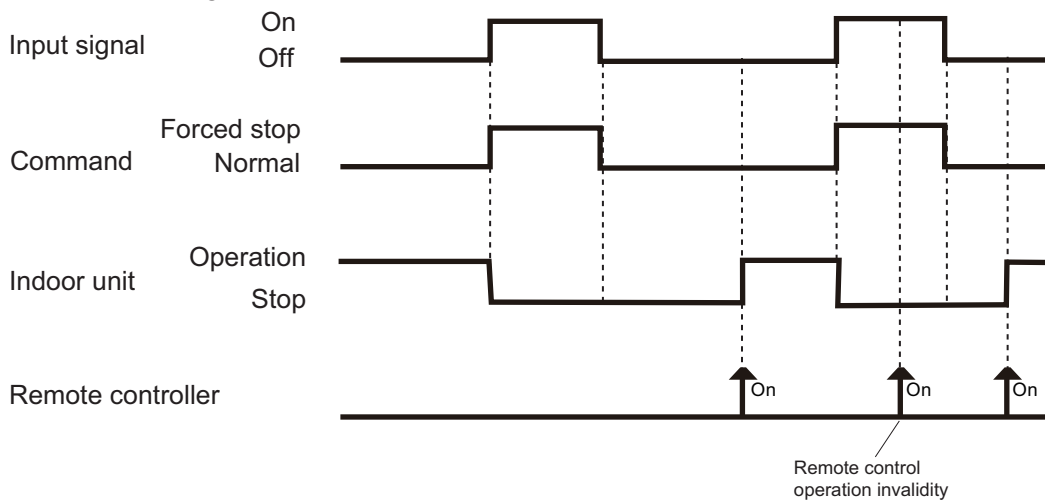

● Optional part

Part name	Model name	Exterior
External connect kit	UTY-XWZX	External input wire 

8-2. External output

With using external output function, operating status of this product can be transmitted to the external device, and also, this product can be inter-connected with the external device.

■ Operation status output

Air conditioner operation status signal can be output.

● Circuit diagram example

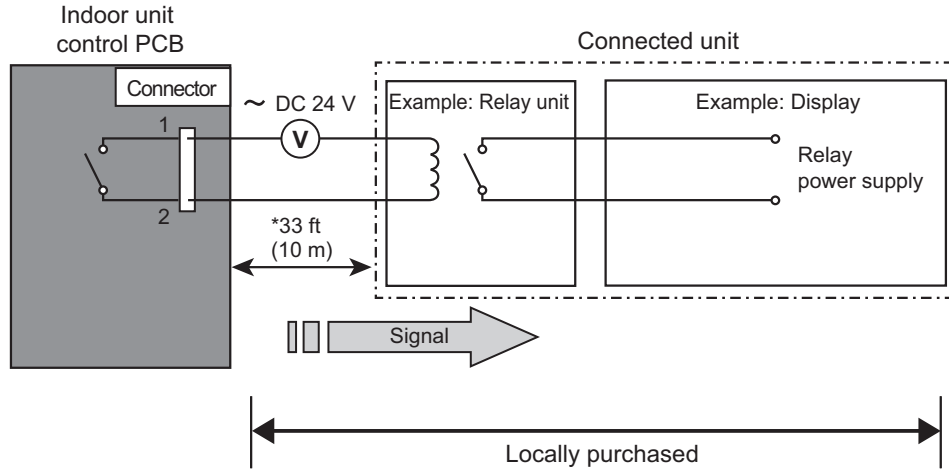

- *: Make the distance from the PCB to the connected unit within 33 ft (10 m).
- Relay spec: Max. DC 24 V, 10 mA to less than 500 mA.

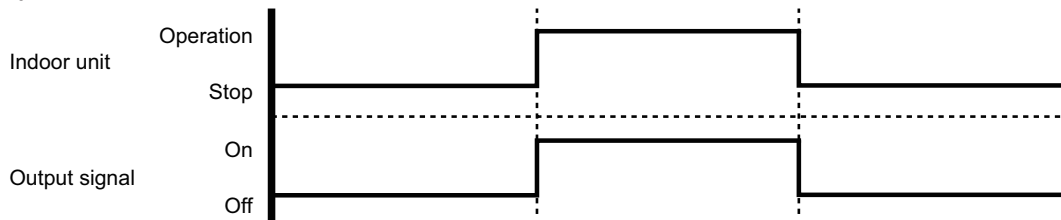

● Optional part

Part name	Model name	Exterior
External connect kit	UTY-XWZX	External output wire 

9. Remote controller

9-1. Wireless remote controller

Overview

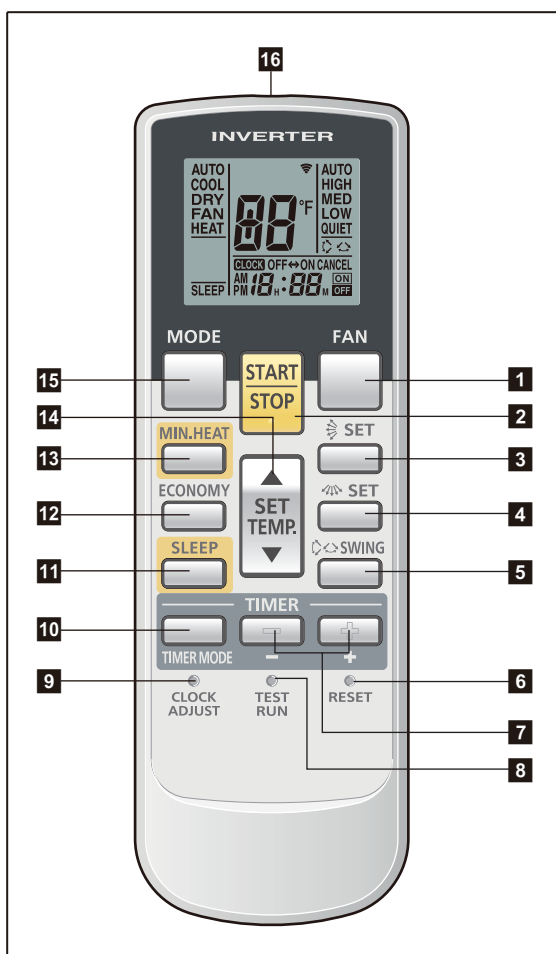

Display panel

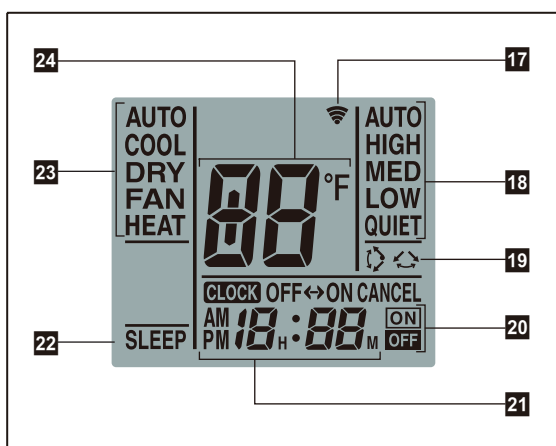

NOTE: Functions may differ by type of the indoor unit. For details, refer to the operation manual.

- 1 FAN button**
Selects the fan speed (AUTO, HIGH, MED, LOW, and QUIET).
- 2 START/STOP button**
Starts and stops operation.
- 3 SET button (vertical)**
Adjusts the vertical airflow direction.
- 4 SET button (horizontal)**
Adjusts the horizontal airflow direction.
- 5 SWING button**
Sets the automatic swing operation and selects swing mode (Up/down, Left/right, Up/down/left/right, and Stop swing).
- 6 RESET button**
Used when replacing batteries.
- 7 Timer set (- / +) button**
Sets the current time and on-off time.
- 8 TEST RUN button**
Only used for the initial test in the unit installation.
- 9 CLOCK ADJUST button**
Used for adjusting the clock.
- 10 TIMER MODE button**
Selects the timer mode (off timer, on timer, program timer, and timer reset).
- 11 SLEEP button**
Pressed to select sleep timer.
- 12 ECONOMY button**
- 13 MIN. HEAT button**
- 14 SET TEMP. (temperature) (▲ / ▼) button**
 - Sets desired temperature.
 - Sets remote controller custom code.
- 15 MODE button**
 - Switches operation mode (AUTO, COOL, DRY, FAN, and HEAT).
 - Starts/ends the remote controller custom code (max. 4 types) change.
- 16 Signal transmitter**
- 17 Signal transmit indicator**
- 18 Fan speed indicator**
- 19 Swing indicator**
- 20 Timer mode indicator**
- 21 Clock indicator**
- 22 Sleep indicator**
- 23 Operating mode indicator**
- 24 Temperature indicator**

■ Specifications

● Controller

Unit: in (mm)

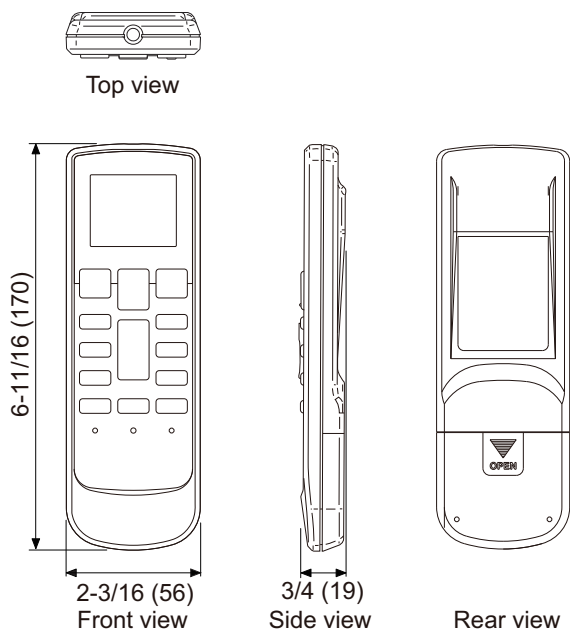

Size (H × W × D)	in (mm)	6-11/16 × 2-3/16 × 3/4 (170 × 56 × 19)
Weight	oz (g)	3 (85) (without batteries)

NOTE: Actual number of buttons might be different from the figure above.

● Holder

Unit: in (mm)

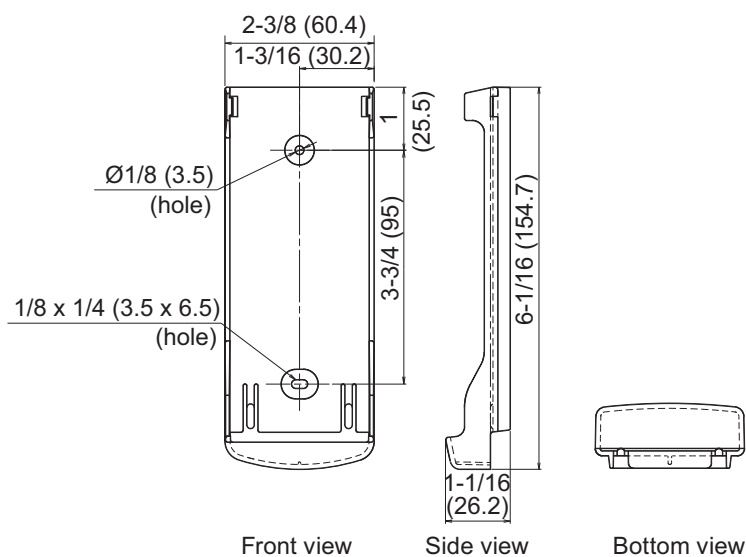

Size (H × W × D)	in (mm)	6-1/16 × 2-3/8 × 1-1/16 (154.7 × 60.4 × 26.2)
Weight	oz (g)	10 (28)

10. Function settings

To adjust the functions of this product according to the installation environment, various types of function settings are available.

NOTE: Incorrect settings can cause a product malfunction.

10-1. Function settings by using remote controller

Some function settings can be changed on the remote controller. After confirming the setting procedure and the content of each function setting, select appropriate functions for your installation environment.

NOTE: Incorrect settings can cause a product malfunction.

■ Setting procedure by using wireless remote controller

The function number and the associated setting value are displayed on the LCD of the remote controller. Follow the instructions written in the local setup procedure supplied with the remote controller, and select appropriate setting according to the installation environment.

Before connecting the power supply of the indoor unit, reconfirm following items:

- Piping air tight test and vacuuming have been performed firmly.
- There is no wiring mistake.

Then, connect the power supply of indoor unit.

Entering function setting mode:

While pressing the FAN button and SET TEMP. (▲) button simultaneously, press the RESET button to enter the function setting mode.

STEP 1: Setting the remote controller custom code

Use the following steps to select the custom code of the remote controller. (Note that the air conditioner cannot receive a custom code if the air conditioner has not been set for the custom code.)

The custom codes that are set through this process are applicable only to the signal in the function setting.

For details on how to set the custom codes through the normal process, refer to ["Custom code setting for wireless remote controller"](#) on page 28.

1. Press the SET TEMP. (▲) (▼) buttons to change the custom code between $\overline{A} \rightarrow \overline{B} \rightarrow \overline{C} \rightarrow \overline{D}$. Match the code on the display to the air conditioner custom code. (Initially set to \overline{A} .) If the custom code does not need to be selected, press the MODE button, and proceed to **STEP 2**.
2. Press the TIMER MODE button and check that the indoor unit can receive signals at the displayed custom code.
3. Press the MODE button to accept the custom code, and proceed to **STEP 2**.
4. After completing the function setting, be sure to disconnect the power supply and then reconnect it.

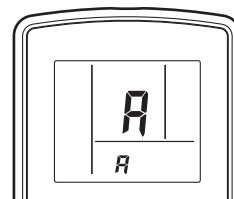

NOTES:

- The air conditioner custom code is set to " \overline{A} " prior to shipment.
- The remote controller resets to custom code " \overline{A} " when the batteries on the remote controller are replaced. If you use a custom code other than code " \overline{A} ", reset the custom code after replacing the batteries.
- If you do not know the air conditioner custom code setting, try each of the custom codes ($\overline{A} \rightarrow \overline{B} \rightarrow \overline{C} \rightarrow \overline{D}$) until you find the code that operates the air conditioner.

STEP 2: Selecting the function number and setting value

1. Press the SET TEMP. (▲) (▼) buttons to select the function number. To switch between the left and right digits, press the MODE button.
2. Press the FAN button to proceed the setting value. To return the function number selection, press the FAN button again.
3. Press the SET TEMP. (▲) (▼) buttons to select the setting value. To switch between the left and right digits, press the MODE button.
4. Press the TIMER MODE button, and START/STOP button, in the order listed to confirm the settings.
5. Press the RESET button to cancel the function setting mode.
6. After completing the function setting, be sure to disconnect the power supply and then reconnect it.

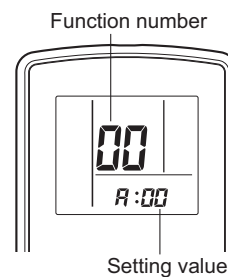

⚠ CAUTION

After disconnecting the power supply, wait 30 seconds or more before reconnecting it. The function setting will not become active unless the power supply is disconnected and then reconnected.

■ Contents of function setting

Each function setting listed in this section is adjustable in accordance with the installation environment.

NOTE: Setting will not be changed if invalid numbers or setting values are selected.

● Function setting list

	Function no.	Functions
1)	11	Filter sign
2)	30/31	Room temperature control for indoor unit sensor
3)	40	Auto restart
4)	42	Room temperature sensor switching
5)	44	Remote controller custom code
6)	46	External input control
7)	48	Room temperature sensor switching (Aux.)
8)	92/93	Room temperature control for wired remote controller sensor
9)	94	Fixed operation mode switching
10)	95	Heat insulation condition (building insulation)

1) Filter sign

Select appropriate intervals for displaying the filter sign on the indoor unit according to the estimated amount of dust in the air of the room.

If the indication is not required, select "No indication" (03).

Function number	Setting value	Setting description	Factory setting
11	00	Standard (400 hours)	
	01	Long interval (1,000 hours)	
	02	Short interval (200 hours)	
	03	No indication	◆

2) Room temperature control for indoor unit sensor

NOTE: Before performing this setting, refer to Function 95.

Depending on the installed environment, correction of the room temperature sensor may be required. Select the appropriate control setting according to the installed environment.

The temperature correction values show the difference from the Standard setting "00" (manufacturer's recommended value).

*When Function 95-01 (High insulation) is set, the Standard setting "00" will be the same as "No correction 0.0 °F (0.0 °C)" (01).

Function number		Setting value	Setting description	Factory setting	
30 (For cooling)	31 (For heating)	00	Standard setting*	◆	
		01	No correction 0.0 °F (0.0 °C)		
		02	-1 °F (-0.5 °C)	More cooling Less heating	
		03	-2 °F (-1.0 °C)		
		04	-3 °F (-1.5 °C)		
		05	-4 °F (-2.0 °C)		
		06	-5 °F (-2.5 °C)		
		07	-6 °F (-3.0 °C)		
		08	-7 °F (-3.5 °C)		
		09	-8 °F (-4.0 °C)		
		10	+1 °F (+0.5 °C)	Less cooling More heating	
		11	+2 °F (+1.0 °C)		
		12	+3 °F (+1.5 °C)		
		13	+4 °F (+2.0 °C)		
		14	+5 °F (+2.5 °C)		
		15	+6 °F (+3.0 °C)		
		16	+7 °F (+3.5 °C)		
17	+8 °F (+4.0 °C)				

3) Auto restart

Enables or disables automatic restart after a power interruption.

Function number	Setting value	Setting description	Factory setting
40	00	Enable	◆
	01	Disable	

NOTE: Auto restart is an emergency function such as for power outage etc. Do not attempt to use this function in normal operation. Be sure to operate the unit by remote controller or external device.

4) Room temperature sensor switching

(Only for wired remote controller)

When using the wired remote controller temperature sensor, change the setting to "Both" (01).

Function number	Setting value	Setting description	Factory setting
42	00	Indoor unit	◆
	01	Both	

00: Sensor on the indoor unit is active.

01: Sensors on both indoor unit and wired remote controller are active.

NOTE: Remote controller sensor must be turned on by using the remote controller.

5) Remote controller custom code

(Only for wireless remote controller)

The indoor unit custom code can be changed. Select the appropriate custom code.

Function number	Setting value	Setting description	Factory setting
44	00	A	◆
	01	B	
	02	C	
	03	D	

6) External input control

"Operation/Stop" mode or "Forced stop" mode can be selected.

Function number	Setting value	Setting description	Factory setting
46	00	Operation/Stop mode	◆
	01	(Setting prohibited)	
	02	Forced stop mode	

7) Room temperature sensor switching (Aux.)

To use the temperature sensor on the wired remote controller only, change the setting to "Wired remote controller" (01).

This function will only work if the function setting 42 is set at "Both" (01).

When the setting value is set to "Both" (00), more suitable control of the room temperature is possible by setting function setting 30 and 31 too.

Function number	Setting value	Setting description	Factory setting
48	00	Both	◆
	01	Wired remote controller	

8) Room temperature control for wired remote controller sensor

NOTE: Before performing this setting, refer to Function 95.

Depending on the installed environment, correction of the room temperature sensor may be required. Select the appropriate control setting according to the installed environment.

To change this setting, set Function 42 to "Both" (01).

Ensure that the thermo sensor icon is displayed on the remote controller screen.

Function number		Setting value	Setting description	Factory setting	
92 (For cooling)	93 (For heating)	00	No correction 0.0 °F (0.0 °C)	◆	
		01	No correction 0.0 °F (0.0 °C)		
		02	-1 °F (-0.5 °C)	More cooling Less heating	
		03	-2 °F (-1.0 °C)		
		04	-3 °F (-1.5 °C)		
		05	-4 °F (-2.0 °C)		
		06	-5 °F (-2.5 °C)		
		07	-6 °F (-3.0 °C)		
		08	-7 °F (-3.5 °C)		
		09	-8 °F (-4.0 °C)		
		10	+1 °F (+0.5 °C)	Less cooling More heating	
		11	+2 °F (+1.0 °C)		
		12	+3 °F (+1.5 °C)		
		13	+4 °F (+2.0 °C)		
		14	+5 °F (+2.5 °C)		
		15	+6 °F (+3.0 °C)		
		16	+7 °F (+3.5 °C)		
17	+8 °F (+4.0 °C)				

9) Fixed operation mode switching

Sets the operation mode to heat pump, heating only, or cooling only.

Function number	Setting value	Setting description	Factory setting
94	00	Heat pump	◆
	01	Heating only	
	02	Cooling only	

10) Heat insulation condition (building insulation)

Heat insulation conditions differ according to the installed environment.

"Standard insulation" (00) allows system to rapidly respond to the cooling or heating load changes.

"High insulation" (01) is when the heat insulation structure of the building is high and does not require system to rapidly respond to cooling or heating load changes.

When "High insulation" (01) is selected:

- Overheating (overcooling) is prevented at the start-up.
- All room-temperature control settings (Function 30, 31, 92, and 93) will reset to "No correction 0.0 °F (0.0 °C)".

Function number	Setting value	Setting description	Factory setting
95	00	Standard insulation	◆
	01	High insulation	

NOTE: When changing Function 95, perform this setting before other room-temperature control settings (Function 30, 31, 92, and 93). If Function 95 is not set first, room-temperature control settings (Function 30, 31, 92, and 93) will be reset and you must re-do them again.

■ Custom code setting for wireless remote controller

To interconnect the air conditioner and the wireless remote controller, assignment of the custom code for the wireless remote controller is required.

NOTE: Air conditioner cannot receive a custom code if the air conditioner has not been set for the custom code.

1. Press the START/STOP button until only the clock is displayed on the remote controller display.
2. Press the MODE button for at least 5 seconds to display the current custom code. (Initially set to A .)

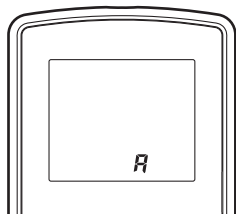







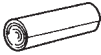
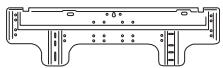

3. Press the SET TEMP. (\blacktriangle or \blacktriangledown) button to change the custom code between $\text{A} \rightarrow \text{b} \rightarrow \text{c} \rightarrow \text{d}$. Match the code on the display to the air conditioner custom code.
4. Press the MODE button again to return to the clock indicator. The custom code will be changed.

NOTES:

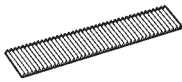

- If no button is pressed within 30 seconds after the custom code is displayed, the system returns to the original clock indicator. In this case, start again from step 1.
- The air conditioner custom code is set to A prior to shipment. To change the custom code, contact your retailer.
- The remote controller resets to custom code A when the batteries in the remote controller are replaced. If you use a custom code other than code A , reset the appropriate custom code after replacing the batteries. If you do not know the assigned code for the air conditioner, try each of the custom code ($\text{A} \rightarrow \text{b} \rightarrow \text{c} \rightarrow \text{d}$) until you find the code which operates the air conditioner.

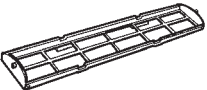
11. Accessories

Part name	Exterior	Q'ty	Part name	Exterior	Q'ty
Operating manual		1	Drain hose insulation		1
Installation manual		1	Cloth tape		1
Wall hook bracket		1	Tapping screw (large), M4 × 25 mm		8
Remote controller		1	Tapping screw (small), M3 × 12 mm		2
Battery		2	Air cleaning filter		2
Remote controller holder		1	Air cleaning filter frame		2

12. Optional parts

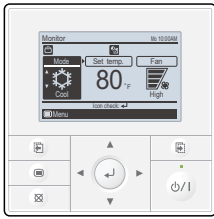
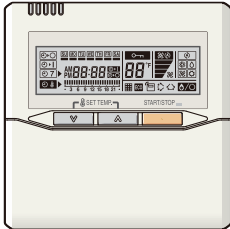
12-1. Controllers

Exterior	Part name	Model name	Summary
	Wired remote controller	UTY-RVNUM	Large and full-dot liquid crystal screen, wide and large keys easy to press, user-intuitive arrow key. Wire type: Polar 3-wire
	Wired remote controller	UTY-RNNUM	Room temperature can be controlled by detecting the temperature accurately with built-in thermo sensor. Wire type: Polar 3-wire
	Simple remote controller	UTY-RSNUM	Compact remote controller concentrates on the basic functions such as Start/Stop, fan control, temperature setting, and operation mode. Wire type: Polar 3-wire

NOTE: Available functions may differ by the remote controller. For details, refer to the operation manual.

12-2. Others

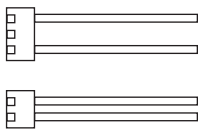
Exterior	Part name	Model name	Summary
	External connect kit	UTY-XWZX	Use to connect with various peripheral devices and air conditioner PCB.

Part 2. OUTDOOR UNIT

**SINGLE TYPE:
AOU18RLXFWH
AOU24RLXFWH**

1. Specifications

OUTDOOR UNIT
AOU18, 24RLXFWH

Type			Inverter heat pump	
Model name			AOU18RLXFWH	AOU24RLXFWH
Power supply			208/230 V ~ 60 Hz	
Available voltage range			187—253 V	
Starting current			A	
			8.0	
Fan	Airflow rate	Cooling	1,489 (2,530)	
		Heating	2,001 (3,400)	
	Type × Q'ty	CFM (m ³ /h)	1,489 (2,530)	
Motor output			Propeller fan × 1	
			100	
Sound pressure level *1		Cooling	47	
		Heating	54	
			50	
Heat exchanger type	Dimensions (H × W × D)	in	31-7/16 × 35-7/16 × 1-7/16	
		mm	798 × 900 × 36.4	
	Fin pitch	FPI	20	
	Rows × Stages		2 × 38	
	Pipe type		Copper	
	Fin type	Type (Material)	Corrugate (Aluminum)	
	Surface treatment	Corrosion resistance (Blue fin)		
Compressor	Type × Q'ty	Hermetic motor compressor × 1		
	Motor output	W	2,100	
Refrigerant	Type	R410A		
	Charge	lb oz	4 lb 10.1 oz	
		g	2,100	
Refrigerant oil	Type	POE (RB68)		
	Amount	in ³ (cm ³)	48.8 (800)	
Enclosure	Material	Steel sheet		
	Color	Beige Approximate color of MUNSELL 10YR7.5/1.0		
Dimensions (H × W × D)	Net	in	32-11/16 × 35-7/16 × 13	
		mm	830 × 900 × 330	
	Gross	in	39-3/8 × 41-5/16 × 17-1/2	
mm		1,000 × 1,050 × 445		
Weight	Net	lb (kg)	135 (61)	
	Gross		152 (69)	
Connection pipe	Size	Liquid	Ø 3/8 (Ø 9.52)	
		Gas	Ø 5/8 (Ø 15.88)	
	Method	Flare		
	Pre-charge length	ft (m)	66 (20)	
	Max. length		164 (50)	
	Max. height difference		98 (30)	
Operation range	Cooling	°F (°C)	-5 to 115 (-20 to 46)	
	Heating		-15 to 75 (-26 to 24)	
Drain hose	Material	LDPE		
	Size	mm	Ø 13.0 (I. D.), Ø 16.0 to Ø 16.7 (O. D.)	

NOTES:

- Specifications are based on the following conditions:
 - Cooling: Indoor temperature of 80 °FDB (26.67 °CDB) / 67 °FWB (19.44 °CWB), and outdoor temperature of 95 °FDB (35 °CDB) / 75 °FWB (23.9 °CWB).
 - Heating: Indoor temperature of 70 °FDB (21.11 °CDB) / 59 °FWB (15 °CWB), and outdoor temperature of 47 °FDB (8.33 °CDB) / 43 °FWB (6.11 °CWB).
 - Pipe length: 24 ft 6 in (7.5 m), Height difference: 0 ft (0 m). (Between outdoor unit and indoor unit.)
- Protective function might work when using it outside the operation range.
- *1: Sound pressure level
 - Measured values in manufacturer's anechoic chamber.
 - Because of the surrounding sound environment, the sound levels measured in actual installation conditions might be higher than the specified values here.

2. Dimensions

2-1. Models: AOU18RLXFWH and AOU24RLXFWH

Unit: in (mm)

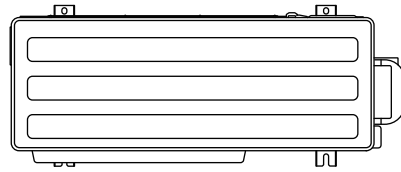

Top view

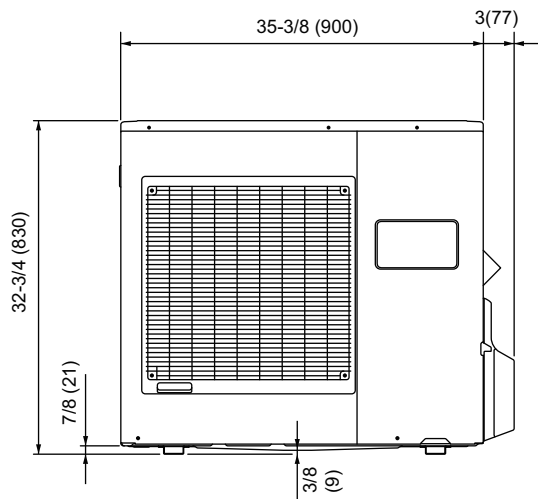

Front view

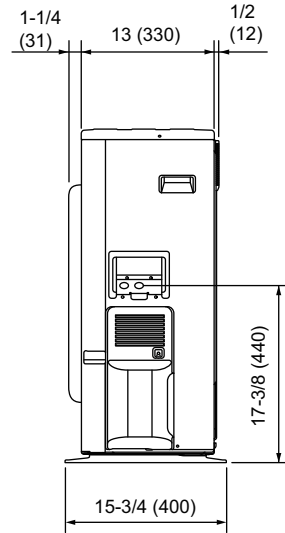

Side view

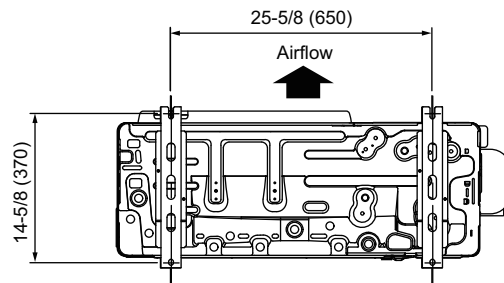

Bottom view

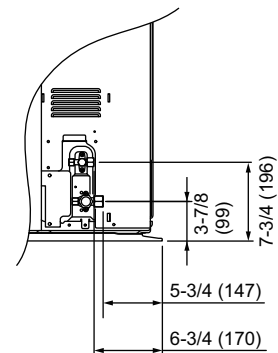

3. Installation space

3-1. Models: AOU18RLXFWH and AOU24RLXFWH

■ Space requirement

Provide sufficient installation space for product safety.

● Single outdoor unit installation

- When the upper space is open:

Unit: in (mm)

When there are obstacles at the rear only.

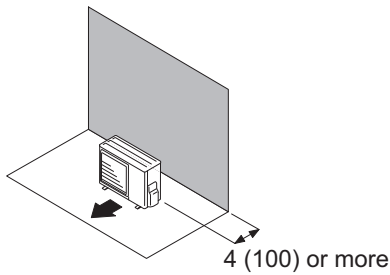

When there are obstacles at the rear and sides.

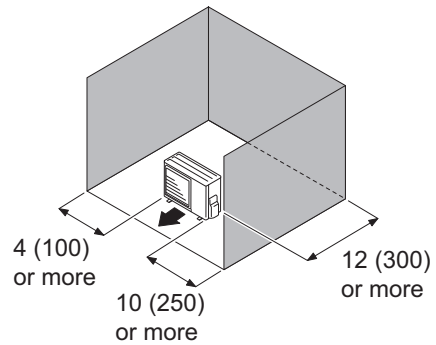

When there are obstacles at the front only.

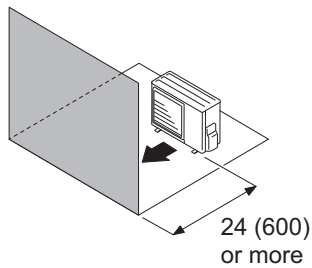

When there are obstacles at the front and rear.

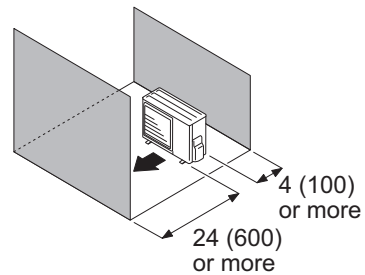

- When there is an obstruction in the upper space:

Unit: in (mm)

When there are obstacles at the rear and above.

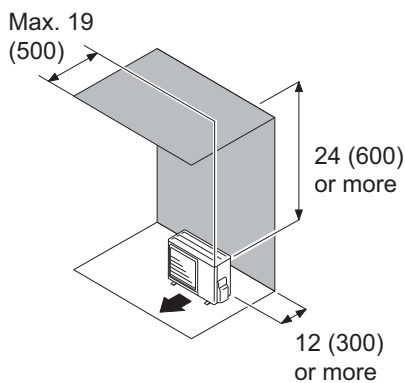

When there are obstacles at the rear, sides, and above.

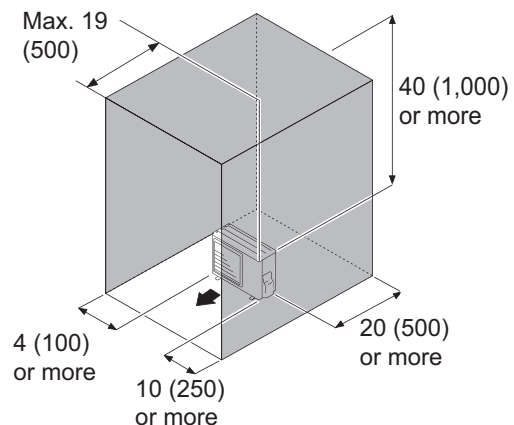

● Multiple outdoor unit installation

- When the upper space is open:

Unit: in (mm)

When there are obstacles at the rear only.

When there are obstacles at the front only.

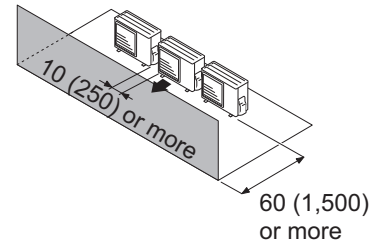
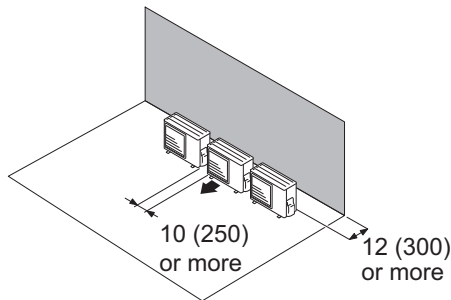

When there are obstacles at the front and rear.

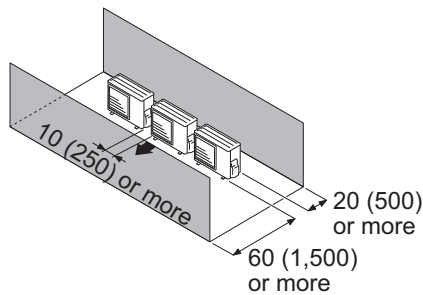

- When there is an obstruction in the upper space:

Unit: in (mm)

When there are obstacles at the rear and above.

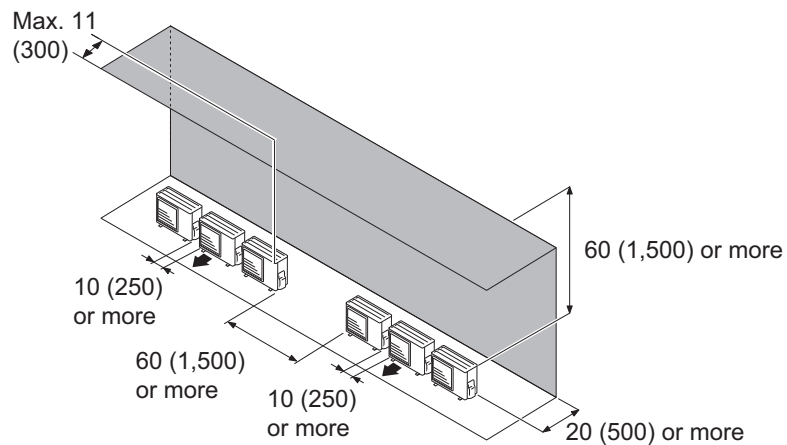

● Outdoor unit installation in multi-row

Unit: in (mm)

Single parallel unit arrangement

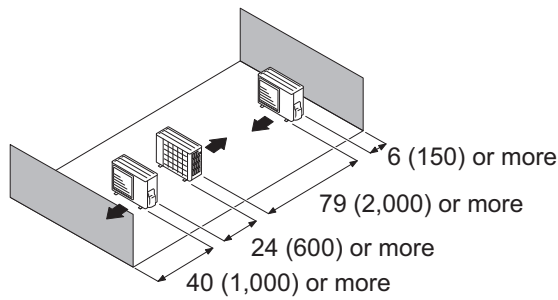

Multiple parallel unit arrangement

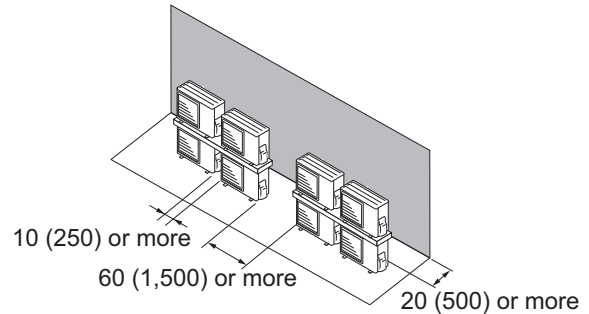
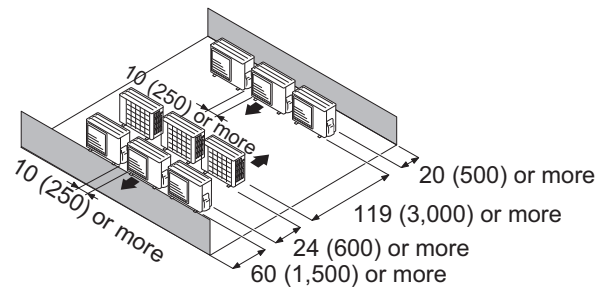

NOTES:

- If the space is larger than stated above, the condition will be the same as when there is no obstacle.
- Height above the floor level should be 2 in (50 mm) or more.
- When installing the outdoor unit, be sure to open the front and left side to obtain better operation efficiency.

⚠ CAUTION

- Do not install the outdoor unit in two-stage where the drain water could freeze. Otherwise the drainage from the upper unit may form ice and cause a malfunction of the lower unit.
- When the outdoor temperature is 32 °F (0 °C) or less, do not use the accessory drain pipe and drain cap. If the drain pipe and drain cap are used, the drain water in the pipe may freeze in extremely cold climate. (For reverse cycle model only.)
- In area with heavy snowfall, if the inlet and outlet of the outdoor unit is blocked with snow, it might become difficult to get warm, and it is likely to cause product malfunction. Construct a canopy and a pedestal, or place the unit on a high stand that is locally installed.

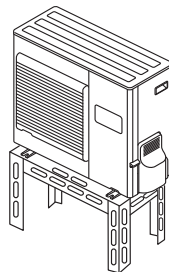

4. Refrigerant circuit

4-1. Models: AOU18RLXFWH and AOU24RLXFWH

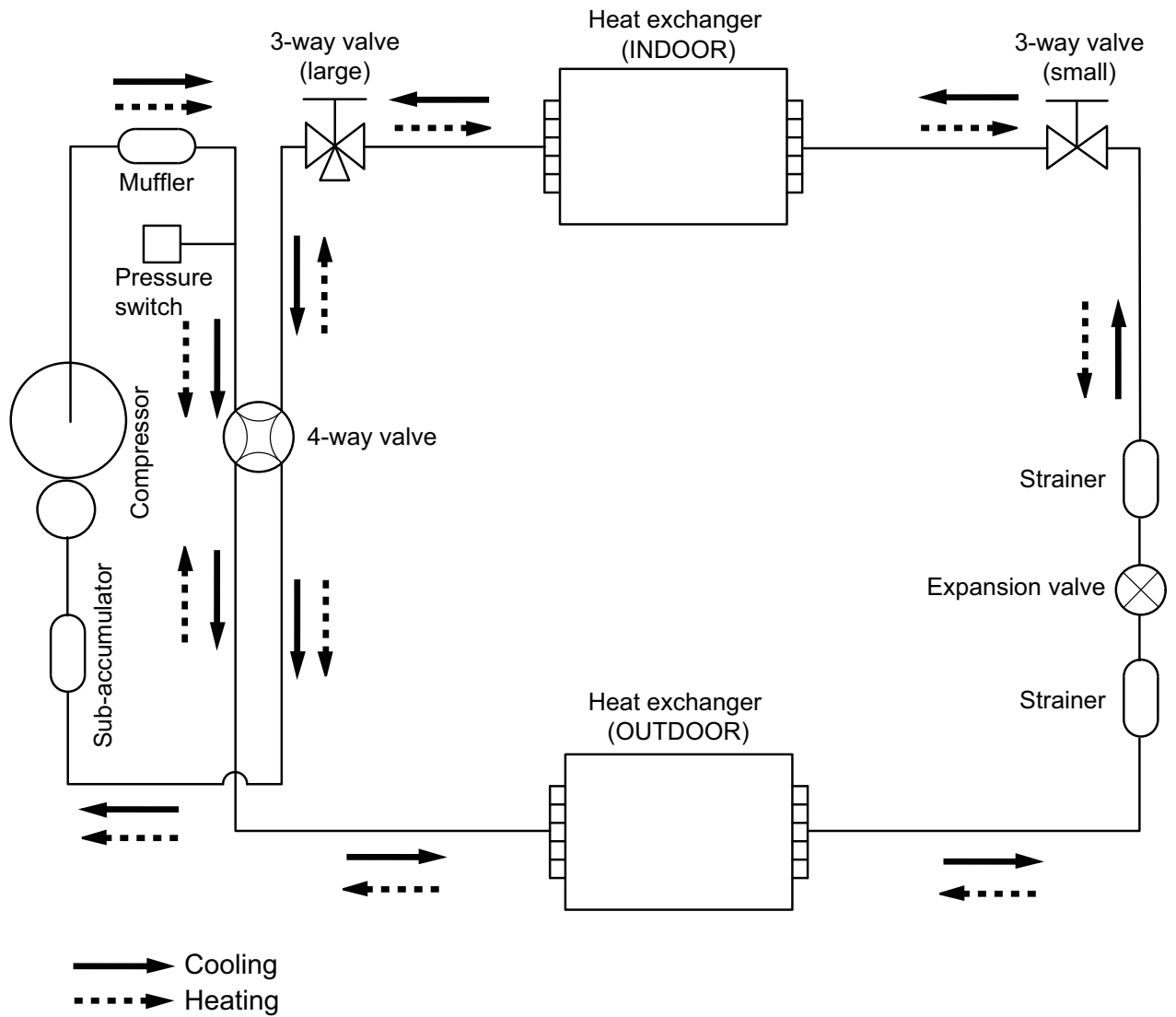

5. Wiring diagrams

5-1. Model: AOU18RLXFWH

OUTDOOR UNIT
AOU18, 24RLXFWH

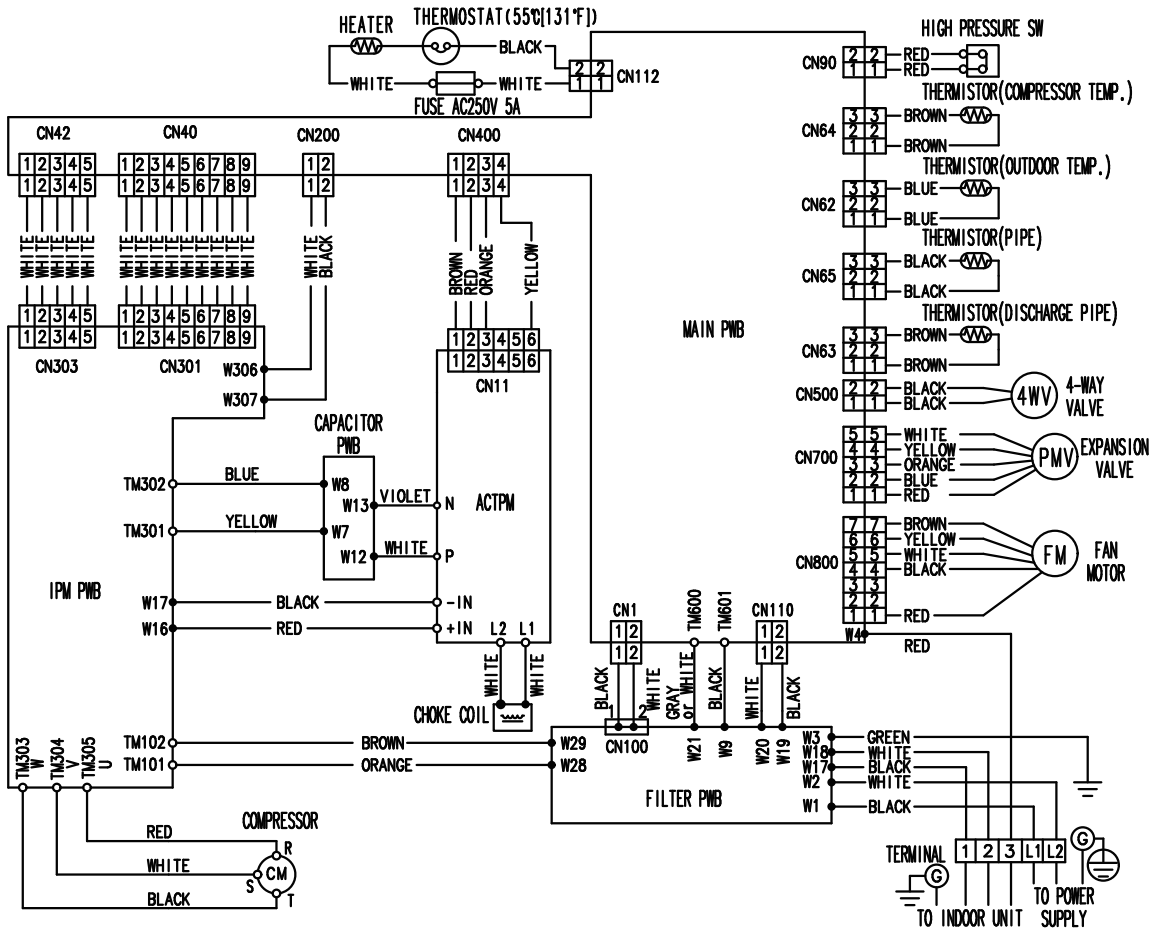

5-2. Model: AOU24RLXFWH

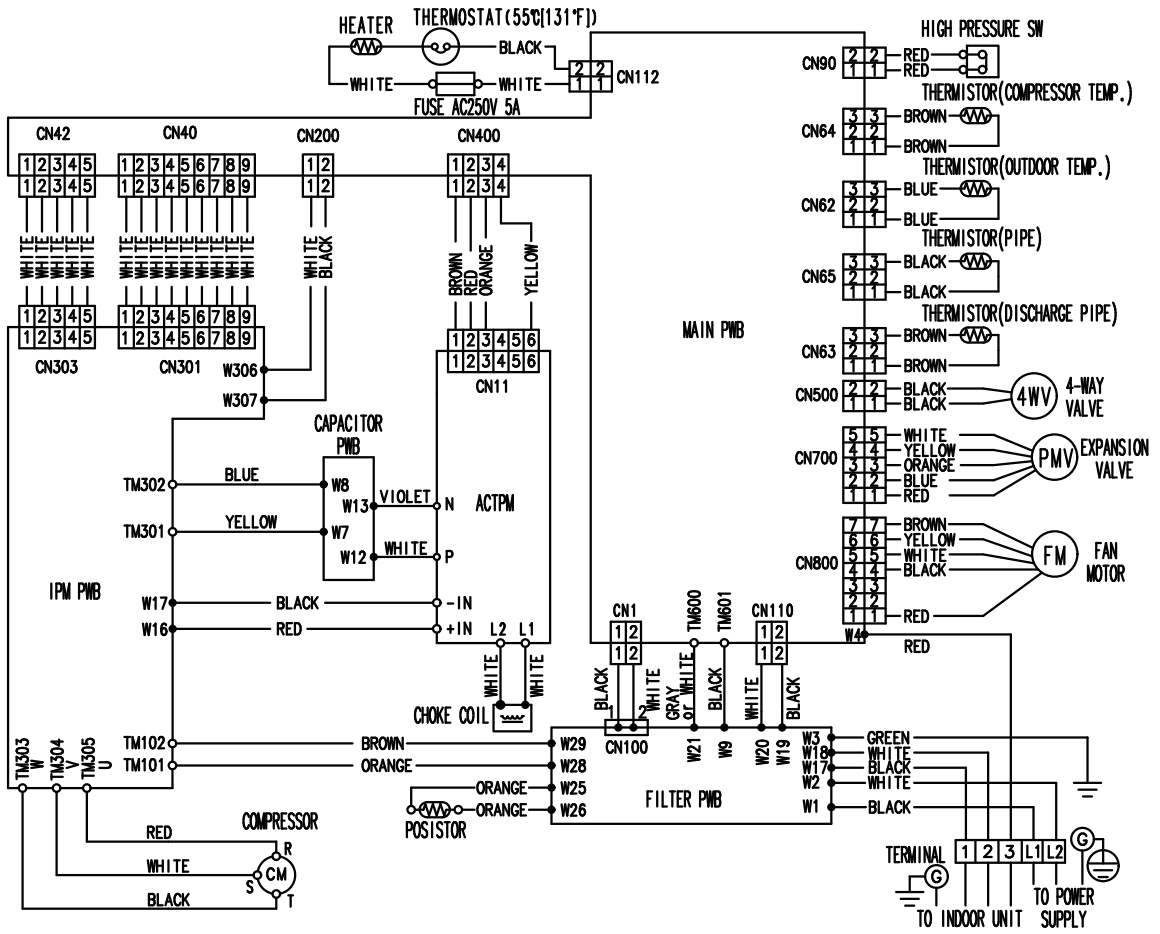

OUTDOOR UNIT
AOU18, 24RLXFWH

6. Capacity compensation rate for pipe length and height difference

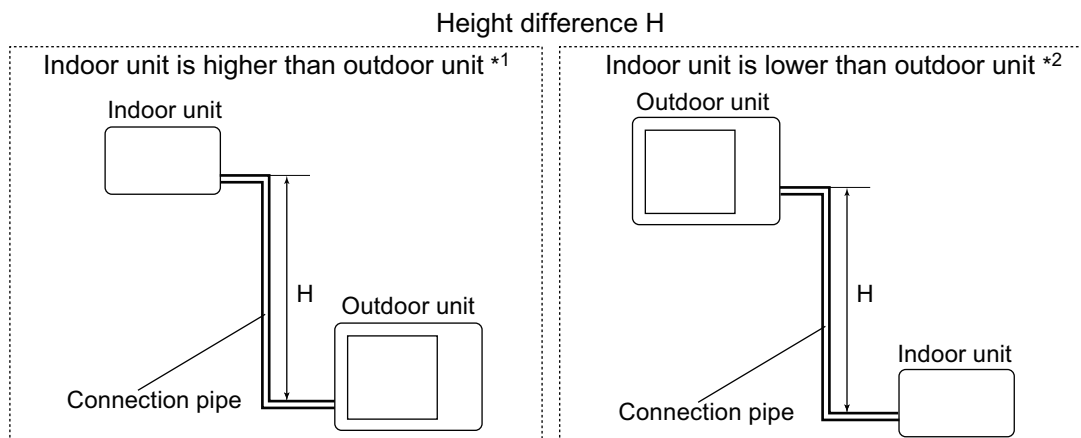

6-1. Models: AOU18RLXFWH and AOU24RLXFWH

NOTE: Values mentioned in the table are calculated based on the maximum capacity.

COOLING		Pipe length								
		m	5	7.5	10	20	30	40	50	
			ft	16	24	32	65	98	131	164
Height difference H	Indoor unit is higher than outdoor unit *1	30	98	-	-	-	-	0.932	0.929	0.924
		20	65	-	-	-	0.945	0.947	0.945	0.940
		10	32	-	-	0.984	0.961	0.963	0.960	0.956
		7.5	24	-	0.988	0.988	0.965	0.967	0.964	0.959
		5	16	0.992	0.992	0.992	0.968	0.971	0.968	0.963
	0	0	0.998	1.000	1.000	0.976	0.979	0.976	0.971	
Indoor unit is lower than outdoor unit *2	-5	-16	0.998	1.000	1.000	0.976	0.979	0.976	0.971	
	-7.5	-24	-	1.000	1.000	0.976	0.979	0.976	0.971	
	-10	-32	-	-	1.000	0.976	0.979	0.976	0.971	
	-20	-65	-	-	-	0.976	0.979	0.976	0.971	
	-30	-98	-	-	-	-	0.979	0.976	0.971	

HEATING		Pipe length								
		m	5	7.5	10	20	30	40	50	
			ft	16	24	32	65	98	131	164
Height difference H	Indoor unit is higher than outdoor unit *1	30	98	-	-	-	-	0.816	0.756	0.686
		20	65	-	-	-	0.872	0.816	0.756	0.686
		10	32	-	-	0.991	0.872	0.816	0.756	0.686
		7.5	24	-	1.000	0.991	0.872	0.816	0.756	0.686
		5	16	0.986	1.000	0.991	0.872	0.816	0.756	0.686
	0	0	0.986	1.000	0.991	0.872	0.816	0.756	0.686	
Indoor unit is lower than outdoor unit *2	-5	-16	0.981	0.995	0.986	0.868	0.812	0.752	0.683	
	-7.5	-24	-	0.993	0.983	0.866	0.810	0.750	0.681	
	-10	-32	-	-	0.981	0.864	0.808	0.748	0.679	
	-20	-65	-	-	-	0.855	0.799	0.740	0.672	
	-30	-98	-	-	-	-	0.791	0.733	0.665	

7. Additional charge calculation

7-1. Models: AOU18RLXFWH and AOU24RLXFWH

Refrigerant type		R410A
Refrigerant amount	lb oz	4 lb 10.1 oz
	g	2,100

■ Refrigerant charge

Total pipe length	ft	66 or less	98	131	164 (Max.)	0.43 oz/ft (40 g/m)
	m	20 or less	30	40	50 (Max.)	
Additional charge	oz	0	14.1	28.2	42.3	
	g	0	400	800	1,200	

8. Airflow

8-1. Model: AOU18RLXFWH

● Cooling

m ³ /h	2,530
l/s	703
CFM	1,489

● Heating

m ³ /h	2,530
l/s	703
CFM	1,489

8-2. Model: AOU24RLXFWH

● Cooling

m ³ /h	3,400
l/s	944
CFM	2,001

● Heating

m ³ /h	3,600
l/s	1,000
CFM	2,119

9. Operation noise (sound pressure)

9-1. Noise level curve

■ Model: AOU18RLXFWH

● Cooling

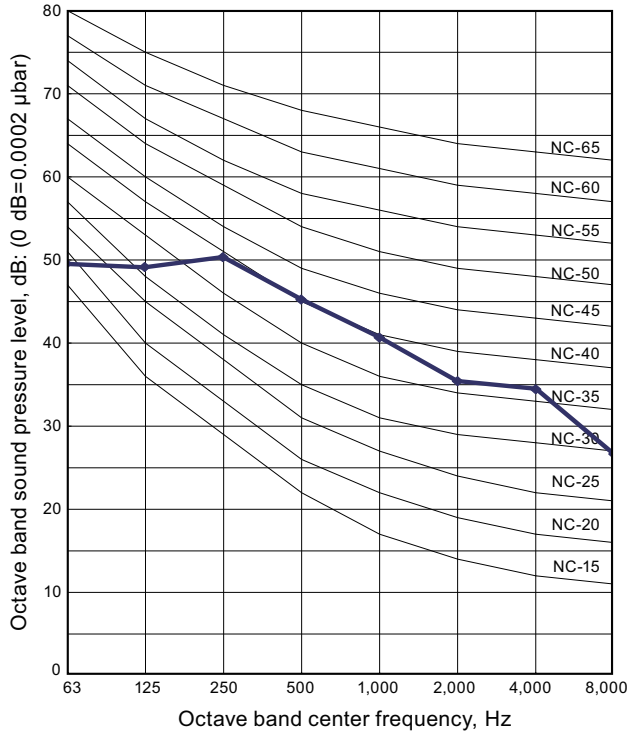

● Heating

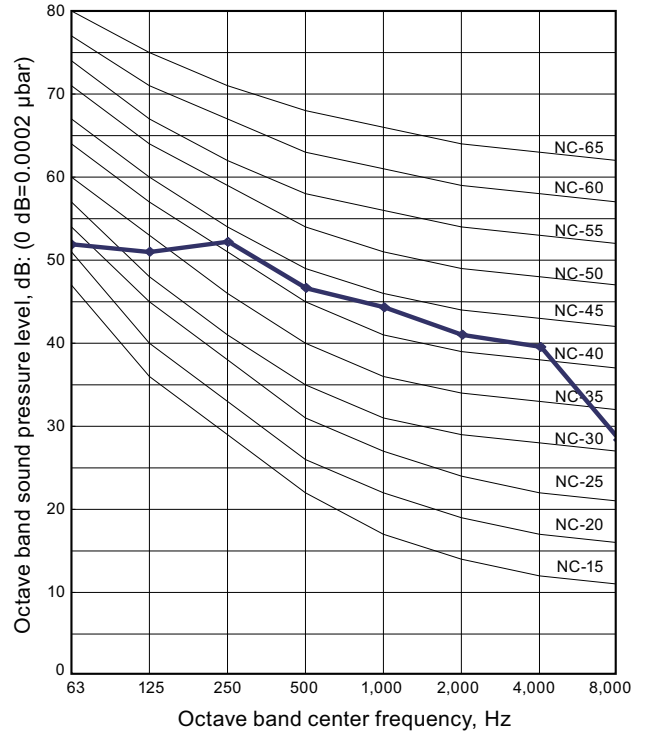

■ Model: AOU24RLXFWH

● Cooling

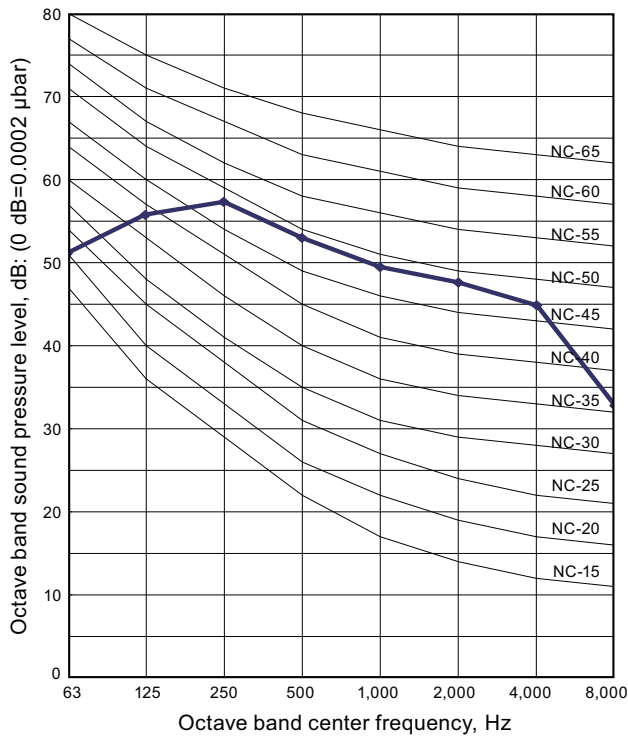

● Heating

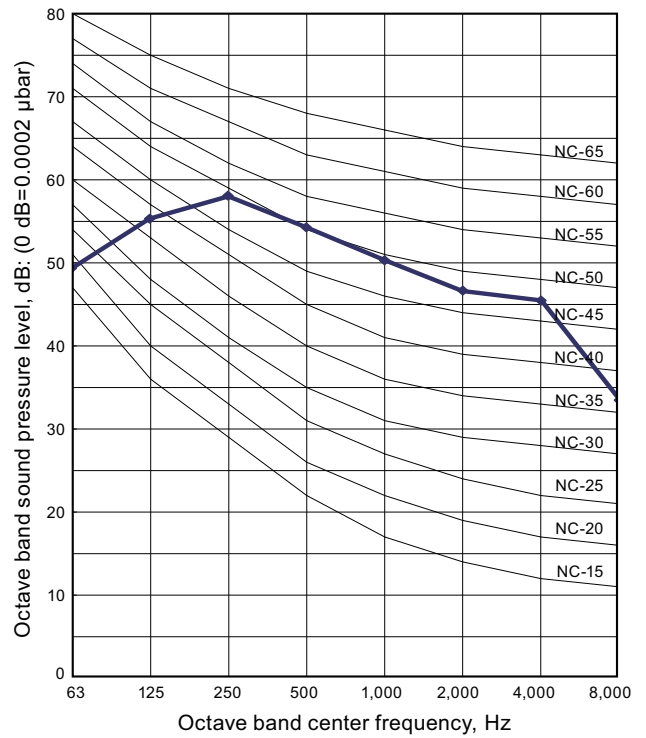

OUTDOOR UNIT
AOU18, 24RLXFWH

9-2. Sound level check point

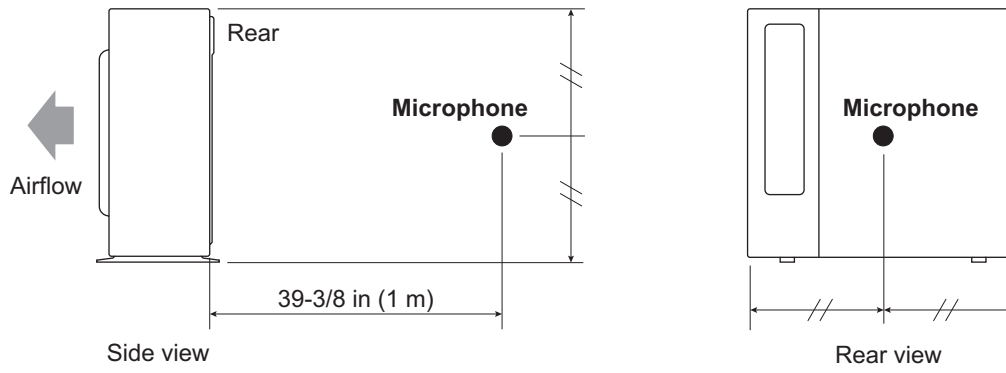

NOTE: Detailed shape of the actual outdoor unit might be slightly different from the one illustrated above.

10. Electrical characteristics

Model name			AOU18RLXFWH	AOU24RLXFWH
Power supply	Voltage	V	208/230~	
	Frequency	Hz	60	
MCA *1		A	17.0	18.0
Starting current		A	7.8	8.6
Wiring spec. *2	MAX. CKT. BKR *3	A	20	
	Power cable	AWG	12	
	Connection cable *4	AWG	14	
	Limited wiring length	ft (m)	167 (51)	

*1: Minimum Circuit Ampacity (Calculation based on UL1995)

*2: Selected sample based on Japan Electrotechnical Standards and Codes Committee E0005.
As the regulations of wire size and circuit breaker differ in each country or region, select appropriate devices complied to the regional standard.

*3: Maximum Circuit Breaker





*4: Limit voltage drop to less than 2%. If voltage drop is 2% or more, increase cable conductor size.

11. Safety devices

OUTDOOR UNIT
 AOU18, 24RLXFWH

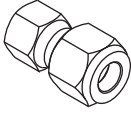
Type of protection	Protection form		Model	
			AOU18RLXFWH	AOU24RLXFWH
Circuit protection	Current fuse (Filter PCB)		250 V, 5 A × 2	
	Current fuse (Main PCB)		250 V, 3.15 A	
	Current fuse (Out of PCB)		250 V, 5 A	
Fan motor protection	Thermal protection	Activate	302±27 °F (150±15 °C) Fan motor stop	
		Reset	248±27 °F (120±15 °C) Fan motor restart	
Compressor protection	Terminal protection program (Compressor temp.)	Activate	226 °F (108 °C) Compressor stop	
		Reset	176 °F (80 °C) Compressor restart	
	Thermal protection program (Discharge temp.) (COOL or DRY mode)	Activate	230 °F (110 °C) Compressor stop	
		Reset	After 7 minutes Compressor restart	
High pressure protection	Pressure switch	Activate	4.2±0.1 MPa Compressor stop	
		Reset	3.2±0.15 MPa Compressor restart	

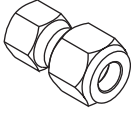
12. Accessories

Part name	Exterior	Q'ty	Part name	Exterior	Q'ty
Installation manual		1	Adapter, 12.7 (1/2)→15.88 (5/8) [mm (in)] (Only for 18 model)		1
Drain pipe		1	Adapter, 6.35 (1/4)→9.52 (3/8) [mm (in)]		1
Drain cap		5			