

**SPLIT TYPE
ROOM AIR CONDITIONER
WALL MOUNTED^{type}
INVERTER**

SERVICE INSTRUCTION

Models	Indoor unit	Outdoor unit
	ASU09RL2	AOU09RL2
	ASU12RL2	AOU12RL2

Refrigerant
R410A

CONTENTS

1. DESCRIPTION OF EACH CONTROL OPERATION

1. COOLING OPERATION.....	01-01
2. HEATING OPERATION.....	01-02
3. DRY OPERATION.....	01-02
4. AUTO CHANGEOVER OPERATION.....	01-03
5. INDOOR FAN CONTROL.....	01-04
6. OUTDOOR FAN CONTROL.....	01-06
7. LOUVER CONTROL.....	01-07
8. COMPRESSOR CONTROL.....	01-08
9. TIMER OPERATION CONTROL.....	01-09
10. PREVENT TO RESTART FOR 3 MINUTES (3 MINUTES ST).....	01-11
11. FOUR-WAY VALVE EXTENSION SELECT.....	01-11
12. AUTO RESTART.....	01-11
13. MANUAL AUTO OPERATION (Indoor unit body operation).....	01-11
14. FORCED COOLING OPERATION.....	01-12
15. COMPRESSOR PREHEATING.....	01-12
16. ECONOMY OPERATION.....	01-12
17. POWERFUL OPERATION.....	01-12
18. DEFROST OPERATION CONTROL.....	01-13
19. OFF DEFROST OPERATION CONTROL.....	01-15
20. VARIOUS PROTECTIONS.....	01-16

2. TROUBLE SHOOTING

2-1 ERROR DISPLAY.....	02-01
2-2 TROUBLE SHOOTING WITH ERROR CODE.....	02-02
2-3 TROUBLE SHOOTING WITH NO ERROR CODE.....	02-21
2-4 SERVICE PARTS INFORMATION.....	02-26

3. APPENDING DATA

3-1 FUNCTION SETTING.....	03-01
3-1-1 INDOOR UNIT.....	03-01
3-1-2 Procedures to change the Function Setting for wireless RC.....	03-03
3-2 Thermistor Resistance Values.....	03-06
3-2-1 INDOOR UNIT.....	03-06
3-2-2 OUTDOOR UNIT.....	03-06

WALL MOUNTED type INVERTER

1 . DESCRIPTION OF EACH CONTROL OPERATION

1. COOLING OPERATION

A sensor (room temperature thermistor) built in the indoor unit body will usually perceive difference or variation between a set temperature and present room temperature, and controls the operation frequency of the compressor.

- * If the room temperature is 2°C(4°F) higher than a set temperature, the compressor operation frequency will attain to maximum performance.
- * If the room temperature is some degrees lower than a set temperature, the compressor will be stopped.
- * When the room temperature is between +2°C(4°F) to -2.5°C(-5°F) of the setting temperature, the compressor frequency is controlled within the range shown in Table1. However, the maximum frequency is limited in the range shown in Fig.1 based on the indoor fan mode and the outdoor temperature.

(Table 1 : Compressor frequency range)

	Minimum frequency	Maximum frequency I	Maximum frequency II
AOU09RL2	18rps	57rps	80rps
AOU12RL2		80rps	96rps

When the compressor operates for 30 minutes continuously at over the maximum frequency II, the maximum frequency is changed from Maximum Frequency II to Maximum Frequency I

(Fig.1 : Outdoor temperature zone)

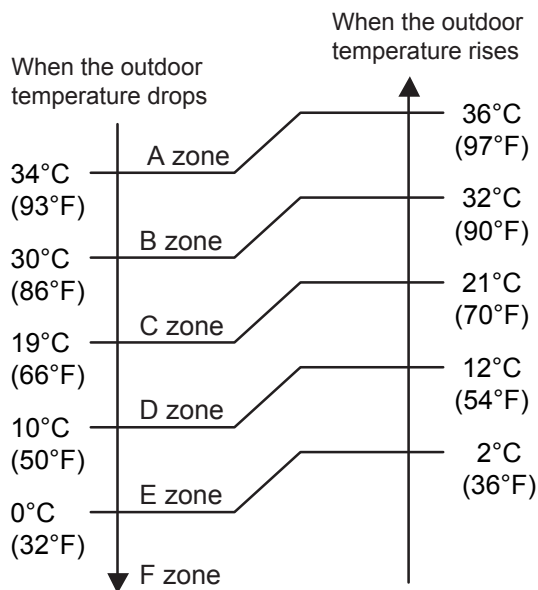

(Table 2 : Limit of maximum speed based on outdoor temperature)

	Outdoor temp. zone	Indoor fan mode			
		Hi	Me	Lo	Quiet
ASU09RL2	A zone	80rps	49rps	42rps	32rps
	B zone	80rps	49rps	42rps	32rps
	C zone	80rps	49rps	42rps	32rps
	D zone	49rps	44rps	40rps	29rps
	E zone	49rps	44rps	40rps	29rps
	F zone	49rps	44rps	40rps	29rps
ASU12RL2	A zone	96rps	61rps	51rps	33rps
	B zone	96rps	61rps	51rps	33rps
	C zone	96rps	61rps	51rps	33rps
	D zone	73rps	57rps	45rps	33rps
	E zone	73rps	57rps	45rps	33rps
	F zone	73rps	57rps	45rps	33rps

2. HEATING OPERATION

A sensor (room temperature thermistor) built in the indoor unit body will usually perceive difference or variation between a set temperature and present room temperature, and controls the operation frequency of the compressor.

- * If the room temperature is lower by 3°C (6°F) than a set temperature, the compressor operation frequency will attain to maximum performance.
- * If the room temperature is some degrees higher than a set temperature, the compressor will be stopped.
- * When the room temperature is between +2.5°C (+5°F) to -3°C (-6°F) of the setting temperature, the compressor frequency is controlled within the range shown in Table 3. However, the maximum frequency is limited shown in Table 4 based on the fan mode.

(Table 3 : Compressor frequency range)

	Minimum frequency	Maximum frequency
AOU09RL2	18rps	80rps
AOU12RL2		120rps

(Table 4 : Limit of maximum speed based on outdoor temperature)

	Indoor fan mode				
	Hi	Me	Lo	Quiet	Auto
AOU09RL2	80rps				
AOU12RL2	120rps				

3. DRY OPERATION

The compressor frequency shall change according to the temperature, set temperature, and room temperature variation which the room temperature sensor of the indoor unit body has detected as shown in the Table 5.

However, after the compressor is driven, the indoor unit shall run at operation frequency of (09 : 52 rps, 12 : 61 rps) for 60 seconds.

(Table 5 : Compressor frequency in Dry mode)

		Operating frequency			Operating frequency
AO09RL2	X zone	30rps	AO12RL2	X zone	33rps
	J zone	28rps		J zone	25rps
	Y zone	0rps		Y zone	0rps

(Fig.2 : Compressor control based on room temperature)

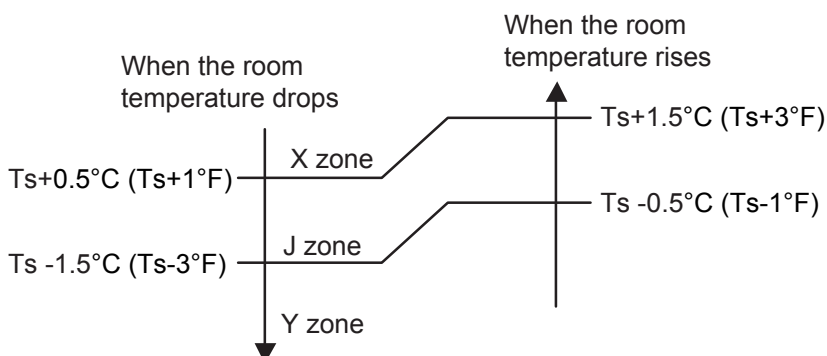

4. AUTO CHANGEOVER OPERATION

When the air conditioner is set to the AUTO mode by remote control, operation starts in the optimum mode from among the Heating, Cooling, Dry and Monitoring modes. During operation, the optimum mode is automatically switched in accordance with temperature changes. The temperature can be set between 18°C (64°F) and 30°C (88°F) in 1°C (2°F) steps.

(Fig. 3 : Operation flow chart in Auto changeover)

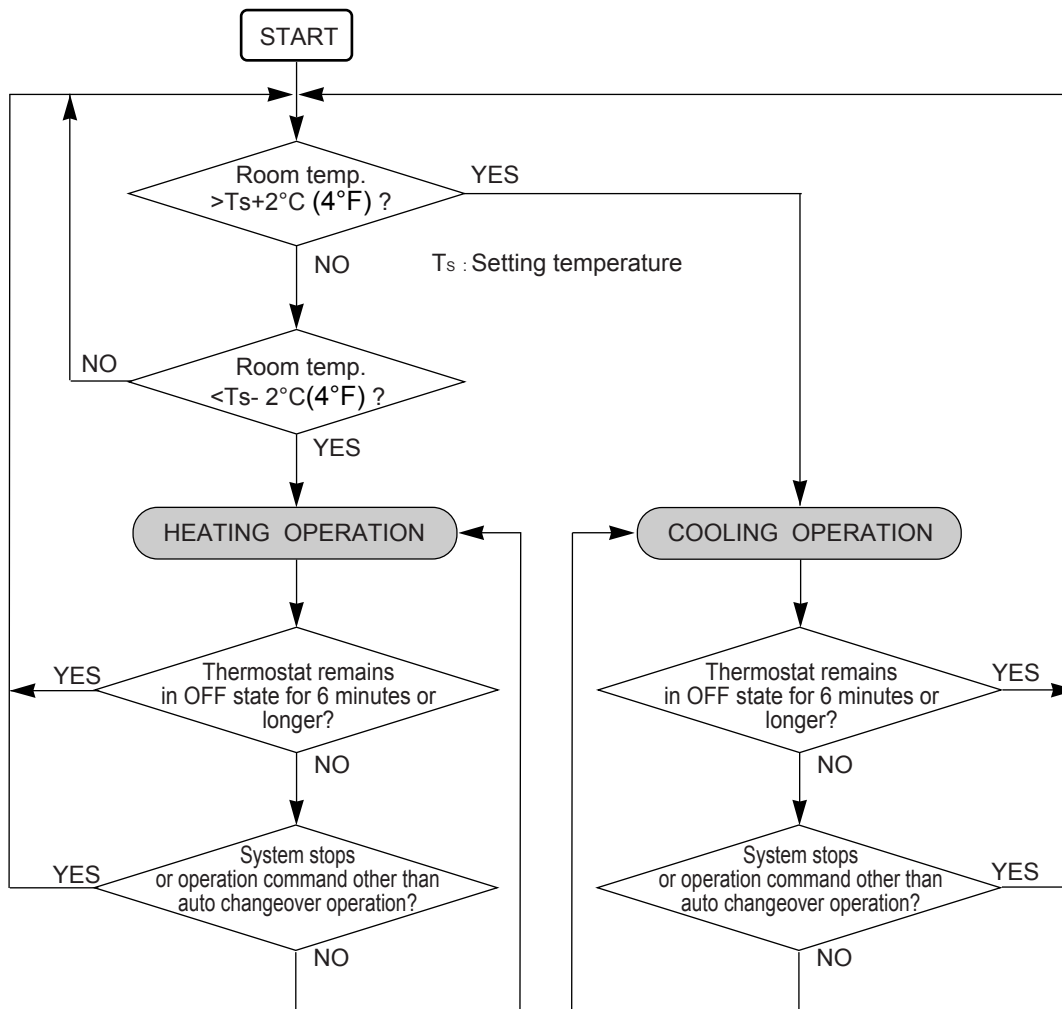

5. INDOOR FAN CONTROL

1. Fan speed

(Table 6 : Indoor fan speed)

Operation mode	Air flow mode	Speed (rpm)	
		ASU09RL2	ASU12RL2
Heating	Powerful	1420	1420
	Hi	1360	1360
	Me+	1290	1290
	Me	1120	1120
	Lo	900	900
	Quiet	700	700
	Cool air prevention	600	600
Cooling/ Fan	S-Lo	480	480
	Powerful	1400	1400
	Hi	1320	1320
	Me	1120	1120
	Lo	840	860
	Quiet	700	700
Dry	* Soft Quiet	600	600
		X zone: 700 J zone: 600	X zone: 700 J zone: 600

*Note, during Economy operation and operation mode is Fan, air flow is 1 step downs.
(Hi > Me, Me > Lo, Lo > Quiet, Quiet > Soft Quiet)

2. FAN OPERATION

The airflow can be switched in 5 steps such as Auto, Quiet, Lo, Me, Hi, while the indoor fan only runs. When fan mode is set at [Auto], it operates on [Me] fan Speed.

3. COOLING OPERATION

Switch the airflow [Auto], and the indoor fan motor will run according to a room temperature, as shown in Fig4. On the other hand, if switched in [Hi]~[Quiet], the indoor motor will run at a constant airflow of [Cool] operation modes Quiet, Lo, Me, Hi, as shown in Table 6.

(Fig.4 : Airflow change - over (Cooling : Auto))

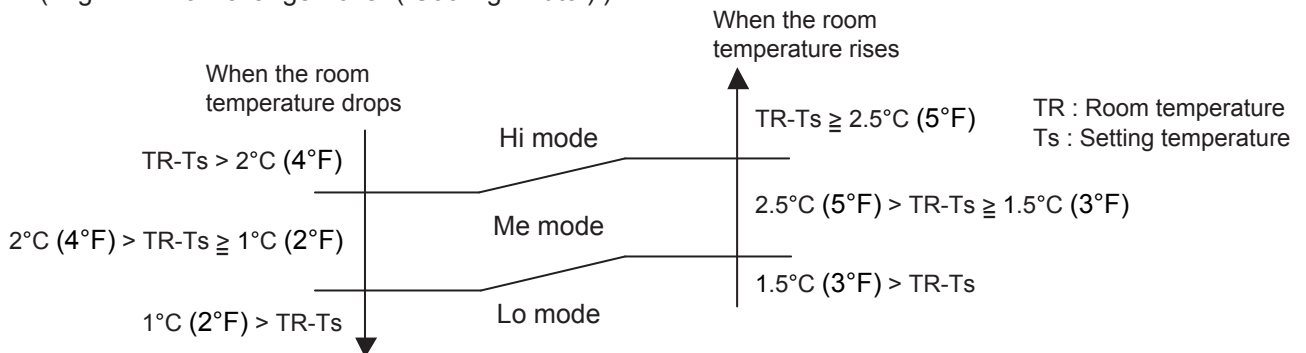

4. DRY OPERATION

Refer to the Table 6.

During the dry mode operation, the fan speed setting can not be changed.

5. HEATING OPERATION

Switch the airflow [Auto], and the indoor fan motor will run according to a room temperature, as shown in Fig. 5. On the other hand, if switched in [Hi] [Quiet], the indoor motor will run at a constant airflow of [Heat] operation modes Quiet, Lo, Me, High, as shown in Table 6.

(Fig.5 : Airflow change - over (Heating : Auto))

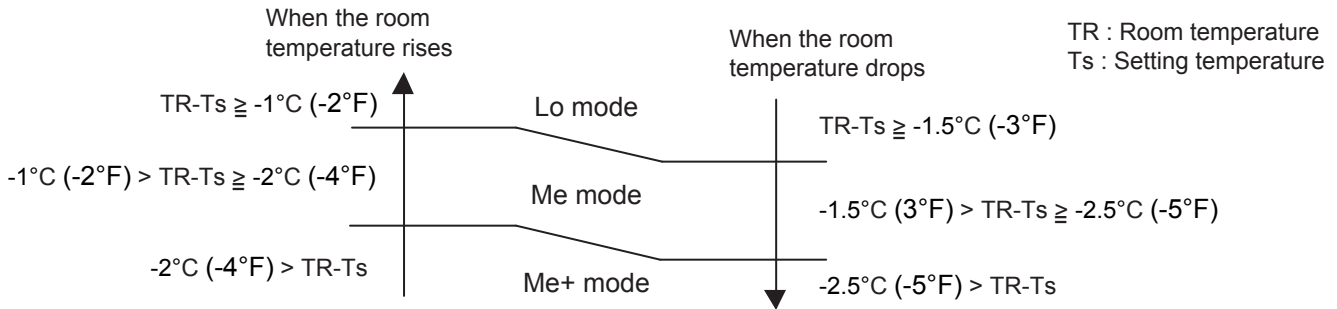

6. COOL AIR PREVENTION CONTROL (Heating mode)

The maximum value of the indoor fan speed is set as shown in Fig.6 based on the detected temperature by the indoor heat-exchanger sensor on heating mode.

(Fig.6 : Cool air prevention control)

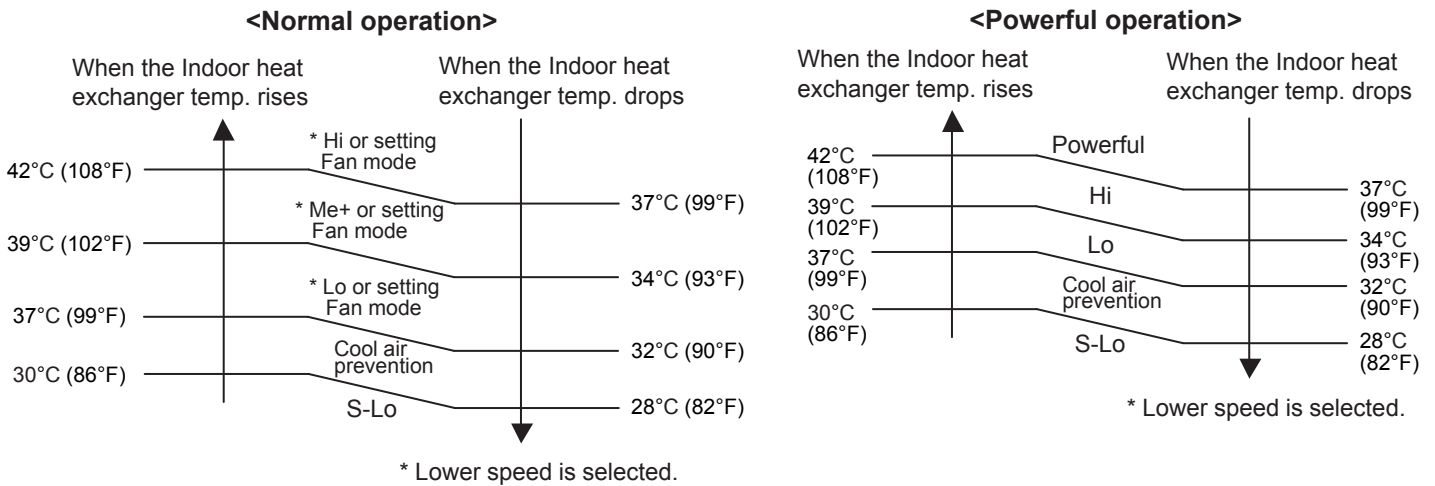

7. MOISTURE RETURN PREVENTION CONTROL (Cooling mode & Dry mode)

Switch the airflow [Auto] at cooling mode, and the indoor fan motor will run as shown in Fig.7.

(Fig.7 : Indoor fan control)

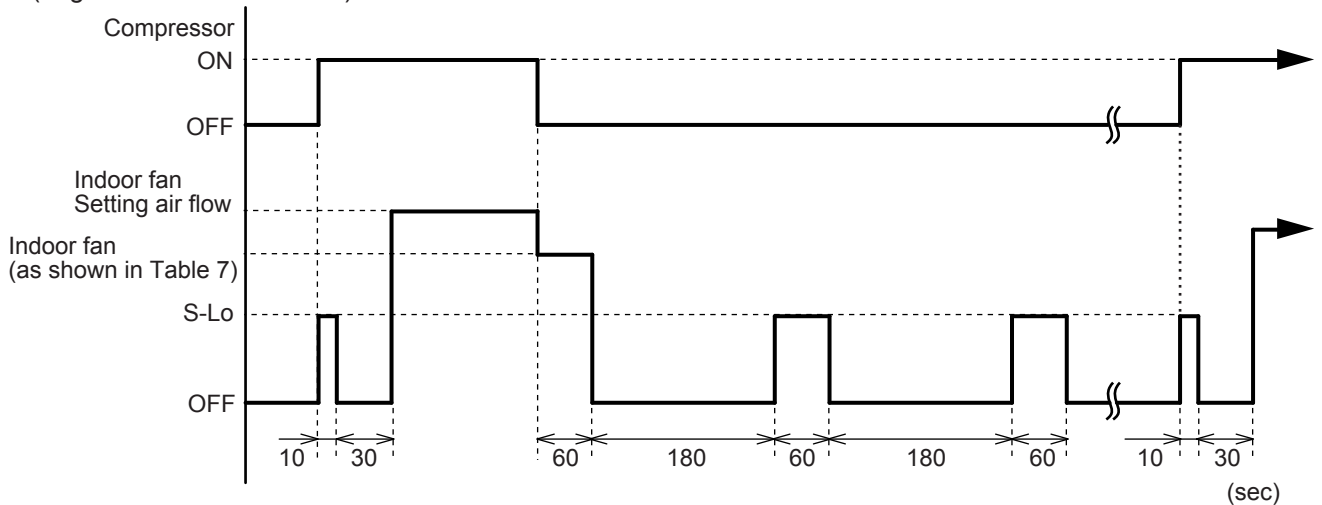

(Table 7 : Indoor fan speed)

	Dry			Cooling
	X zone	J zone	Y zone	
ASU09/12RL2	700rpm	600rpm	0⇔480rpm	700rpm

6. OUTDOOR FAN CONTROL

1. Outdoor Fan Motor

Following table shows the type of the outdoor fan motor. The control method is different between AC motor and DC motor.

(Table 8 : Type of Motor)

	AC motor	DC motor
AOU09RL2 AOU12RL2		○

2. Fan Speed

(Table 9 : Outdoor fan speed)

	Zone ※	Cooling	Heating	Dry
AOU09RL2	Y	730 / 650 / 470	900 / 650 / 470	730 / 470
	Z	730 / 470 / 360		
	F	360 / 150		
	G	210 / 150		
AOU12RL2	Y	860 / 760 / 470	900 / 760 / 680 / 470	760 / 470
	Z	860 / 470 / 380		
	F	380 / 280		
	G	280 / 200		

※ Refer to Fig.8

(Fig.8 : Outside air temperature zone selection)

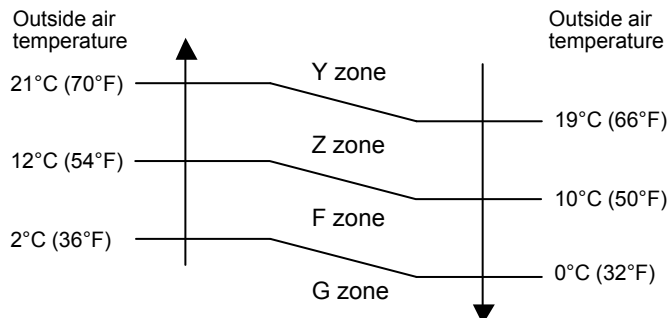

*The outdoor fan speed mentioned above depends on the compressor frequency. (When the compressor frequency increases, the outdoor fan speed also changes to the higher speed. When the compressor frequency decreases, the outdoor fan speed also changes to the lower speed.)

*After the defrost control is operated on the heating mode, the fan speed keeps at the higher speed as table 10 without relating to the compressor frequency.

(Table 10 : Outdoor fan speed after the defrost)

AOU09RL2 AOU12RL2	900 rpm
----------------------	---------

7. LOUVER CONTROL

1. VERTICAL LOUVER CONTROL

(Function Range)

Each time the button is pressed, the air direction range will change as follow:

① ↔ ② ↔ ③ ↔ ④ ↔ ⑤ ↔ ⑥ ↔ ⑦

Types of Air flow Direction Setting:

①, ②, ③, ④ : During Cooling/Dry modes

④, ⑤, ⑥, ⑦ : During Heating

The Remote Controller's display does not change.

Fig.8 : Air Direction Range

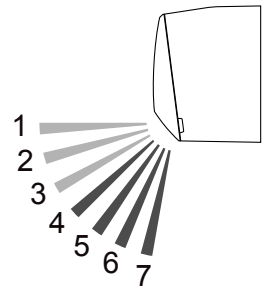

- Use the air direction adjustments within the ranges shown above.
- The vertical airflow direction is set automatically as shown, in accordance with the type of operation selected.
 - Cooling / Dry mode : Horizontal flow ①
 - Heating mode : Downward flow ⑦
- If you set the angle to position ⑤ ~ ⑦ for more than 30 minutes in Cooling or Dry mode, they automatically return to position ④ .
In Cooling or Dry mode, if the angle is set to position ⑤ ~ ⑦ for many hours, condensation may be formed, and the drips may wet your property.

2. ADJUST THE RIGHT-LEFT LOUVERS

- Move the Right-Left louvers to adjust air flow in the direction you prefer.

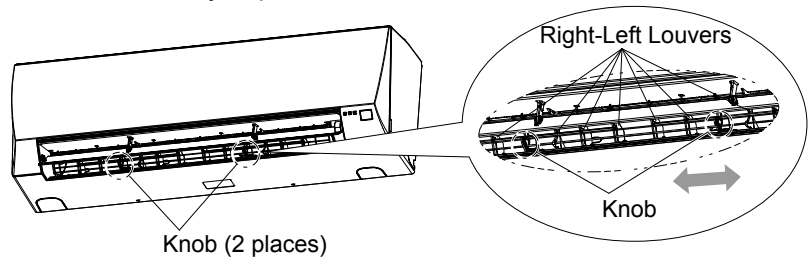

3. SWING OPERATION

To select Vertical Airflow Swing Operation

When the swing signal is received from the remote controller, the vertical louver starts to swing.

(Table10 : Swinging Range)

	Range
Cooling / Dry mode Fan mode (① ~ ④)	① ↔ ④
Heating mode Fan mode (⑤ ~ ⑦)	④ ↔ ⑦

- The SWING operation may stop temporarily when the air conditioner's fan is not operating, or when operating at very low speeds.

To select Horizontal Airflow Swing Operation

(No function)

8. COMPRESSOR CONTROL

1. OPEARTION FREQUENCY RANGE

The operation frequency of the compressor is different based on the operation mode as shown in the Table 11.

(Table 11 : Compressor frequency range)

	Cooling / Dry		Heating	
	Minimum	Maximum	Minimum	Maximum
AOU09RL2	18rps	80rps	18rps	120rps
AOU12RL2		96rps		

2. OPEARTION FREQUENCY CONTROL AT NORMAL START UP

The compressor frequency soon after the start-up is controlled as shown in the Fig.9.

(Fig.9 : Compressor control at start-up)

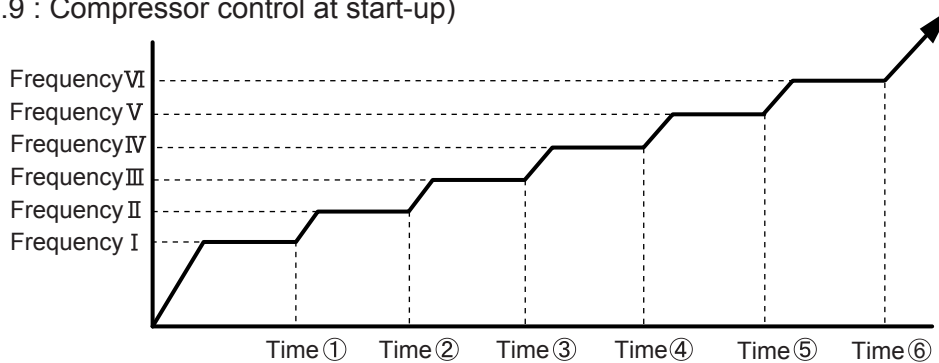

(Frequency)

	Frequency I	Frequency II	Frequency III	Frequency IV	Frequency V	Frequency VI
AOU09RL2	56rps	67rps	75rps	78rps	78rps	78rps
AOU12RL2	56rps	74rps	87rps	97rps	108rps	119rps

(Time)

	Time ①	Time ②	Time ③	Time ④	Time ⑤	Time ⑥
AOU09RL2	80sec	140sec	200sec	380sec	440sec	440sec
AOU12RL2	60sec	100sec	140sec	200sec	350sec	410sec

3. LIMITATION OF COMPRESSOR FREQUENCY BY OUTDOOR TEMPERATURE

The minimum compressor frequency is limited by outdoor temperature as shown in the Table12.

(Table12 : Limitation of Compressor Frequency)

[Cooling/ Dry]

	10°C (50°F)		14°C (59°F)		40°C (104°F)	
	Under	Over	Under	Over	Under	Over
AOU09RL2	35rps	23rps	-----		30rps	
AOU12RL2	45rps	27rps				

[Heating]

	- 3°C (26°F)		7°C (45°F)		14°C (59°F)		40°C (104°F)	
	Under	Over	Under	Over	Under	Over	Under	Over
AOU09RL2	34rps	22rps	27rps		-----		30rps	
AOU12RL2	36rps	27rps	27rps					

9. TIMER OPEARTION CONTROL

9-1 WIRELESS REMOTE CONTROLLER

The Table 13 shows the available timer setting based on the product model.

(Table 13 : Timer Setting)

	ON TIMER / OFF TIMER	PROGRAM TIMER	SLEEP TIMER
ASU09RL2 ASU12RL2	○	○	○

1. OPEARTION FREQUENCY RANGE

- OFF timer : When the clock reaches the set time, the air conditioner will be turned off.

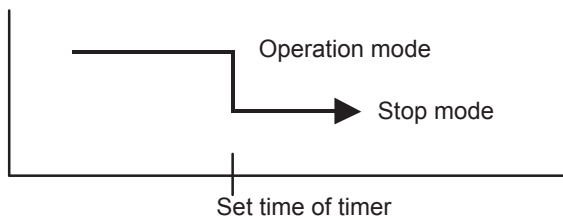

- ON timer : When the clock reaches the set time, the air conditioner will be turned on.

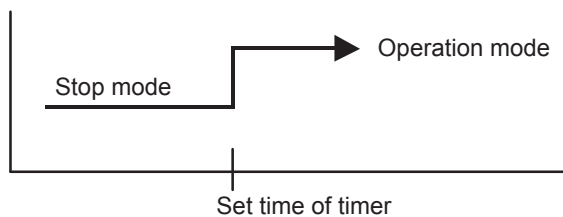

2. PROGRAM TIMER

- The program timer allows the OFF timer and ON timer to be used in combination one time.

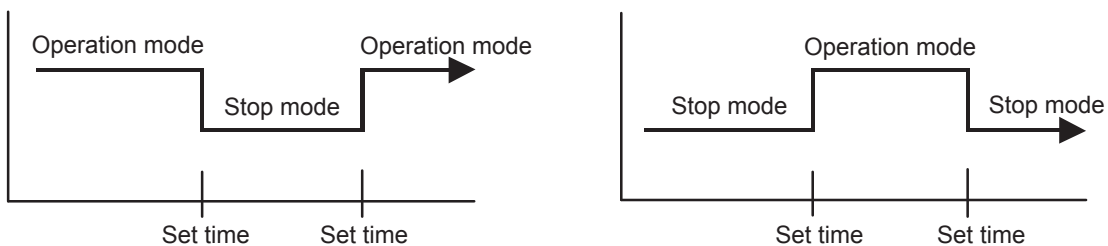

- Operation will start from the timer setting (either OFF timer or ON timer) whichever is closest to the clock's current timer setting.
The order of operations is indicated by the arrow in the remote control unit's display.
- SLEEP timer operation cannot be combined with ON timer operation.

3. SLEEP TIMER

If the sleep is set, the room temperature is monitored and the operation is stopped automatically. If the operation mode or the set temperature is change after the sleep timer is set, the operation is continued according to the changed setting of the sleep timer from that time ON.

In the cooling operation mode

When the sleep timer is set, the setting temperature is increased 1°C (2°F). It increases the setting temperature another 1°C (2°F) after 1 hour. After that, the setting temperature is not changed and the operation is stopped at the time of timer setting.

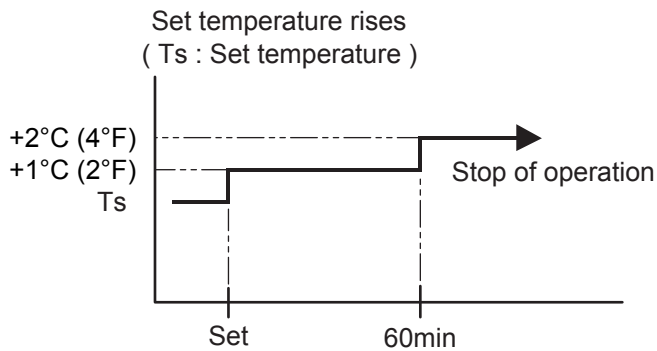

In the heating operation mode

When the sleep timer is set, the setting temperature is decreased 1°C (2°F). It decreases the setting temperature another 1°C (2°F) every 30 minutes. Upon lowering 4°C (8°F), the setting temperature is not changed and the operation stops at the time of timer setting.

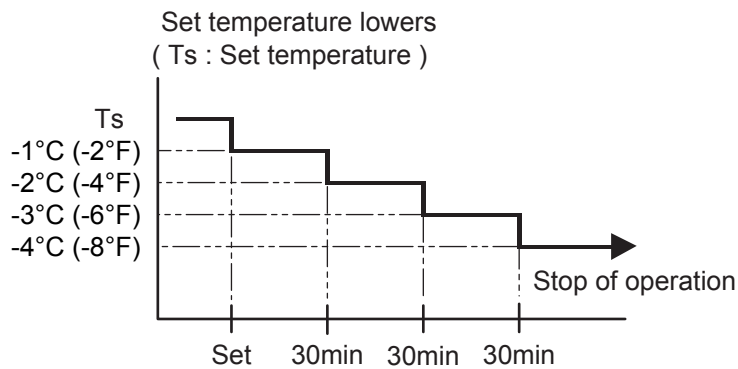

10. PREVENT TO RESTART FOR 3 MINUTES (3 MINUTES ST)

The compressor won't enter operation status for 2 minutes and 20 seconds after the compressor is stopped, even if any operation is given.

11. FOUR-WAY VALVE EXTENSION SELECT

At the time when the air conditioner is switched from the cooling mode to heating mode, the compressor is stopped, and the four-way valve is switched in 2 minutes and 20 seconds later after the compressor stopped.

12. AUTO RESTART

When the power was interrupted by a power failure, etc. during operation, the operation contents at that time are memorized and when power is recovered, operation is automatically started with the memorized operation contents.

When the power is interrupted and recovered during timer operation, since the timer operation time is shifted by the time the power was interrupted, an alarm is given by blinking (7 sec ON/2 sec OFF) the indoor unit body Timer lamp.

[Operation contents memorized when the power is interrupted]

- Operation mode
- Set temperature
- Set air flow
- Timer mode and set time
- Set air flow Direction
- Swing
- ECONOMY operation

13. MANUAL AUTO OPERATION (Indoor unit body operation)

When the remote control is lost or battery power dissipated, this function will work without the remote control. When MANUAL AUTO button is set more than 3seconds and less than 10seconds, MANUAL AUTO OPERATION will be started as shown in Table14.

To stop operation, press the MANUAL AUTO button for 3seconds.

(Table14 : MANUAL AUTO OPERATION)

	Manual auto operation
OPERATION MODE	Auto changeover
FAN CONT. MODE	Auto
TIMER MODE	Continuous (No timer setting available)
SETTING TEMP.	24°C (75°F)
SETTING LOUVER	Standard
SWING	OFF
ECONOMY	OFF

Press and hold MANUAL AUTO button for 3 ~ 10seconds

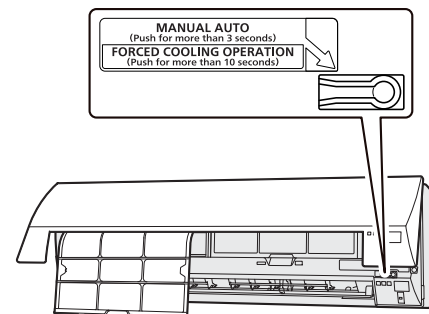

14. FORCED COOLING OPERATION (TEST OPERATION)

When FORCED COOLING OPERATION is set, the operation is controlled as shown in Table15.

(Table15 : FORCED COOLING OPERATION)

	Forced cooling operation
OPERATION MODE	Cooling
FAN CONT. MODE	Hi
TIMER MODE	-
SETTING TEMP.	Room Temp is not controlled
SETTING LOUVER	Horizontal (It is changed follow as setting of remote controller)
SWING	OFF
ECONOMY	-

- Forced cooling operation is started when press MANUAL AUTO button for 10 seconds or more.
- During the forced cooling operation, it operates regardless of room temperature sensor.
- Operation lamp and Timer lamp blink at the same time during the forced cooling operation.
They blink for 1 second ON and 1 second OFF on both Operation lamp and Timer lamp (same as test operation).
- Forced cooling operation is released after 60 minutes of starting operation or pressing MANUAL AUTO button for 3 seconds or pressing START/STOP button on the remote controller.

15. COMPRESSOR PREHEATING

When the outdoor heat exchanger temperature is lower than 5°C and the all operation has been stopped for 30 minutes, power is applied to the compressor and the compressor is heated. (By heating the compressor, warm air is quickly discharged when operation is started.)
When operation was started, and when the outdoor temperature rises to 7°C (44.6°F) or greater, preheating is ended.

16. ECONOMY OPERATION

The ECONOMY operation functions by pressing ECONOMY button on the remote controller. At the maximum output, ECONOMY Operation is approximately 70% of normal air conditioner operation for cooling and heating.
The ECONOMY operation is almost the same operation as below settings.

(Table 16)

Mode	Cooling/ Dry	Heating
Target temperature	Setting temp.+1°C (2°F)	Setting temp.-1°C (-2°F)

17. POWERFUL OPERATION

The POWERFUL OPERATION functions by pressing POWERFUL button on the remote controller. The indoor unit & outdoor unit will operate at maximum power as shown in Table17.

(Table17)

	Powerful operation
COMPRESSOR FREQUENCY	Maximum
FAN CONT. MODE	Powerful
SETTING LOUVER	Cooling/ Dry : 3, Heating : 5

Release Condition is as follows.

[Cooling / Dry]

- Room temperature \leq Setting temperature - 1.5°C (-3°F) or Operation time has passed 20 minutes.

[Heating]

- Room temperature \geq Setting temperature +1.5°C (+3°F) or Operation time has passed 20 minutes.

18. DEFROST OPERATION CONTROL

1. CONDITION OF STARTING THE DEFROST OPERATION

The defrost operation starts as shown in the following Table 18.

(Table 18 : Condition of starting Defrost Operation)

Normal defrost	Compressor integrating operation time	
	Less than 25 minutes	More than 25 minutes
	Does not operate	Outdoor heat exchanger temp. $\leq -17^{\circ}\text{C}$ (1.4°F) (at outside air temp. $\geq -10^{\circ}\text{C}$ (14°F)) ----- Outdoor heat exchanger temp. \leq Outside air temp. $- 7^{\circ}\text{C}$ (-44.6°F) or Outdoor heat exchanger temp. $\leq - 20^{\circ}\text{C}$ (-13°F) (at outside air temp. $< -10^{\circ}\text{C}$ (14°F))

Integrating defrost	Compressor integrating operation time		
	More than 240 minutes (For continuous operation)	More than 213 minutes (For continuous operation)	Less than 10 minutes* (For intermittent operation)
	Outdoor heat exchanger temperature below -3°C (-6°F)	Outdoor heat exchanger temperature below -5°C (-10°F)	OFF count of the compressor 40 times

*If the compressor continuous operation time is less than 10 minutes, the OFF number of the compressor is counted.
If any defrost operated, the compressor OFF count is cleared.

2. CONDITION OF THE DEFROST OPERATION COMPLETION

Defrost operation is released when the conditions become as shown in Table 19.

(Table 19 : Defrost Release Condition)

Release Condition
Outdoor heat exchanger temperature sensor value is higher than $+16^{\circ}\text{C}$ (60.8°F) or Compressor operation time has passed 15 minutes.

3. Defrost Flow Chart

The defrosting shall proceed by the integrating operation time, outdoor temperature and outdoor heat exchanger temperature as follows.

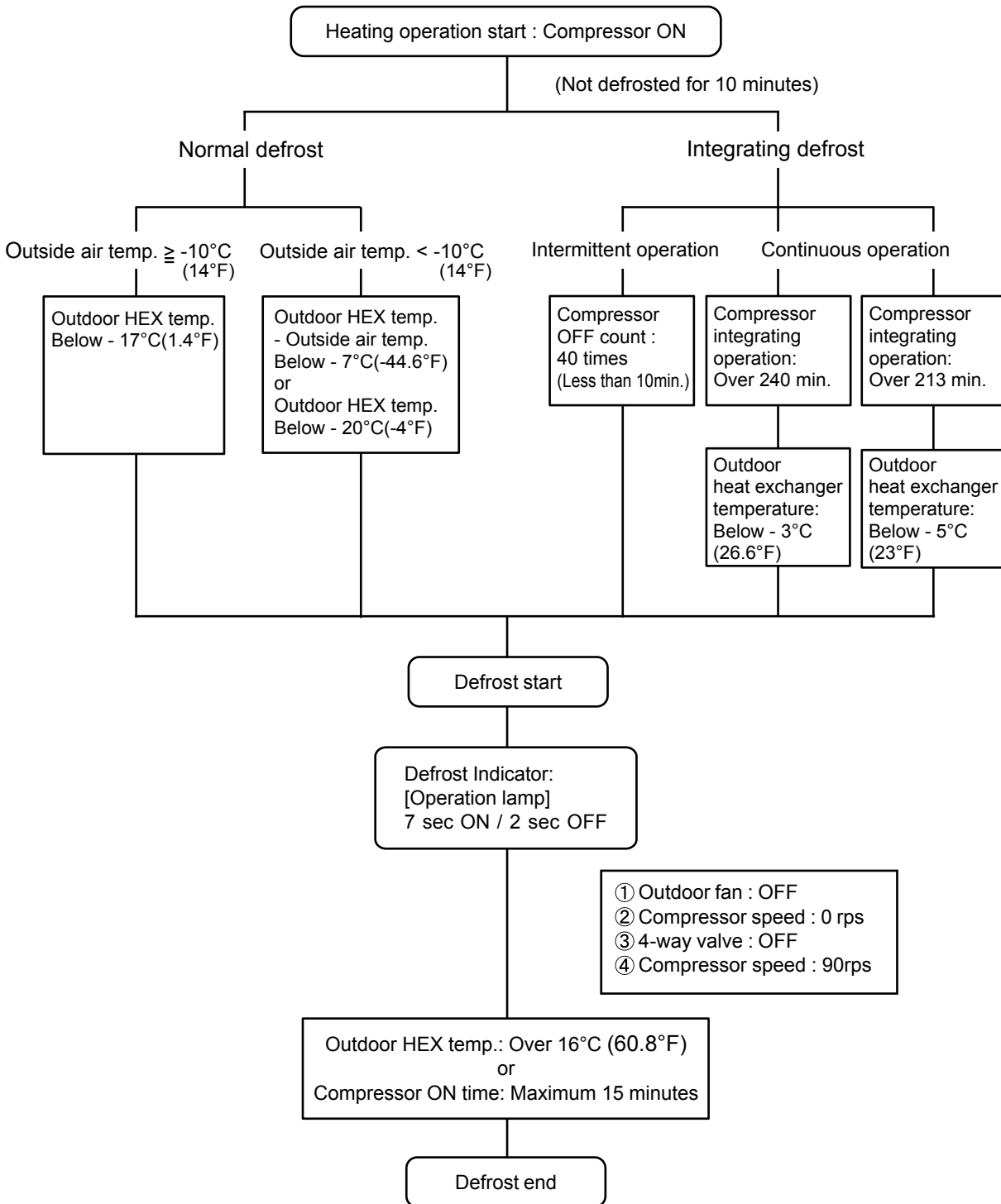

19. OFF DEFROST OPERATION CONTROL

When operation stops in the [Heating operation] mode, if frost is adhered to the outdoor unit heat exchanger, the defrost operation will proceed automatically. In this time, if indoor unit Operation lamp flashes slowly (7 sec ON / 2 sec OFF), the outdoor unit will allow the heat exchanger to defrost, and then stop.

1. OFF DEFROST OPERATION CONDITION

In heating operation, the outdoor heat exchanger temperature is less than -4°C (24.8°F), compressor continuous operation more than 10 minutes, and compressor operation integrating time lasts for more than 30 minutes.

2. OFF DEFROST END CONDITION

Release Condition
Outdoor heat exchanger temperature sensor value is higher than 16°C (60.8°F) or Compressor operation time has passed 15 minutes.

OFF Defrost Flow Chart

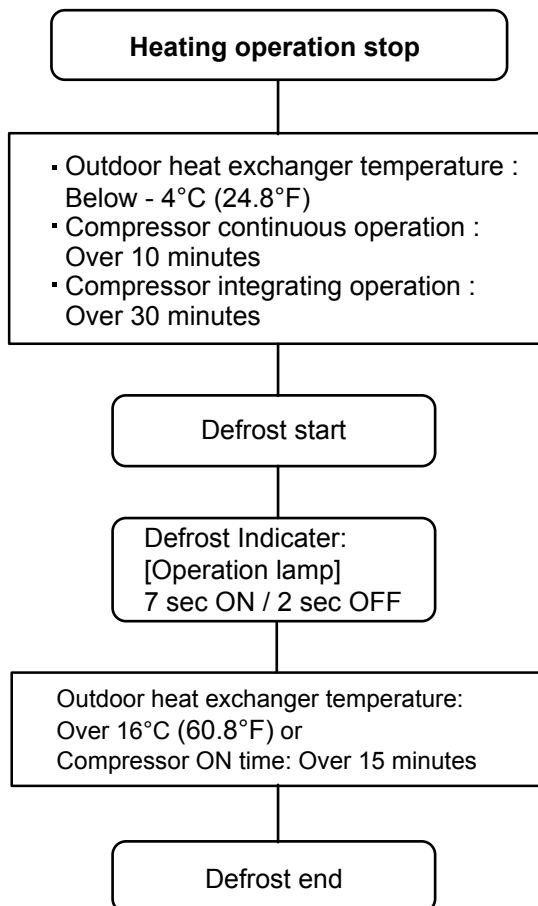

20. VARIOUS PROTECTIONS

1. DISCHARGE GAS TEMPERATURE OVERRISE PREVENION CONTROL

The discharge gas thermosensor (discharge thermistor : Outdoor side) will detect discharge gas temperature.

When the discharge temperature becomes higher than Temperature I , the compressor frequency is decreased 20rps, and it continues to decrease the frequency for 20rps every 120 seconds until the temperature becomes lower than Temperature I .

When the discharge temperature becomes lower than TemperatureII, the protection control of the compressor frequency will be released.

When the discharge temperature becomes higher than Temperature III, the compressor is stopped and the indoor unit body Operation lamp and Timer lamp starts blinking.

(Table 20 : Discharge temperature over rise prevention control / Release temperature)

Temperature I	Temperature II	Temperature III
104°C (219.2°F)	101°C (213.8°F)	110°C (230°F)

2. CURRENT RELEASE CONTROL

The compressor frequency is controlled so that the outdoor unit input current does not exceed the current limit value that was set up with the outdoor temperature.

The compressor frequency returns to the designated frequency of the indoor unit at the time when the frequency becomes lower than the release value.

(Table 21 : Current release operation value / Release value)

[Heating]

AOU09RL2	
OT (Control / Release)	
	10.5A / 10.0A
17°C (62.6°F)	12.0A / 11.5A
12°C (53.6°F)	12.5A / 12.0A
5°C (41°F)	12.5A / 12.0A

OT : Outdoor Temperature

[Heating]

AOU12RL2	
OT (Control / Release)	
	11.0A / 10.5A
17°C (62.6°F)	12.0A / 11.5A
12°C (53.6°F)	14.0A / 13.5A
5°C (41°F)	14.5A / 13.5A

OT : Outdoor Temperature

[Cooling]

AOU09RL2	
OT (Control / Release)	
	8.0A / 7.5A
46°C (114.8°F)	9.0A / 8.5A
40°C (104°F)	12.0A / 11.5A

OT : Outdoor Temperature

[Cooling]

AOU12RL2	
OT (Control / Release)	
	9.0A / 8.5A
46°C (114.8°F)	10.0A / 9.5A
40°C (104°F)	12.0A / 11.5A

OT : Outdoor Temperature

3. ANTIFREEZING CONTROL (Cooling and Dry mode)

The compressor frequency is decrease on cooling & dry mode when the indoor heat exchanger temperature sensor detects the temperature lower than Temperature I. Then, the anti-freezing control is released when it becomes higher than Temperature II.

(Table 22 : Anti-freezing Protection Operation / Release Temperature)

Outdoor temperature	Temperature I	Temperature II
Over than 10°C (50°F)*1 or 12°C (53.6°F) *2	4°C (39.2°F)	7°C (44.6°F)
Less than 10°C(50°F) *1 or 12°C (53.6°F) *2		13°C (55.4°F)

*1. When the temperature rises.

*2. When the temperature drops.

4. COOLING PRESSURE OVERRISE PROTECTION

When the outdoor unit heat exchange sensor temperature rises to 67°C (152.6°F) or greater, the compressor and the outdoor fan motor are stopped and trouble display is performed.

5. HIGH TEMPERATURE RELEASE CONTROL (HEATING MODE)

On heating mode, the compressor frequency is controlled as following based on the detection value of the indoor heat exchanger temperature sensor.

[Control System]

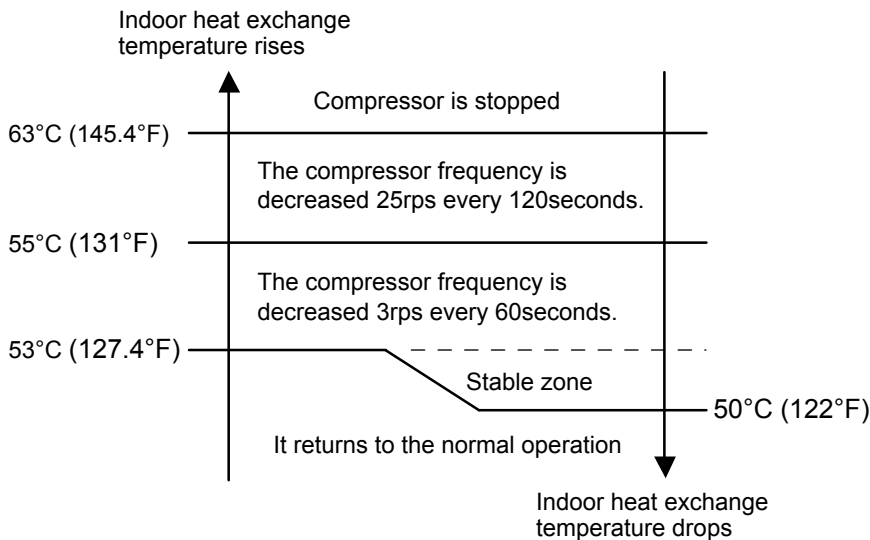

WALL MOUNTED type INVERTER

2 . TROUBLE SHOOTING

2. TROUBLESHOOTING

2-1 ERROR DISPLAY

Please refer the flashing pattern as follows.

Indoor Unit : ASU09/ 12RL2

The Operation, Timer and Economy lamps operate as follows according to the error contents.

Error Contents	Indoor Unit Display			Trouble shooting
	Operation [■] (Green)	Timer [☺] (Orange)	Economy [☺] (Green)	
Serial communication error	1 times	1 times	Continuous	1
Indoor unit PCB model information error	3 times	2 times	Continuous	2
Manual auto switch error	3 times	5 times	Continuous	3
Room temp. sensor error	4 times	1 times	Continuous	4
Indoor unit Heat Ex. middle temp. sensor error	4 times	2 times	Continuous	5
Indoor unit fan motor error	5 times	1 times	Continuous	6
Outdoor unit main PCB model information error or communication error	6 times	2 times	Continuous	7
PFC circuit error	6 times	4 times	Continuous	8
Trip terminal L error	6 times	5 times	Continuous	9
Discharge temp. sensor error	7 times	1 times	Continuous	10
Outdoor unit Heat Ex. liquid temp. sensor error	7 times	3 times	Continuous	11
Outdoor temp. sensor error	7 times	4 times	Continuous	12
Current sensor error	8 times	4 times	Continuous	13
Trip detection	9 times	4 times	Continuous	14
Compressor rotor position detection error	9 times	5 times	Continuous	15
Outdoor unit fan motor error	9 times	7 times	Continuous	16
4-way valve error	9 times	9 times	Continuous	17
Discharge temp. error	10 times	1 times	Continuous	18

2-2 TROUBLE SHOOTING WITH ERROR CODE

Trouble shooting 1-1
OUTDOOR UNIT Error Method:
Serial communication error
(Serial Reverse Transfer Error)

Indicate or Display:

Refer to error code table.

Detective Actuators:

Outdoor unit Main PCB

Detective details:

When the indoor unit cannot receive the serial signal from Outdoor unit more than 2minutes after power ON, or the indoor unit cannot receive the serial signal more than 15seconds during normal operation.

Forecast of Cause:

1. Connection failure 2. External cause 3. Main PCB failure

Check Point 1-1 : Reset the power and operate

· Does Error indication show again?

NO

YES

Check Point 2 : Check Connection

· Check any loose or removed connection line of Indoor unit and Outdoor unit.
 >> **If there is an abnormal condition, correct it by referring to Installation Manual or Data & Technical Manual.**

Check Point 1-2: Check external cause such as noise

· Check the complete insulation of the grounding.
 · Check if there is any equipment that causes harmonic wave near the power cable (Neon light bulb or any electronic equipment which causes harmonic wave).

OK

Check Point 3 : Check the voltage of power supply

· Check the voltage of power supply
 >> **Check if AC103V (AC115V -10%) - 127V (AC115V +10%) appears at Outdoor Unit Terminal L - N.**

AC

OK

Check Point 4 : Check Serial Signal (Reverse Transfer Signal)

· Check Serial Signal (Reverse Transfer Signal)
 >> **Check if Indicated value swings between AC45V and AC135V at Outdoor Unit Terminal 1 - 3.**
 >> **If it is abnormal, replace Main PCB.**

AC

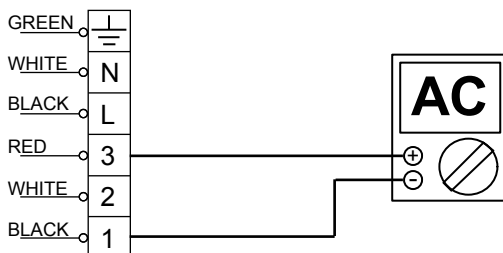

Trouble shooting 1-2 INDOOR UNIT Error Method: Serial communication error (Serial Forward Transfer Error)	Indicate or Display: Refer to error code table.
--	--

Detective Actuators: Indoor unit Controller PCB Indoor unit Fan motor	Detective details: When the outdoor unit cannot receive the serial signal from Indoor unit more than 10seconds.
--	---

Forecast of Cause:
1. Connection failure 2. External cause 3. Controller PCB failure 4. Indoor unit fan motor failure

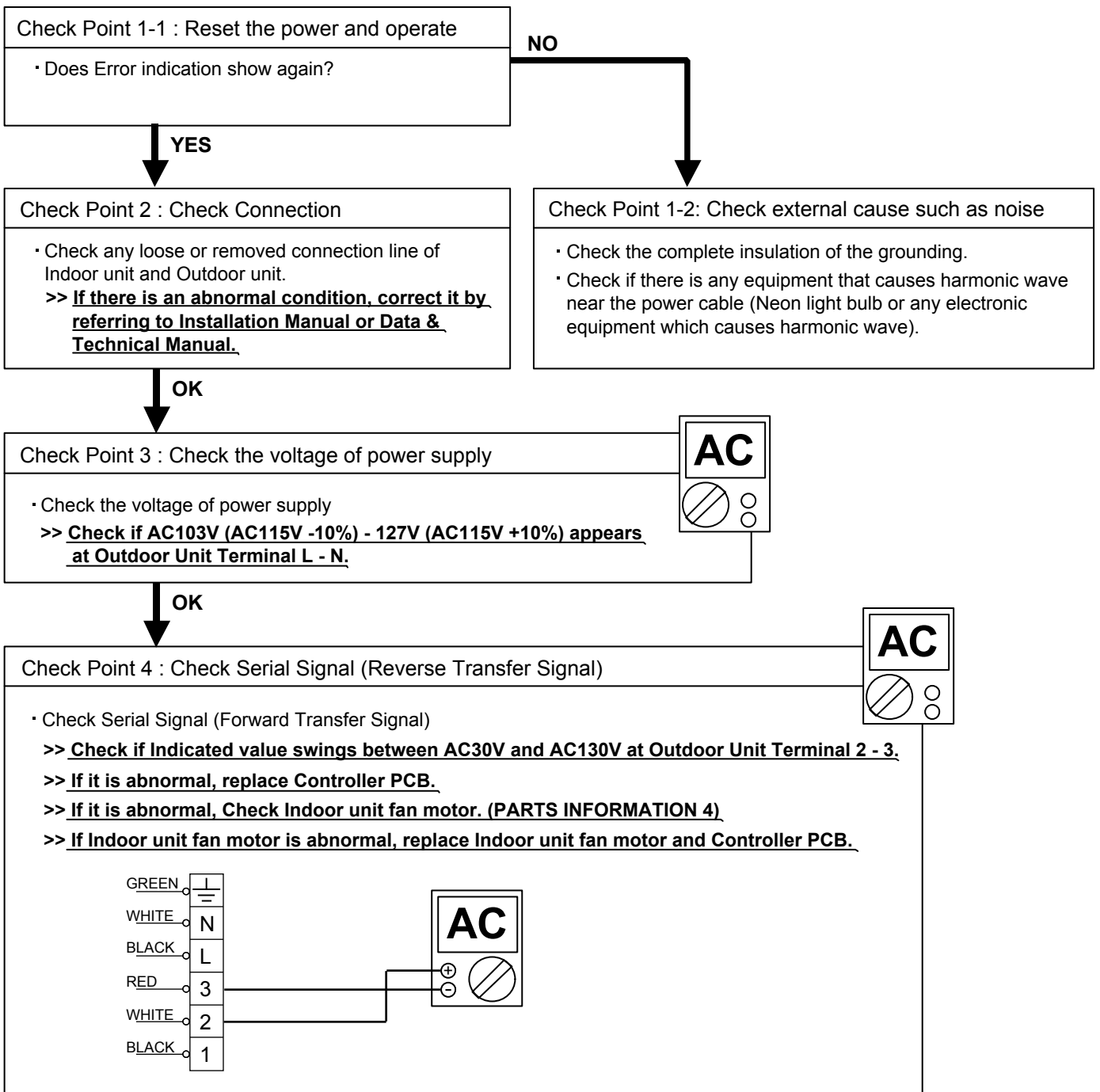

Trouble shooting 2 <u>INDOOR UNIT Error Method:</u> Indoor unit PCB model information error	<u>Indicate or Display:</u> Refer to error code table.
---	--

<u>Detective Actuators:</u> Indoor unit Controller PCB	<u>Detective details:</u> When power is on and there is some below case. 1. When model information of EEPROM is incorrect. 2. When the access to EEPROM failed.
--	---

<u>Forecast of Cause:</u> 1. External cause 2. Defective connection of electric components 3. Controller PCB failure
--

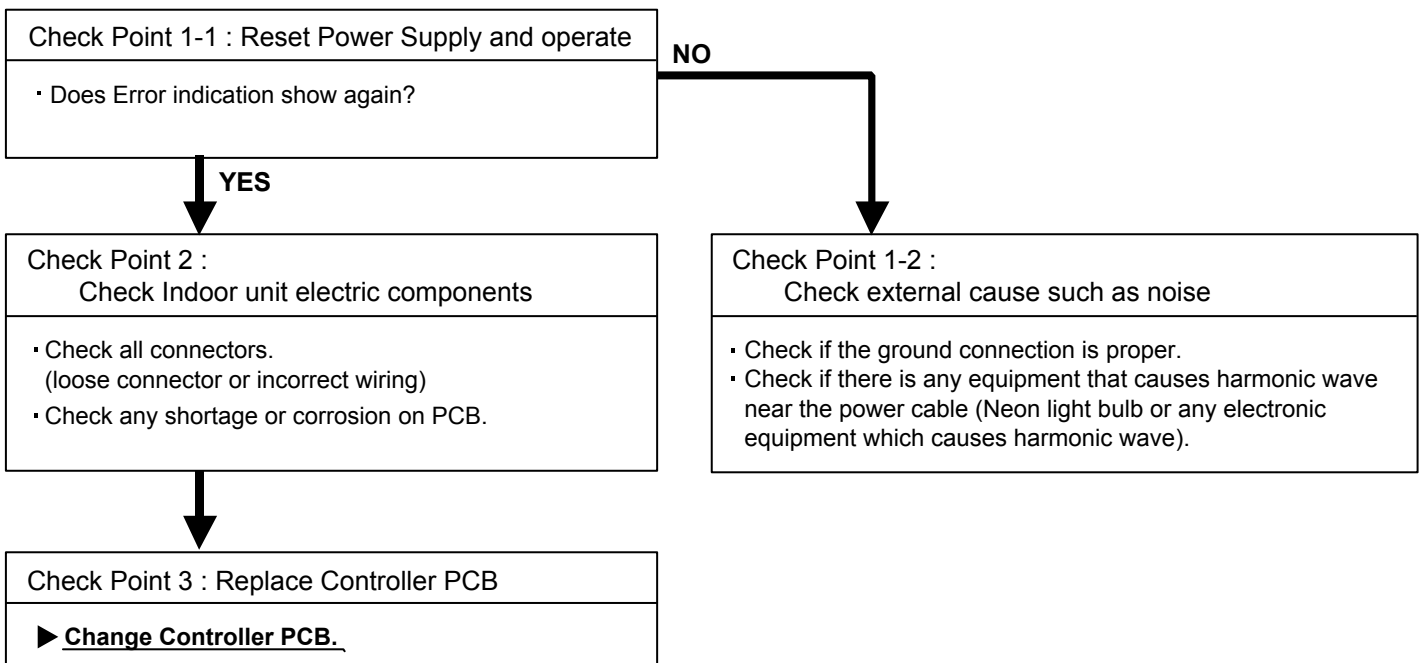

Note : EEPROM

EEPROM(Electronically Erasable and Programmable Read Only Memory) is a non-volatile memory which keeps memorized information even if power is turned off. It can change the contents electronically. To change the contents, it uses higher voltage than normal, and it can not change a partial contents. (Rewriting shall be done upon erasing the all contents.) There is a limit in a number of rewriting.

<p>Trouble shooting 3 <u>INDOOR UNIT Error Method:</u> Manual auto switch error</p>	<p><u>Indicate or Display:</u></p> <p>Refer to error code table.</p>
--	--

<p><u>Detective Actuators:</u></p> <p>Indoor unit Controller PCB Indicator PCB Manual auto switch</p>	<p><u>Detective details:</u></p> <p>When the Manual auto switch becomes ON for consecutive 60 or more seconds.</p>
--	---

<p><u>Forecast of Cause :</u></p> <p>1. Manual auto switch failure 2.Controller PCB and Indicator PCB failure</p>

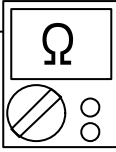
<p>Check Point 1 : Check the Manual auto switch</p> <ul style="list-style-type: none"> • Check if Manual auto switch is kept pressed. • Check ON/OFF switching operation by using a meter. <p>>><u>If Manual Auto Switch is disabled (on/off switching), replace it.</u></p>	
---	--



<p>Check Point 2 : Replace Controller PCB</p>
<p>▶ <u>If Check Point 1 do not improve the symptom, change Controller PCB and Indicator PCB.</u></p>

Trouble shooting 4 INDOOR UNIT Error Method: Room temp. sensor error	Indicate or Display: Refer to error code table.
---	--

Detective Actuators: Indoor unit Controller PCB Room temperature thermistor	Detective details: When Room temperature thermistor open or short-circuit is detected.
--	--

Forecast of Cause : 1. Connector connection failure 2. Thermistor failure 3. Controller PCB failure

Check Point 1 : Check connection of Connector
<ul style="list-style-type: none"> • Check if connector is removed. • Check erroneous connection. • Check if thermistor cable is open. <p>>>Upon correcting the removed connector or mis-wiring, reset the power.</p>



Check Point 2 : Remove connector and check Thermistor resistance value									
Thermistor Characteristics (Approx. value)									
Temperature	-10°C (14°F)	-5°C (23°F)	0°C (32°F)	5°C (41°F)	10°C (50°F)	15°C (59°F)	20°C (68°F)	25°C (77°F)	
Resistance Value (kΩ)	55.46	42.36	32.67	25.39	19.91	15.71	12.5	10.0	
Temperature	30°C (86°F)	35°C (95°F)	40°C (104°F)	45°C (113°F)					
Resistance Value (kΩ)	8.051	6.52	5.316	4.354					
► If Thermistor is either open or shorted, replace it and reset the power.									



Check Point 3 : Check voltage of Controller PCB (DC5.0V)																			
Make sure circuit diagram of indoor unit and check terminal voltage at Thermistor (DC5.0V)																			
<table border="1" style="width: 100%;"> <tr> <td style="text-align: center;">THERMISTOR (PIPE)</td> <td></td> <td></td> </tr> <tr> <td style="text-align: center;"></td> <td style="text-align: center;">BLACK</td> <td style="text-align: center;">1 1</td> </tr> <tr> <td style="text-align: center;"></td> <td style="text-align: center;">BLACK</td> <td style="text-align: center;">2 2</td> </tr> <tr> <td style="text-align: center;"></td> <td style="text-align: center;">BLACK</td> <td style="text-align: center;">3 3</td> </tr> <tr> <td style="text-align: center;"></td> <td style="text-align: center;">BLACK</td> <td style="text-align: center;">4 4</td> </tr> <tr> <td style="text-align: center;">THERMISTOR (ROOM TEMP.)</td> <td></td> <td></td> </tr> </table>	THERMISTOR (PIPE)				BLACK	1 1		BLACK	2 2		BLACK	3 3		BLACK	4 4	THERMISTOR (ROOM TEMP.)			CN4
THERMISTOR (PIPE)																			
	BLACK	1 1																	
	BLACK	2 2																	
	BLACK	3 3																	
	BLACK	4 4																	
THERMISTOR (ROOM TEMP.)																			
► If the voltage does not appear, replace Controller PCB.																			

Trouble shooting 5 INDOOR UNIT Error Method: Indoor unit Heat Ex. middle temp. sensor error	Indicate or Display: Refer to error code table.
--	--

Detective Actuators: Indoor unit Controller PCB Heat Ex. temperature thermistor	Detective details: When Heat Ex. temperature thermistor open or short-circuit is detected.
--	--

Forecast of Cause : 1. Connector connection failure 2. Thermistor failure 3. Controller PCB failure

Check Point 1 : Check connection of Connector
<ul style="list-style-type: none"> • Check if connector is removed. • Check erroneous connection. • Check if thermistor cable is open. <p>>>Upon correcting the removed connector or mis-wiring, reset the power.</p>



Check Point 2 : Remove connector and check Thermistor resistance value							
Thermistor Characteristics (Approx. value)							
Temperature	-10°C (14°F)	-5°C (23°F)	0°C (32°F)	5°C (41°F)	10°C (50°F)	20°C (68°F)	
Resistance Value (kΩ)	295.1	223.3	170.7	131.4	102.1	62.9	
Temperature	30°C (86°F)	40°C (104°F)	50°C (122°F)	60°C (140°F)	63°C (144°F)		
Resistance Value (kΩ)	39.78	25.8	17.11	11.6	10.36		
<p>► If Thermistor is either open or shorted, replace it and reset the power.</p>							



Check Point 3 : Check voltage of Controller PCB (DC5.0V)		
Make sure circuit diagram of indoor unit and check terminal voltage at Thermistor (DC5.0V)		
<p>► If the voltage does not appear, replace Controller PCB.</p>		

<p>Trouble shooting 6 <u>INDOOR UNIT Error Method:</u> Indoor unit fan motor error</p>	<p><u>Indicate or Display:</u> Refer to error code table.</p>
---	--

<p><u>Detective Actuators:</u> Indoor unit Controller PCB Indoor unit Fan motor</p>	<p><u>Detective details:</u> When the condition that actual frequency of Indoor Fan is below 1/3 of target frequency is continued more than 56 seconds.</p>
--	---

<p><u>Forecast of Cause:</u> 1. Fan rotation failure 2. Fan motor winding open 3. Motor protection by surrounding temperature rise 4. Control PCB failure 5. Indoor unit fan motor failure</p>
--

<p>Check Point 1 : Check rotation of Fan</p>
<p>· Rotate the fan by hand when operation is off. (Check if fan is caught, dropped off or locked motor) >><u>If Fan or Bearing is abnormal, replace it.</u></p>



<p>Check Point 2 : Check ambient temp. around motor</p>
<p>· Check excessively high temperature around the motor. (If there is any surrounding equipment that causes heat) >><u>Upon the temperature coming down, restart operation.</u></p>



<p>Check Point 3 : Check Indoor unit fan motor</p>
<p>· Check Indoor unit fan motor. (PARTS INFORMATION 4) >><u>If Indoor unit fan motor is abnormal, replace Indoor unit fan motor.</u></p>



<p>Check Point 4 : Replace Controller PCB</p>
<p>► <u>If Check Point 1- 3 do not improve the symptom, replace Controller PCB.</u></p>

<p>Trouble shooting 7 <u>OUTDOOR UNIT Error Method:</u> Outdoor unit main PCB model information error or communication error</p>	<p><u>Indicate or Display:</u> Refer to error code table.</p>
---	--

<p><u>Detective Actuators:</u> Outdoor unit Main PCB</p>	<p><u>Detective details:</u> When model information of EEPROM is incorrect at power ON. If the above operation is repeated 3 times, the compressor stops permanently.</p>
--	---

<p><u>Forecast of Cause:</u> 1. External cause (Noise, temporary open, voltage drop) 2. Main PCB failure</p>
--

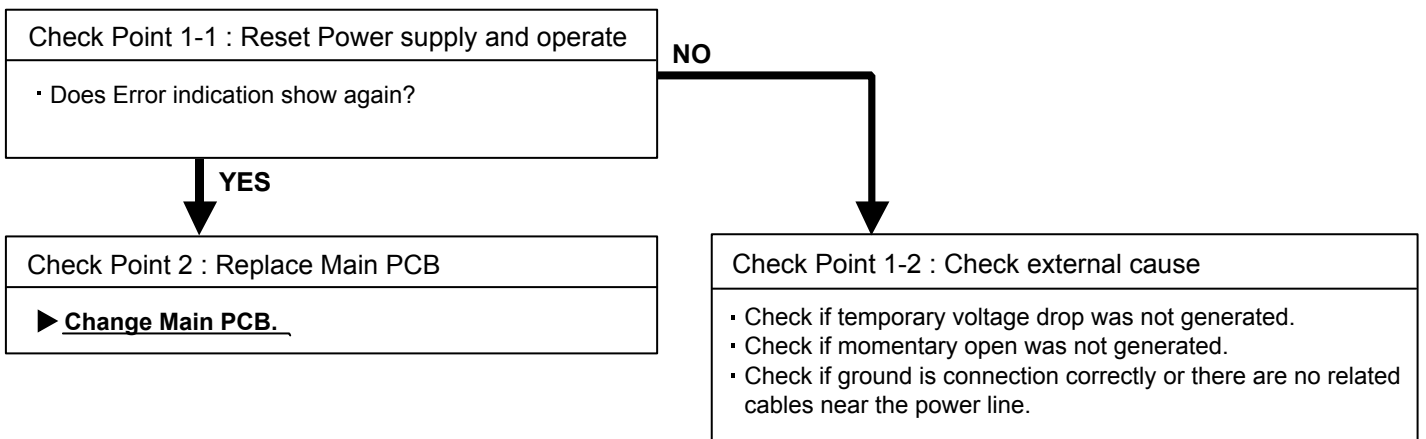

Trouble shooting 8 <u>OUTDOOR UNIT Error Method:</u> PFC circuit error	<u>Indicate or Display:</u> Refer to error code table.
---	---

<u>Detective Actuators:</u> Outdoor unit Main PCB	<u>Detective details:</u> When inverter output DC voltage is higher than 415V for over 3 seconds, the compressor stops. If the same operation is repeated 5 times, the compressor stops permanently.
---	---

<u>Forecast of Cause :</u> 1. External cause 2. Connector connection failure 3. Main PCB failure
--

Check Point 1 : Check external cause at Indoor and Outdoor (Voltage drop or Noise)
<ul style="list-style-type: none"> • Instant drop : Check if there is a large load electric apparatus in the same circuit. • Momentary power failure : Check if there is a defective contact or leak current in the power supply circuit. • Noise : Check if there is any equipment causing harmonic wave near electric line. (Neon bulb or electric equipment that may cause harmonic wave) Check the complete insulation of grounding.



Check Point 2 : Check connection of Connector
<ul style="list-style-type: none"> • Check if connector is removed. • Check erroneous connection. • Check if cable is open. <p>>><u>Upon correcting the removed connector or mis-wiring, reset the power.</u></p>



Check Point 3 : Replace Main PCB
<p>▶ <u>If Check Point 1, 2 do not improve the symptom, change Main PCB.</u></p>

Trouble shooting 9 <u>OUTDOOR UNIT Error Method:</u> Trip terminal L error	<u>Indicate or Display:</u> Refer to error code table.
---	---

<u>Detective Actuators:</u> Outdoor unit Main PCB	<u>Detective details:</u> When the signal from FO terminal of IPM in Main PCB is "L"(=0V) while the compressor stops.
---	---

<u>Forecast of Cause :</u> 1. Main PCB failure
--

Check Point 1 : Replace Main PCB
▶ <u>Change Main PCB.</u>

Trouble shooting 10 OUTDOOR UNIT Error Method: Discharge temp. sensor error	Indicate or Display: Refer to error code table.
--	--

Detective Actuators: Outdoor unit Main PCB Discharge pipe temperature thermistor	Detective details: When Discharge pipe temperature thermistor open or short-circuit is detected at power ON or while running the compressor.
---	--

Forecast of Cause :
1. Connector connection failure 2. Thermistor failure 3. Main PCB failure

Check Point 1 : Check connection of Connector

- Check if connector is removed.
- Check erroneous connection.
- Check if thermistor cable is open.

>>Upon correcting the removed connector or mis-wiring, reset the power.



Check Point 2 : Remove connector and check Thermistor resistance value

Ω

Thermistor Characteristics (Approx. value)

Temperature	-10°C (14°F)	-5°C (23°F)	0°C (32°F)	5°C (41°F)	10°C (50°F)	20°C (68°F)	30°C (86°F)
Resistance Value (k Ω)	286.3	218.6	168.6	130.9	102.5	64.22	41.33

Temperature	40°C (104°F)	50°C (122°F)	60°C (140°F)	70°C (158°F)	80°C (176°F)	90°C (194°F)	100°C (212°F)	110°C (230°F)	120°C (248°F)
Resistance Value (k Ω)	27.26	18.40	12.68	8.909	6.375	4.639	3.430	2.573	1.956

► If Thermistor is either open or shorted, replace it and reset the power.



Check Point 3 : Check voltage of Main PCB (DC5.0V)

DC

Make sure circuit diagram of outdoor unit and check terminal voltage at Thermistor (DC5.0V)

THERMISTOR (PIPE) BLACK 1 1
BLACK 2 2
BLACK 3 3
BLACK 4 4 CN71

THERMISTOR (DISCHARGE)

THERMISTOR (OUTDOOR) BLACK 1 1
BLACK 2 2
BLACK 3 3 CN70

► If the voltage does not appear, replace Main PCB.

Trouble shooting 11 OUTDOOR UNIT Error Method: Outdoor unit Heat Ex. liquid temp. sensor error	Indicate or Display: Refer to error code table.
---	--

Detective Actuators: Outdoor unit Main PCB Heat exchanger temperature thermistor	Detective details: When Heat exchanger temperature thermistor open or short-circuit is detected at power ON or while running the compressor.
---	--

Forecast of Cause :
1. Connector connection failure 2. Thermistor failure 3. Main PCB failure

Check Point 1 : Check connection of Connector

- Check if connector is removed.
- Check erroneous connection.
- Check if thermistor cable is open.

>>Upon correcting the removed connector or mis-wiring, reset the power.



Check Point 2 : Remove connector and check Thermistor resistance value Ω

Thermistor Characteristics (Approx. value)

Temperature	-10°C (14°F)	-5°C (23°F)	0°C (32°F)	5°C (41°F)	10°C (50°F)	20°C (68°F)	30°C (86°F)
Resistance Value (k Ω)	27.21	20.80	16.05	12.47	9.775	6.129	3.947

Temperature	40°C (104°F)	50°C (122°F)	60°C (140°F)	70°C (158°F)	80°C (176°F)
Resistance Value (k Ω)	2.606	1.759	1.213	0.8531	0.6115

► If Thermistor is either open or shorted, replace it and reset the power.



Check Point 3 : Check voltage of Main PCB (DC5.0V) DC

Make sure circuit diagram of outdoor unit and check terminal voltage at Thermistor (DC5.0V)

THERMISTOR (PIPE)
BLACK 1 1
BLACK 2 2
BLACK 3 3
BLACK 4 4 CN71

THERMISTOR (DISCHARGE)

THERMISTOR (OUTDOOR)
BLACK 1 1
BLACK 2 2
BLACK 3 3 CN70

► If the voltage does not appear, replace Main PCB.

Trouble shooting 12 OUTDOOR UNIT Error Method: Outdoor temp. sensor error	Indicate or Display: Refer to error code table.
--	--

Detective Actuators: Outdoor unit Main PCB Outdoor temperature thermistor	Detective details: When Outdoor temperature thermistor open or short-circuit is detected at power ON or while running the compressor.
--	---

Forecast of Cause :
1. Connector connection failure 2. Thermistor failure 3. Main PCB failure

Check Point 1 : Check connection of Connector

- Check if connector is removed.
- Check erroneous connection.
- Check if thermistor cable is open.

>>Upon correcting the removed connector or mis-wiring, reset the power.



Check Point 2 : Remove connector and check Thermistor resistance value Ω

Thermistor Characteristics (Approx. value)

Temperature	-20°C (4.0°F)	-15°C (5°F)	-10°C (14°F)	-5°C (23°F)	0°C (32°F)	5°C (41°F)	10°C (50°F)
Resistance Value (k Ω)	109.0	80.56	60.23	45.40	34.57	26.53	20.56

Temperature	15°C (59°F)	20°C (68°F)	25°C (77°F)	30°C (86°F)	35°C (95°F)	40°C (104°F)	45°C (113°F)	50°C (122°F)	55°C (131°F)
Resistance Value (k Ω)	16.04	12.26	10.00	7.978	6.408	5.184	4.216	3.451	2.841

► If Thermistor is either open or shorted, replace it and reset the power.



Check Point 3 : Check voltage of Main PCB (DC5.0V) DC

Make sure circuit diagram of outdoor unit and check terminal voltage at Thermistor (DC5.0V)

The diagram shows two thermistor components. The first is labeled 'THERMISTOR (PIPE)' and is connected to a 4-pin connector labeled 'CN71'. All four pins (1, 2, 3, 4) are labeled 'BLACK'. The second is labeled 'THERMISTOR (OUTDOOR)' and is connected to a 3-pin connector labeled 'CN70'. All three pins (1, 2, 3) are labeled 'BLACK'.

► If the voltage does not appear, replace Main PCB.

Trouble shooting 13 OUTDOOR UNIT Error Method: Current sensor error	Indicate or Display: Refer to error code table.
--	--

Detective Actuators: Outdoor unit Main PCB	Detective details: When Input Current Sensor has detected 0A, while Inverter Compressor is operating at higher than 56rps, after 1minute upon starting the Compressor. (Except during the defrost operation)
--	--

Forecast of Cause : 1. Defective connection of electric components 2. External cause 3. Main PCB failure
--

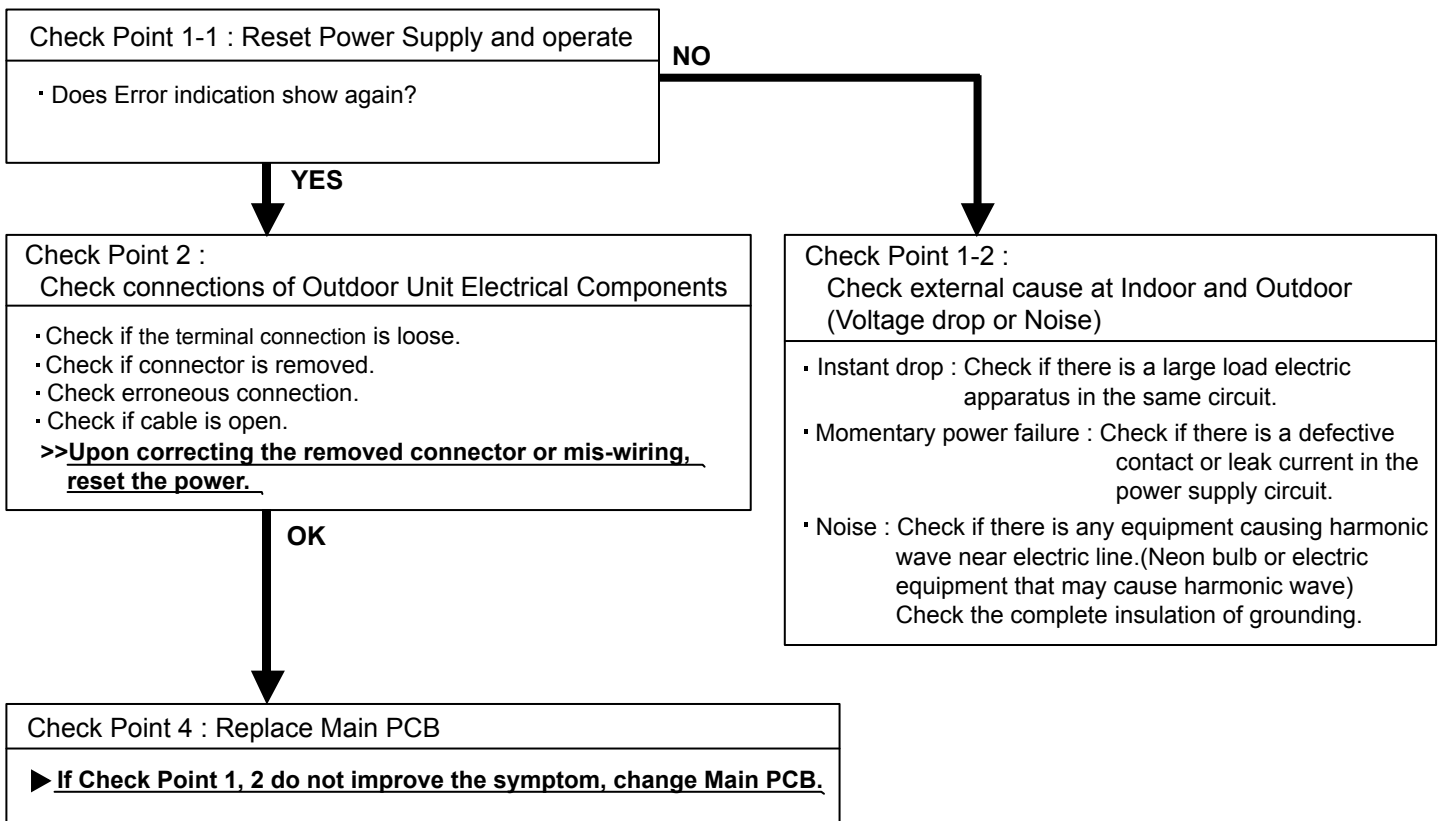

Trouble shooting 14 <u>OUTDOOR UNIT Error Method:</u> Trip detection	<u>Indicate or Display:</u> Refer to error code table.
---	---

<u>Detective Actuators:</u> Outdoor unit Main PCB Compressor	<u>Detective details:</u> ① When more than normal operating current to IPM in Main PCB flows, the compressor stops. ② After the compressor restarts, if the same operation is repeated within 40sec, the compressor stops again. ③ If ① and ② repeats 5 times, the compressor stops permanently.
---	--

<u>Forecast of Cause :</u> 1. Defective connection of electric components 2. Outdoor heat exchanger clogged 3. Compressor failure 4. Main PCB failure
--

Check Point 1 : Check connections of Outdoor unit electrical components
<ul style="list-style-type: none"> • Check if the terminal connection is loose. • Check if connector is removed. • Check erroneous connection. • Check if cable is open. >><u>Upon correcting the removed connector or mis-wiring, reset the power.</u>



Check Point 2 : Check Heat exchanger
<ul style="list-style-type: none"> • Is there anything obstructing the air distribution circuit? • Is there any clogging of Outdoor Heat Exchanger?



Check Point 3 : Check Compressor
<ul style="list-style-type: none"> • Check Compressor. (PARTS INFORMATION 2)



Check Point 4 : Replace Main PCB
▶ <u>If Check Point 1 ~ 3 do not improve the symptom, change Main PCB.</u>

Trouble shooting 15 OUTDOOR UNIT Error Method: Compressor rotor position detection error	Indicate or Display: Refer to error code table.
---	--

Detective Actuators: Outdoor unit Main PCB Compressor	Detective details: ① If the detected rotor location is out of phase with actual rotor location more than 90°, the compressor stops. After the compressor restarts, if the same operation is repeated ② within 40sec, the compressor stops again. ③ If ① and ② repeats 5 times, the compressor stops permanently.
--	---

Forecast of Cause : 1. Defective connection of electric components 2. Main PCB failure 3. Compressor failure
--

Check Point 1 : Check Noise from Compressor
<ul style="list-style-type: none"> • Turn on Power and check operation noise. <p>▶ <u>If an abnormal noise show, replace Compressor.</u></p>



Check Point 2 : Check connection of around the Compressor components
For Compressor Terminal, Main PCB <ul style="list-style-type: none"> • Check if connector is removed. • Check erroneous connection. • Check if cable is open. (Refer to PARTS INFORMATION 2) <p>>><u>Upon correcting the removed connector or mis-wiring, reset the power.</u></p>



Check Point 3: Replace Main PCB
<p>▶ <u>If Check Point 1,2 do not improve the symptom, change Main PCB.</u></p>



Check Point 4: Replace Compressor
<p>▶ <u>If Check Point 3 do not improve the symptom, change Compressor.</u></p>

Trouble shooting 16 OUTDOOR UNIT Error Method: Outdoor unit fan motor error	Indicate or Display: Refer to error code table.
--	--

Detective Actuators: Outdoor unit Main PCB Outdoor unit Fan motor	Detective details: ① When outdoor fan rotation speed is less than 100rpm in 20 seconds after fan motor starts, fan motor stops. ② After fan motor restarts, if the same operation within 60sec is repeated 3 times in a row, compressor and fan motor stops. ③ If ① and ② repeats 5 times in a row, compressor and fan motor stops permanently.
--	---

Forecast of Cause: 1. Fan rotation failure 2. Motor protection by surrounding temperature rise 3. Main PCB failure 4. Outdoor unit fan motor

Check Point 1 : Check rotation of Fan
<ul style="list-style-type: none"> Rotate the fan by hand when operation is off. (Check if fan is caught, dropped off or locked motor) <p>>>If Fan or Bearing is abnormal, replace it.</p>

↓
OK

Check Point 2 : Check ambient temp. around motor
<ul style="list-style-type: none"> Check excessively high temperature around the motor. (If there is any surrounding equipment that causes heat) <p>>>Upon the temperature coming down, restart operation.</p>

↓
OK

Check Point 3 : Check Outdoor unit fan motor
<ul style="list-style-type: none"> Check Outdoor unit fan motor. (PARTS INFORMATION 5) <p>>>If Outdoor unit fan motor is abnormal, replace Outdoor unit fan motor.</p>

↓
OK

Check Point 4 : Check Output Voltage of Main PCB							
<ul style="list-style-type: none"> Check outdoor unit circuit diagram and the voltage. (Measure at Main PCB side connector) 							
<table border="1" style="width: 100%;"> <thead> <tr> <th>Read wire</th> <th>DC voltage</th> </tr> </thead> <tbody> <tr> <td>Red - Black</td> <td>290V (AC115V-10%)~ 360V (AC115+10%)</td> </tr> <tr> <td>White - Black</td> <td>15 ± 1.5V</td> </tr> </tbody> </table>	Read wire	DC voltage	Red - Black	290V (AC115V-10%)~ 360V (AC115+10%)	White - Black	15 ± 1.5V	
Read wire	DC voltage						
Red - Black	290V (AC115V-10%)~ 360V (AC115+10%)						
White - Black	15 ± 1.5V						
<p>▶ If the voltage is not correct, replace Main PCB.</p>							

Trouble shooting 17 <u>INDOOR UNIT Error Method:</u> 4-way valve error	<u>Indicate or Display:</u> Refer to error code table.
---	---

<u>Detective Actuators:</u> Indoor unit Controller PCB Heat Ex. temperature thermistor Room temperature thermistor 4-way valve	<u>Detective details:</u> When the indoor heat exchanger temperature is compared with the room temperature, and either following condition is detected continuously two times, the compressor stops. <ul style="list-style-type: none"> ▪ Cooling or Dry operation [Indoor heat exchanger temp.] - [Room temp.] > 10degC (20°F) ▪ Heating operation [Indoor heat exchanger temp.] - [room temp.] < - 10degC (-20°F) If the same operation is repeated 5 times, the compressor stops permanently.
---	--

<u>Forecast of Cause :</u> 1. Connector connection failure 2. Thermistor failure 3. Coil failure 4. 4-way valve failure 5. Controller PCB failure
--

Check Point 1 : Check connection of Connector
<ul style="list-style-type: none"> ▪ Check if connector is removed. ▪ Check erroneous connection. ▪ Check if thermistor cable is open. >> <u>Upon correcting the removed connector or mis-wiring, reset the power.</u>



Check Point 2 : Check each thermistor
<ul style="list-style-type: none"> ▪ Isn't it fallen off the holder? ▪ Is there a cable pinched? >> <u>Check characteristics of thermistor (Refer to Trouble shooting 5, 6), If defective, replace the thermistor</u>



Check Point 3 : Check the solenoid coil and 4-way valve
<p>[Solenoid coil]</p> <ul style="list-style-type: none"> ▪ Remove CN30 from PCB and check the resistance value of coil. Resistance value is 1.88kΩ ~ 2.29kΩ (at 20°C (68°F)). >> <u>If it is Open or abnormal resistance value, replace Solenoid Coil.</u> <p>[4-way valve]</p> <ul style="list-style-type: none"> ▪ Check each piping temperature, and the location of the valve by the temperature difference. >> <u>If the value location is not proper, replace 4-way valve.</u>



Check Point 4 : Replace Controller PCB
▶ <u>If Check Point 1- 3 do not improve the symptom, replace Controller PCB.</u>

Trouble shooting 18 OUTDOOR UNIT Error Method: Discharge temperature error	Indicate or Display: Refer to error code table.
---	--

Detective Actuators: Outdoor unit Main PCB Discharge temperature thermistor	Detective details: <ul style="list-style-type: none"> "Protection stop by "discharge temperature $\geq 110\text{degC}$ during compressor operation"" generated 2 times within 24 hours.
--	---

Forecast of Cause : <ul style="list-style-type: none"> 1. 2/ 3-way valve not opened 2. Capillary tube, strainer clogged 3. Outdoor unit operation failure, foreign matter on heat exchanger 4. Discharge temperature thermistor failure 5. Insufficient refrigerant 6. Main PCB failure
--

<Cooling operation>

Check Point 1 : Check if 3-way valve(gas side) is open.
<ul style="list-style-type: none"> If the 3-way valve(gas side) was closed, open the 3-way valve(gas side) and check operation.

↓
OK

Check Point 2 : Check the capillary tube, strainer
<ul style="list-style-type: none"> Capillary tube, Strainer(after Capillary) clogging check. Refer to "Service Parts Information 3".

↓
OK

Check Point 3 : Check the outdoor unit fan,heat exchanger
<ul style="list-style-type: none"> Check for foreign object at heat exchanger Check if fan can be rotated by hand. Motor check (PARTS INFORMATION 5)

↓
OK

Check Point 4 : Check the discharge thermistor
<ul style="list-style-type: none"> Discharger thermistor characteristics check. (Check by disconnecting thermistor from PCB.) * For the characteristics of the thermistor, refer to the "Trouble shooting 10".

↓
OK

Check Point 5 : Check the refrigerant amount
<ul style="list-style-type: none"> Leak check

<Heating operation>

Check Point 1 : Check if 2-way valve(liquid side) is open.
<ul style="list-style-type: none"> If the 2-way valve(liquid side) was closed, open the 2-way valve(liquid side) and check operation.

↓
OK

Check Point 2 : Check the capillary tube, strainer
<ul style="list-style-type: none"> Capillary tube, Strainer(before Capillary) clogging check. Refer to "Service Parts Information 3".

↙
OK

2-3 TROUBLE SHOOTING WITH NO ERROR CODE

Trouble shooting 19

Indoor Unit - No Power

Forecast of Cause:

1. Power supply failure
2. External cause
3. Electrical components defective

Check Point 1 : Check Installation Condition

- Isn't the breaker down?
- Check loose or removed connection cable.
- >> **If abnormal condition is found, correct it by referring to Installation Manual or Data & Technical Manual.**

↓ OK

Check Point 2 : Check external cause at Indoor and Outdoor (Voltage drop or Noise)

- Instant drop ----- Check if there is a large load electric apparatus in the same circuit.
- Momentary power failure ----- Check if there is a defective contact or leak current in the power supply circuit.
- Noise ----- Check if there is any equipment causing harmonic wave near electric line.
(Neon bulb or electric equipment that may cause harmonic wave)
Check the complete insulation of grounding.

↓ OK

Check Point 3 : Check Electrical Components

- Check the voltage of power supply.
- >> **Check if AC103 - 127V appears at Outdoor Unit Terminal L - N.**

↓ YES

- Check Fuse in Main PCB.
- >> **If Fuse is open, check if the wiring between Terminal and Main PCB is loose, and replace Fuse.**
- Check Varistor in Main PCB.
- >> **If Varistor is defective, there is a possibility of an abnormal power supply. Check the correct power supply and replace Varistor. Upon checking the normal power supply, replace Varistor.**



NO

Trouble shooting 20

Outdoor Unit - No Power

Forecast of Cause:

1. Power supply failure
2. External cause
3. Electrical Components defective

Check Point 1 : Check Installation Condition

- Isn't the breaker down?
- Check loose or removed connection cable.
- >> **If abnormal condition is found, correct it by referring to Installation Manual or Data & Technical Manual.**

OK

Check Point 2 : Check external cause at Indoor and Outdoor (Voltage drop or Noise)

- Instant drop ----- Check if there is a large load electric apparatus in the same circuit.
- Momentary power failure ----- Check if there is a defective contact or leak current in the power supply circuit.
- Noise ----- Check if there is any equipment causing harmonic wave near electric line.
(Neon bulb or electric equipment that may cause harmonic wave)
Check the complete insulation of grounding.

OK

Check Point 3 : Check Electrical Components

- Check the voltage of power supply.
- >> **Check if AC103 - 127V appears at Outdoor Unit Terminal L - N.**

YES

- Check Fuse in Main PCB.
- >> **If Fuse is open, check if the wiring between Terminal and Main PCB is loose, and replace Fuse.**
- Check Varistor in Main PCB.
- >> **If Varistor is defective, there is a possibility of an abnormal power supply. Check the correct power supply and replace Varistor. Upon checking the normal power supply, replace Varistor.**

OK

► **If the symptom does not change by above Check 3, replace Main PCB.**

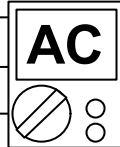

NO

Trouble shooting 21

No Operation (Power is ON)

Forecast of Cause:

1. Setting/ Connection failure
2. External cause
3. Electrical component defective

Check Point 1 : Check indoor and outdoor installation condition

- Are these Indoor Unit, Outdoor Unit, and Remote Control suitable model numbers to connect?
>> **If there is some abnormal condition, correct it by referring to Installation manual and Data & Technical Manual.**

OK

Turn off Power and check/ correct followings.

- Is there loose or removed communication line of Indoor Unit and Outdoor Unit?

OK

Check Point 2 : Check external cause at Indoor and Outdoor (Voltage drop or Noise)

- Instant drop ----- Check if there is a large load electric apparatus in the same circuit.
- Momentary power failure ----- Check if there is a defective contact or leak current in the power supply circuit.
- Noise ----- Check if there is any equipment causing harmonic wave near electric line.
(Neon bulb or electric equipment that may cause harmonic wave)
Check the complete insulation of grounding.

OK

► **If the symptom does not change by above Check 1, 2, replace Main PCB.**

Trouble shooting 22

No Cooling / No Heating

Forecast of Cause:

1. Indoor Unit error
2. Outdoor unit error
3. Effect by surrounding environment
4. Connection pipe / Connection wire failure
5. Refrigeration cycle failure

Check Point 1 : Check Indoor unit

- Does Indoor unit Fan run on High fan?
- Is Air filter dirty?
- Is Heat exchanger clogged?
- Check if Energy save function is operated.



Check Point 2 : Check Outdoor unit operation

- Check if Outdoor unit is operating
- Check any objects that obstruct the air flow route.
- Check clogged Heat Exchanger.
- Is the Valve open?



Check Point 3 : Check Site condition

- Is capacity of Indoor unit fitted to room size?
- Any windows open? or direct sunlight ?



Check Point 4 : Check Indoor/ Outdoor installation condition

- Check connection pipe (specified pipe length & Pipe diameter?)
- Check any loose or removed communication line.
- >> **If there is an abnormal condition, correct it by referring to Installation Manual or Data & Technical Manual.**



Check Point 5 : Check Refrigeration cycle

- Check if Strainer is clogged (Refer to the figure at right).
- Measure Gas pressure and if there is a leakage, correct it.
- >> **When recharging the refrigerant, make sure to perform vacuuming, and recharge the specified amount.**
- Check Capillary tube (PARTS INFORMATION 3)
- Check Compressor (PARTS INFORMATION 1,2)

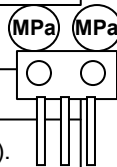

Attention

Strainer normally does not have temperature difference between inlet and outlet as shown in ①, but if there is a difference like shown in ②, there is a possibility of inside clogged. In this case, replace Strainer.

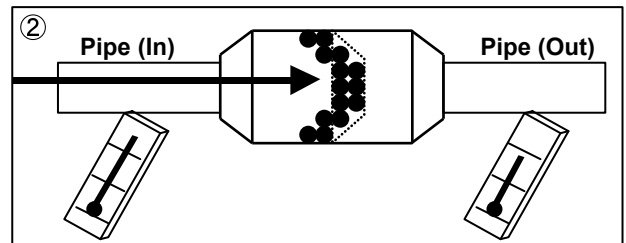
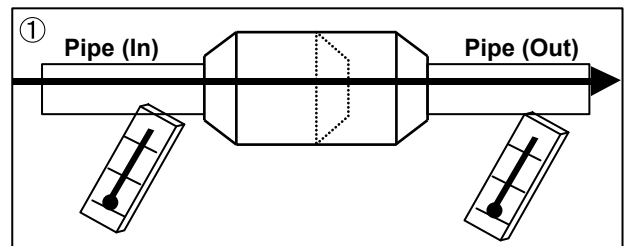

Trouble shooting 23
Abnormal Noise

- Forecast of Cause :
1. Abnormal installation (Indoor/ Outdoor)
 2. Fan failure (Indoor/ Outdoor)
 3. Compressor failure (Outdoor)

Diagnosis method when abnormal noise is occurred

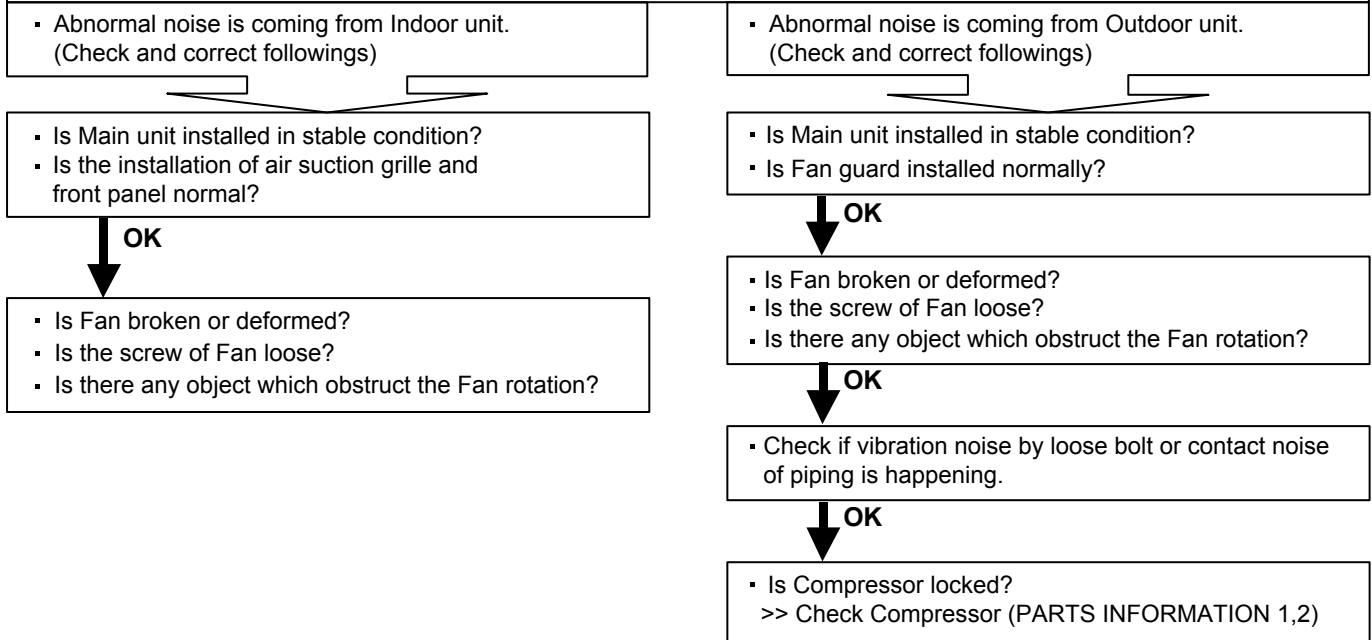

Trouble shooting 24
Water Leaking

- Forecast of Cause:
1. Erroneous installation
 2. Drain hose failure

Diagnosis method when water leak occurs

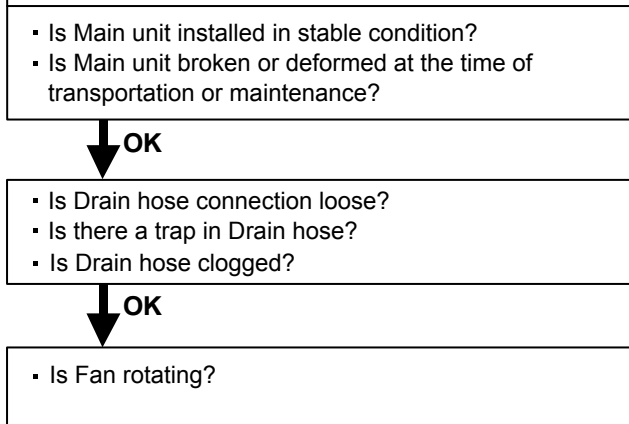

Diagnosis method when water is spitting out.

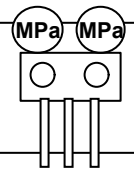
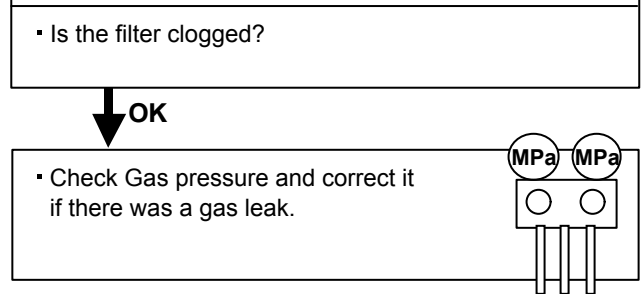

2-4 SERVICE PARTS INFORMATION

SERVICE PARTS INFORMATION 1

Compressor

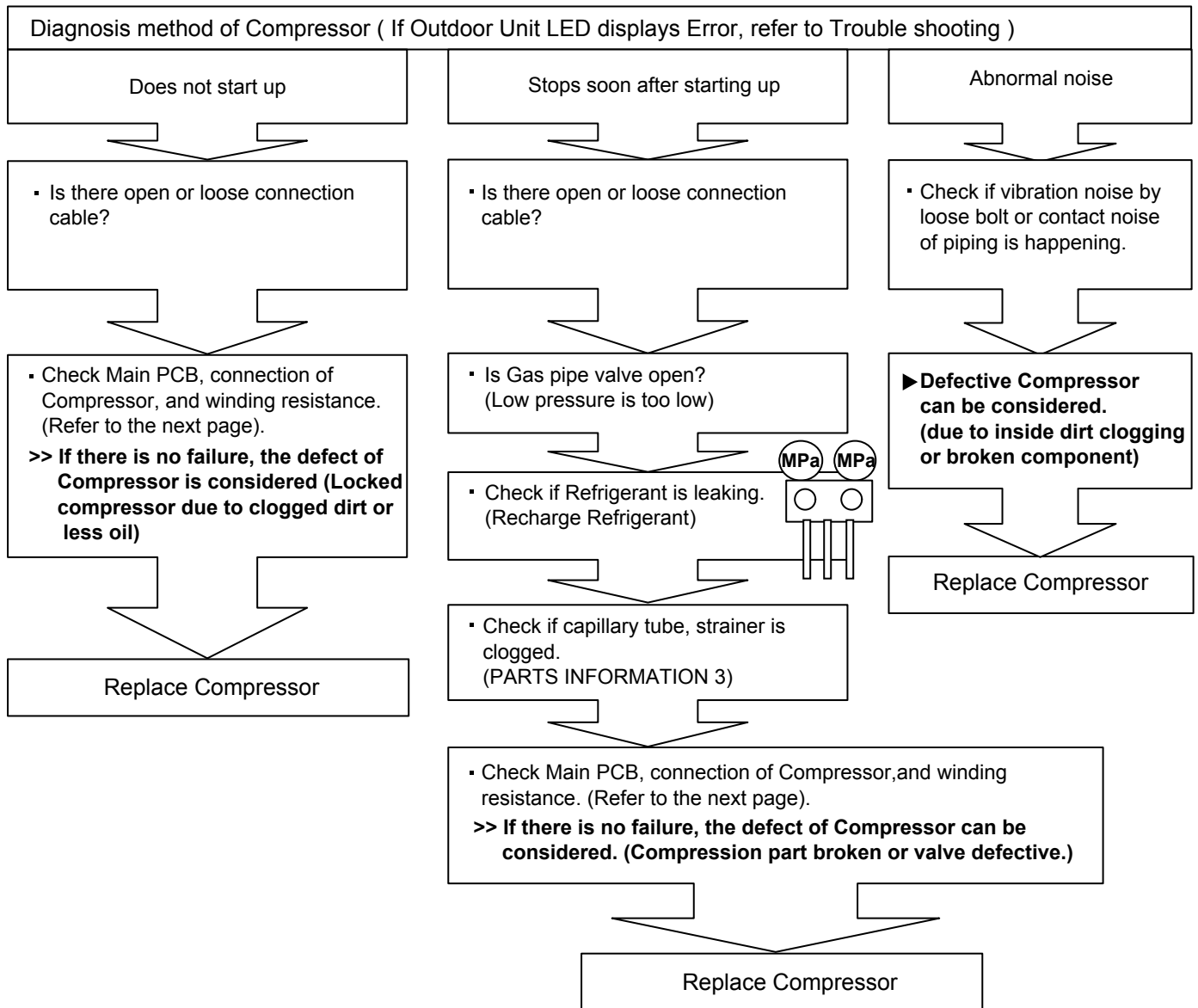

SERVICE PARTS INFORMATION 2

Inverter Compressor

Check Point 1 : Check Connection

- Check terminal connection of Compressor (loose or incorrect wiring)

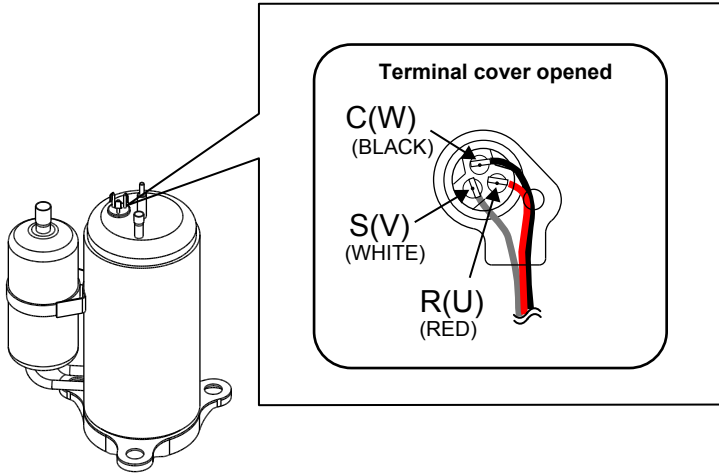

Check Point 2 : Check Winding Resistance

- Check winding resistance of each terminal

► **If the resistance value is 0Ω or infinite, replace Compressor.**

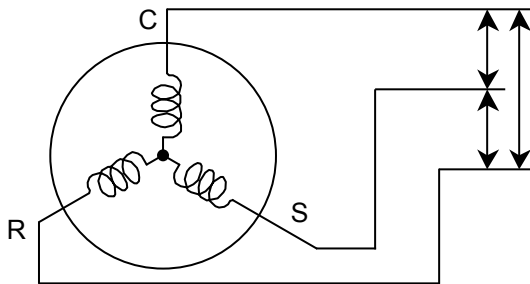

Resistance Value :
1.3Ω at 20°C (68°F)



Check Point 3 : Replace Main PCB

► **If the symptom does not change with above Check 1, 2, replace Main PCB.**

SERVICE PARTS INFORMATION 3

Outdoor unit Electronic Expansion Valve (EEV)

Check Point 1 : Check Connections

- Check connection of connector (CN40) (Loose connector or open cable)

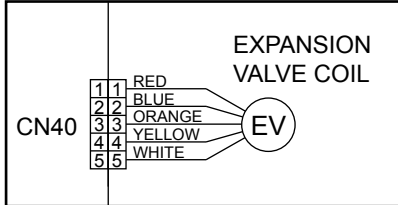

Check Point 2 : Check Coil of EEV

- Remove connector, check each winding resistance of Coil.

Read wire	Resistance value
White - Red	$46 \Omega \pm 4 \Omega$ at 20°C
Yellow - Red	
Orange - Red	
Blue - Red	

► **If Resistance value is abnormal, replace EEV.**

Check Point 3 : Check Voltage from Main PCB.

- Remove Connector and check Voltage (DC12V)

► **If it does not appear, replace Main PCB.**



Check Point 4 : Check Noise at start up

- Turn on Power and check operation noise.

► **If an abnormal noise does not show, replace Main PCB.**

Check Point 5 : Check Opening and Closing Operation of Valve

When Valve is closed, it has a temp. difference between Inlet and Outlet.

CLOSE
Example : Hot Gas

Pipe (In)
Hi TEMP.

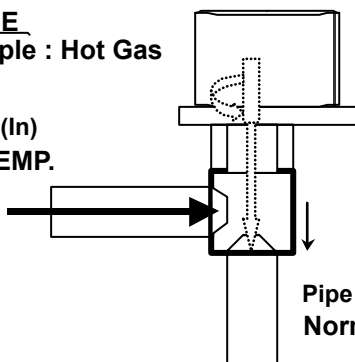

If it is open, it has no temp. difference between Inlet and Outlet.

OPEN
Example : Hot Gas

Pipe (In)
Hi TEMP.

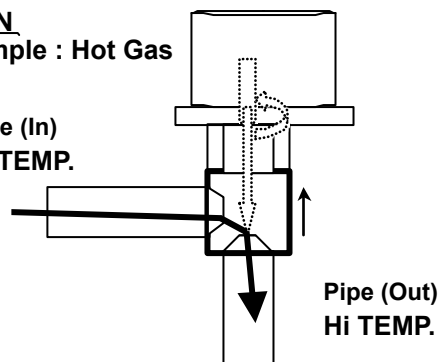

Check Point 6 : Check Strainer

Strainer normally does not have temperature difference between inlet and outlet as shown in ①, but if there is a difference as shown in ②, there is a possibility of inside clogged. In this case, replace Strainer.

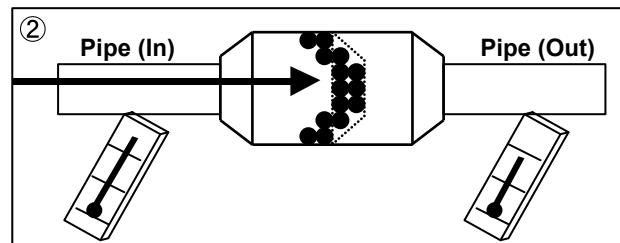
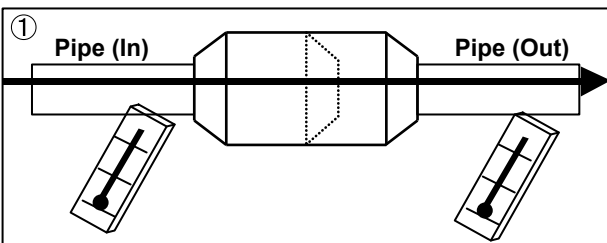

SERVICE PARTS INFORMATION 4

Indoor unit fan motor

Check Point 1 : Check rotation of Fan

- Rotate the fan by hand when operation is off.
(Check if fan is caught, dropped off or locked motor)
- >>If Fan or Bearing is abnormal, replace it.**

Check Point 2 : Check resistance of Indoor Fan Motor

- Refer to below. Circuit-test "Vm" and "GND" terminal.
(Vm: DC voltage, GND: Earth terminal)
- >>If they are short-circuited (below 300 k Ω), replace Indoor fan motor and Controller PCB.**

Pin number (wire color)	Terminal function (symbol)
1 (Blue)	Feed back (FG)
2 (Yellow)	Speed command (Vsp)
3 (White)	Control voltage (Vcc)
4 (Black)	Earth terminal (GND)
5	No function
6 (Red)	DC voltage (Vm)

SERVICE PARTS INFORMATION 5

Outdoor unit fan motor

Check Point 1 : Check rotation of Fan

- Rotate the fan by hand when operation is off.
(Check if fan is caught, dropped off or locked motor)
- >>If Fan or Bearing is abnormal, replace it.**

Check Point 2 : Check resistance of Outdoor Fan Motor

- Refer to below. Circuit-test "Vm" and "GND" terminal.
(Vm: DC voltage, GND: Earth terminal)
- >>If they are short-circuited (below 300 k Ω), replace Outdoor fan motor and Main PCB.**

Pin number (wire color)	Terminal function (symbol)
1 (Red)	DC voltage (Vm)
2	No function
3	No function
4 (Black)	Earth terminal (GND)
5 (White)	Control voltage (Vcc)
6 (Yellow)	Speed command (Vsp)
7 (Brown or Blue)	Feed back (FG)

WALL MOUNTED type INVERTER

3 . APPENDING DATA

3-1. FUNCTION SETTING

3-1-1 INDOOR UNIT

- Follow the instructions in the Local Setup Procedure, which is supplied with the remote control, in accordance with the installed condition.
After the power is turned on, perform the Function Setting on the remote control.
- The settings may be selected between the following two: Function Number or Setting Value.
- Settings will not be changed if invalid numbers or setting values are selected.

1-1. Setting the Filter Sign

The indoor unit has a sign to inform the user that it is time to clean the filter.

Select the time setting for the filter sign display interval in the table below according to the amount of dust or debris in the room.

If you do not wish the filter sign to be displayed, select the setting value for "No indication".

(◆ . . . Factory setting)

Setting Description	Function Number	Setting Value
Standard (400 hours)	11	00
Long interval (1000 hours)		01
Short interval (200 hours)		02
◆ No indication		03

1-2. Cooling Room Temperature Correction

Depending on the installed environment, the room temperature sensor may require a correction. The settings may be selected as shown in the table below.

(◆ . . . Factory setting)

Setting Description	Function Number	Setting Value
◆ Standard	30	00
Slightly lower control		01
Lower control		02
Warmer control		03

1-3. Heating Room Temperature Correction

Depending on the installed environment, the room temperature sensor may require a correction. The settings may be selected as shown in the table below.

(◆ . . . Factory setting)

Setting Description	Function Number	Setting Value
◆ Standard	31	00
Lower control		01
Slightly warmer control		02
Warmer control		03

1-4. Setting the Auto Restart

Enable or disable automatic system restart after a power outage.

(◆ . . . Factory setting)

Setting Description	Function Number	Setting Value
◆ Yes	40	00
No		01

*Auto restart is an emergency function such as for power failure etc.

Do not start and stop the indoor unit by this function in normal operation.

Be sure to operate by the control unit, or external input device.

1-5. Remote controller signal code

Change the indoor unit Signal Code, depending on the remote controllers.

(◆ . . . Factory setting)

Setting Description	Function Number	Setting Value
◆ A	44	00
B		01
C		02
D		03

3-1-2 Procedures to change the Function Setting for wireless RC

- The function settings of the control of the indoor unit can be changed by this procedure according to the installation conditions. Incorrect settings can cause the indoor unit malfunction.
- After the power is turned on, perform the "FUNCTION SETTING" according to the installation conditions using the remote controller.
- The settings may be selected between the following two: Function Number or Setting Value.
- Settings will not be changed if invalid numbers or setting values are selected.

■ PREPARATION

- Turn on the power
 - *By turning on the power indoor units, so make sure the piping air-tight test and vacuuming have been conducted before turning on the power.
 - *Also check again to make sure no wiring mistakes were made before turning on the power.

■ FUNCTION SETTING METHOD (for Wireless remote controller)

Entering the Function Setting Mode

- While pressing the FAN button and SET TEMP.(▲) button simultaneously, press the RESET button to enter the function setting mode.

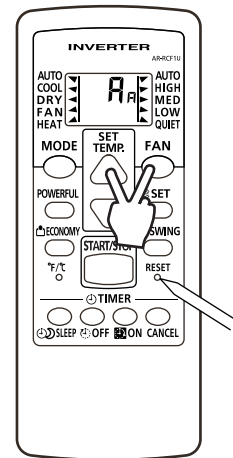

STEP 1.

Setting the Remote controller Signal Code

Use the following steps to select the signal code of the remote controller.
(Note that the air conditioner cannot receive a signal code if the air conditioner has not been set for the signal code.)

The signal code that is set through this process are applicable only to the signal in the FUNCTION SETTING.

For details on how to set the signal code through the normal process, refer to SELECTING THE REMOTE CONTROLLER SIGNAL CODE.

- (1) Press the SET TEMP.(▲)(▼) button to change the signal code between $\bar{A} \rightarrow b \rightarrow \bar{C} \rightarrow d$.
Match the code on the display to the air conditioner signal code.
(initially set to \bar{A})
(If the signal code does not need to be selected, press the MODE button and proceed to STEP 2.)

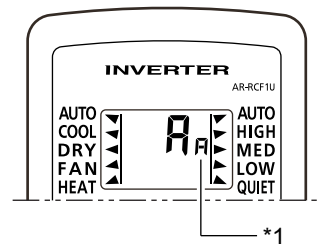

- (2) Press the MODE button to accept the signal code, and proceed to STEP 2.

The air conditioner signal code is set to \bar{A} prior to shipment.
Contact your retailer to change the signal code.

The remote controller resets to signal code \bar{A} when the batteries in the remote controller are replaced.
If you use a signal code other than signal code \bar{A} , reset the signal code after replacing the batteries.
If you do not know the air conditioner signal code setting, try each of the signal codes ($\bar{A} \rightarrow b \rightarrow \bar{C} \rightarrow d$) until you find the code which operates the air conditioner.

Note :

*1) Small "A" is displayed on the right of the signal code during the FUNCTION SETTING.

STEP 2. Selecting the Function Number and Setting Value

- (1) Press the SET TEMP.(▲)(▼) buttons to select the function number.
(Press the MODE button to switch between the left and right digits.)

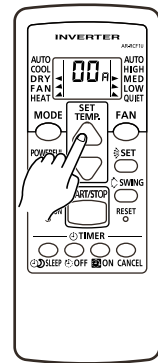

- (2) Press the FAN button to proceed to setting the value.
(Press the FAN button again to return to the function number selection.)

- (3) Press the SET TEMP.(▲)(▼) buttons to select the setting value.
(Press the MODE button to switch between the left and right digits.)

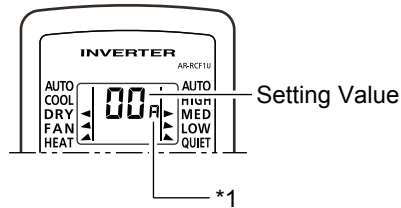
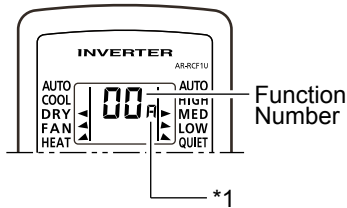

- (4) Press the SLEEP button, then after you hear the beep emitted from the indoor unit, press the START/STOP button to confirm the settings.

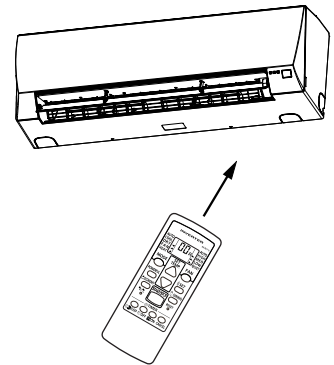

- (5) Press the RESET button to cancel the function setting mode.
(6) After completing the FUNCTION SETTING, be sure to turn off the power and turn it on again.

CAUTION

After turning off the power, wait 10 seconds or more before turning on it again. The FUNCTION SETTING doesn't become effective if it doesn't do so.

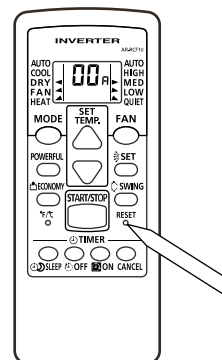

Note :

*1) Small "F" is displayed on the right of the signal code during the FUNCTION SETTING.

■ REMOTE CONTROLLER SIGNAL CODE SETTING

Use the following steps to select the signal code of the remote controller.
(Note that the air conditioner cannot receive a signal code if the air conditioner has not been set for the signal code.)

- (1) Press the MODE button for at least 5 seconds to display the current signal code.
(initially set to \overline{A}).
- (2) Press the SET TEMP.(▲) (▼) button to change the signal code between $\overline{A} \rightarrow \overline{b} \rightarrow \overline{c} \rightarrow \overline{d}$.
Match the code on the display to the air conditioner signal code.
- (3) Press the MODE button again. The signal code will be changed.

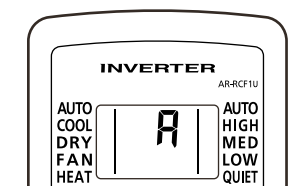

If no buttons are pressed within 30 seconds after the signal code is displayed, the display returns to the original status. In this case, start again from step 1.

The air conditioner signal code is set to \overline{A} prior to shipment.
Contact your retailer to change the signal code.

The remote controller resets to signal code \overline{A} when the batteries in the remote controller are replaced.
If you use a signal code other than signal code \overline{A} , reset the signal code after replacing the batteries.
If you do not know the air conditioner signal code setting, try each of the signal codes ($\overline{A} \rightarrow \overline{b} \rightarrow \overline{c} \rightarrow \overline{d}$) until you find the code which operates the air conditioner.

3-2. Thermistor Resistance Values

3-2-1 INDOOR UNIT

Room temperature thermistor		
Temp (°C)	Resistance(k Ω)	Voltage(V)
-10.0	55.46	0.76
-5.0	42.36	0.95
0.0	32.67	1.17
5.0	25.39	1.41
10.0	19.91	1.67
15.0	15.71	1.94
20.0	12.5	2.22
25.0	10.0	2.50
30.0	8.051	2.77
35.0	6.52	3.03
40.0	5.316	3.26
45.0	4.354	3.48

Indoor heat exchanger thermistor		
Temp (°C)	Resistance(k Ω)	Voltage(V)
-30.0	977.6	0.24
-25.0	713.2	0.33
-20.0	526.8	0.43
-15.0	392.1	0.56
-10.0	295.1	0.72
-5.0	223.3	0.91
0.0	170.7	1.13
5.0	131.4	1.38
10.0	102.1	1.64
15.0	79.81	1.92
20.0	62.9	2.21
25.0	49.84	2.50
30.0	39.78	2.78
35.0	31.92	3.05
40.0	25.8	3.30
45.0	20.94	3.52
50.0	17.11	3.72
55.0	14.05	3.90
60.0	11.6	4.06
63.0	10.36	4.14

3-2-2 OUTDOOR UNIT

Discharge thermistor		
Temp (°C)	Resistance(k Ω)	Voltage(V)
-30.0	920.3	0.07
-25.0	676.6	0.09
-20.0	503.5	0.13
-15.0	377.6	0.17
-10.0	286.3	0.22
-5.0	218.6	0.28
0.0	168.6	0.36
5.0	130.9	0.45
10.0	102.5	0.56
15.0	80.82	0.69
20.0	64.22	0.84
25.0	51.36	1.01
30.0	41.33	1.20
35.0	33.64	1.39
40.0	27.26	1.61
45.0	22.33	1.84
50.0	18.40	2.07
55.0	15.23	2.30
60.0	12.68	2.53
65.0	10.60	2.75
70.0	8.909	2.97
75.0	7.518	3.17
80.0	6.375	3.35
85.0	5.427	3.53
90.0	4.639	3.69
95.0	3.981	3.83
100.0	3.430	3.96
105.0	2.965	4.07
110.0	2.573	4.17
115.0	2.239	4.27
120.0	1.956	4.35

Outdoor heat exchanger thermistor		
Temp (°C)	Resistance(k Ω)	Voltage(V)
-30.0	87.21	0.26
-25.0	64.16	0.34
-20.0	47.78	0.45
-15.0	35.86	0.58
-10.0	27.21	0.74
-5.0	20.80	0.93
0.0	16.05	1.14
5.0	12.47	1.38
10.0	9.775	1.64
15.0	7.709	1.91
20.0	6.129	2.18
25.0	4.903	2.46
30.0	3.947	2.73
35.0	3.196	2.99
40.0	2.606	3.23
45.0	2.135	3.45
50.0	1.759	3.65
55.0	1.457	3.83
60.0	1.213	3.98
65.0	1.015	4.12
70.0	0.8531	4.24
75.0	0.7206	4.34
80.0	0.6115	4.43

Outdoor temperature thermistor		
Temp (°C)	Resistance(k Ω)	Voltage(V)
-30.0	205.7	0.78
-25.0	148.8	1.02
-20.0	109.0	1.30
-15.0	80.56	1.61
-10.0	60.23	1.94
-5.0	45.40	2.29
0.0	34.57	2.63
5.0	26.53	2.95
10.0	20.56	3.25
15.0	16.04	3.52
20.0	12.26	3.79
25.0	10.00	3.96
30.0	7.978	4.14
35.0	6.408	4.28
40.0	5.184	4.40
45.0	4.216	4.50
50.0	3.451	4.59
55.0	2.841	4.65

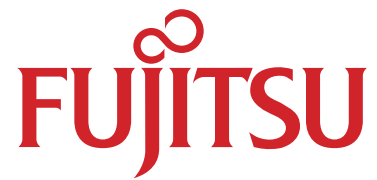

FUJITSU GENERAL LIMITED

1116, Suenaga, Takatsu-ku, Kawasaki 213-8502, Japan