



MULTI-ZONE MINI-SPLIT HEATING AND COOLING SYSTEMS

MULTI-ZONE SYSTEMS LINEUP FOR RESIDENTIAL AND LIGHT COMMERCIAL APPLICATIONS



MULTI-ZONE SERIES

- 2 TO 5 ZONES
- AOU18RLXFZ
- AOU24RLXFZ
- AOU36RLXFZ1
- AOU45RLXFZ



XLTH SERIES

- 2 TO 4 ZONES
- AOU18RLXFZH
- AOU24RLXFZH
- AOU36RLXFZH



HFI SERIES

- 2 TO 8 ZONES
- AOU48RLXFZ1

MULTI-ZONE MINI-SPLIT SYSTEMS

- Operate as few as one indoor unit or all indoor units
- Choose from 4 indoor unit styles - wall mount, slim duct, compact cassette, and floor mount
- Six combinations are ENERGY STAR® qualified
- Create hundreds of combinations based on indoor type and BTUh



- Connect 2 to 5 indoor units, depending on model
- Connect 14,000 to 54,000 BTUh
- No branch boxes or separation tubes required



18, 24, 36,000 BTUh

- Connect 2 to 4 indoor units, depending on model
- Connect 14,000 to 39,000 BTU
- eXtra Low Temp Heating down to -15°F outdoor temps
- No branch boxes or separation tubes required



- Connect 2 to 8 indoor units
- 80 to 130% connectable capacity
- Connect 39,000 to 62,000 BTU
- Branch boxes and separation tubes required



YEAR-ROUND, WHOLE HOME OR BUSINESS COMFORT

Halcyon Systems are some of today's most advanced forms of heating and air conditioning. Multi-zone outdoor units can operate from 2 to 8 indoor units simultaneously. Fujitsu's systems are super quiet as well as highly energy efficient.

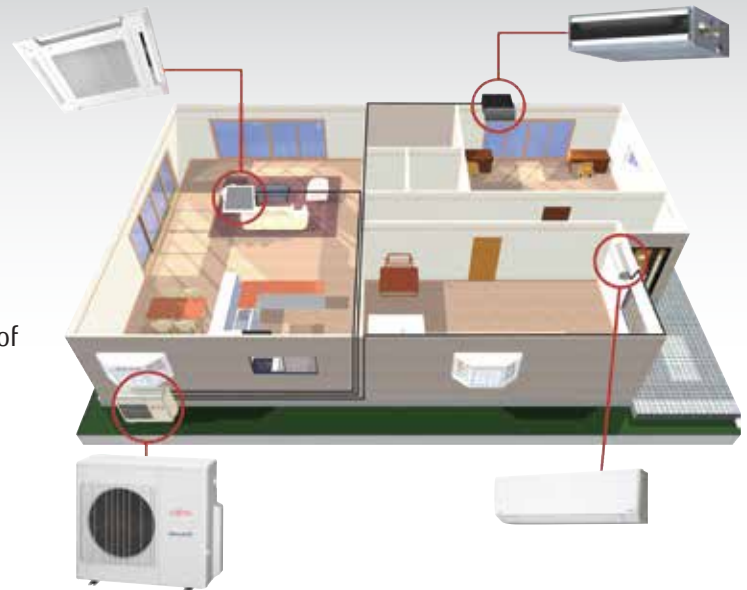

MULTI-ZONE AND XLTH SERIES SYSTEMS 18, 24, 36, AND 45,000 BTUh

AOU18RLXFZ

AOU24RLXFZ

AOU36RLXFZ1

AOU45RLXFZ

AOU18RLXFZH

AOU24RLXFZH

AOU36RLXFZH

CONNECTABLE CAPACITY

This allows connectable indoor units' total capacity to exceed outdoor unit capacity. See Allowable Combination Table on page 22.

If all indoor units are cooling or heating at the same time, the system will limit their capacity so that their total matches the outdoor unit's capacity. When a zone meets a desired set temperature it requires less capacity. The unused capacity is then distributed to the remaining indoor units, increasing their capacity.

FOR EXAMPLE

The load on a 3-bedroom home with a living room and kitchen downstairs and 3 bedrooms upstairs is 39,000 BTUh (21,000 BTU downstairs and 18,000 BTU upstairs). However the family isn't upstairs and downstairs at the same time, therefore not all units will be running simultaneously allowing 100% heating or cooling to occupied spaces. This can be achieved by our AOU36RLXFZ1 outdoor unit.

HFI SERIES SYSTEM 48,000 BTUh

AOU48RLXFZ1

130% CONNECTABLE CAPACITY

The HFI system is rated at 48,000 BTUh but you can connect up to 130%, or 62,000 BTUh of rated indoor unit capacity to the AOU48RLXFZ1. Connectable capacity allows you to connect indoor units that can exceed outdoor unit capacity. However, if you connect indoor units that exceed 100% of the outdoor unit's capacity there are limitations.

If all indoor units are cooling or heating at the same time, the system will limit their capacity so that their total matches the outdoor unit's capacity. When a zone meets a desired set temperature it requires less capacity. The unused capacity is then distributed to the remaining indoor units, increasing their capacity.

FOR EXAMPLE

The load on a small 2-story office building with a business downstairs and worker apartments upstairs is 62,000 BTUh (38,000 BTUh downstairs and 24,000 BTUh upstairs) but the workers aren't upstairs and downstairs at the same time, therefore not all units will be running simultaneously allowing 100% heating or cooling to occupied spaces.

MIX AND MATCH FLEXIBILITY

The ability to create the **right** combinations, the **right** quantity (up to 8-zones), the **right** style indoor units, and the **right** capacity. It's the **RIGHT** choice for your home or business.

MULTI-ZONE INDOOR UNITS

WALL MOUNTS					
ASU7, 9, 12RLF1	✓	✓	✓	✓	✓
ASU15RLF1		✓	✓	✓	✓
ASU18RLF		✓	✓	✓	✓
ASU24RLF			✓	✓	✓
FLOOR MOUNTS					
AGU9, 12RLF	✓	✓	✓	✓	✓
AGU15RLF		✓	✓	✓	✓
SLIM DUCTS					
ARU7, 9, 12RLF	✓	✓	✓	✓	✓
ARU18RLF		✓	✓	✓	✓
ARU24RLF			✓	✓	✓
COMPACT CASSETTES					
AUU7, 9, 12RLF	✓	✓	✓	✓	✓
AUU18RLF		✓	✓	✓	✓
OTHER					
SEPARATION TUBES: UTP-SX248A					✓
BRANCH BOXES: UTP-PU03A, B					✓

 AOU18RLXFZ	 AOU24RLXFZ	 AOU36RLXFZ1	 AOU45RLXFZ	 AOU48RLXFZ1
 AOU18RLXFZH	 AOU24RLXFZH	 AOU36RLXFZH		

MULTI-ZONE OUTDOOR UNITS

INDIVIDUAL ZONING: PERSONALIZED WHOLE HOME COMFORT

WALL MOUNTED

They mount high on a wall, out of sight and do not require ductwork, increasing energy efficiency.

- Quiet operation
- Easy maintenance
- High delivered efficiency means lower utility bills



SLIM DUCT

Mounted in a ceiling or in a framed enclosure below a ceiling. They use minimal ductwork and remain very energy efficient.

- Concealed and out of sight
- Look of central air with the efficiency of a mini-split
- Less ducts = higher efficiency

COMPACT CASSETTE

Cassettes are extremely discreet, with only the grille showing in the ceiling. They use the latest fan technology to distribute the conditioned air evenly.

- Wired remote control (wireless is optional)
- Powerful turbo fan operation
- Fits into a standard 2' x 2' ceiling grid



FLOOR MOUNTED

Floor mount systems are ideal for residential radiator replacements or any room with limited upper wall space, like a kitchen or sunroom.

- Compact size fits easily under a standard window
- Features twin airflow for improved heat delivery
- Designer wireless remote control

7, 9, 12, 15, 18, 24,000 BTUh WALL MOUNT

MULTI-ZONE INDOOR



ASU7, 9, 12, 15RLF1



ASU18, 24RLF

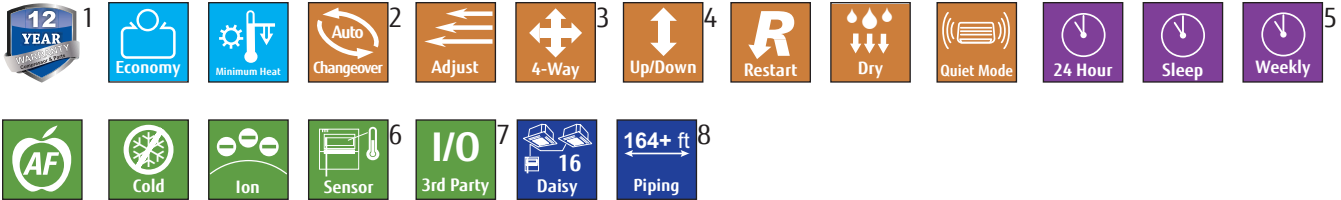

- 1 Applies when properly registered AND installed by a Fujitsu Elite Contractor in a residence. See full warranty for details.
- 2 Auto Changeover is not designed to provide rapid changes between heating and cooling operation or simultaneous heating and cooling. This feature is not recommended for systems with more than one indoor unit unless all indoor units have similar heating and cooling requirements and have similar temperature set points. If all indoor units have similar heating and cooling requirements and have similar temperature set points, auto changeover will work.

- 3 RLF models only.
- 4 RLF1 models only.
- 5 RLF1 models: Available only with optional wired remote control.
- 6 Available only with optional wired remote control and optional interface kit.
- 7 Available only with optional interface kit.
- 8 Available only when used with Flex Zone AOU48RLXFZ1 outdoor unit.



BUILT IN FILTRATION

LONG-LIFE ION DEODORIZATION FILTER



The filter deodorizes by powerfully decomposing absorbed odors using the oxidizing and reducing effects of ions generated by the ultra-fine-particle ceramic. The filter can be used for approximately 3 years if it is washed with water when dirty to restore its surface action.

APPLE-CATECHIN FILTER



Dust, mold spores and micro-organisms are absorbed onto the filter by static electricity and growth is inhibited and deactivated.

HFI ASU7RLF1, ASU9RLF1, ASU12RLF1, ASU15RLF1, ASU18RLF, ASU24RLF

		ASU7RLF1	ASU9RLF1	ASU12RLF1	ASU15RLF1	ASU18RLF	ASU24RLF
Performance		HFI	HFI	HFI	HFI	HFI	HFI
Nominal Cooling	BTUh	7,000	9,000	12,000	14,000	18,000	24,000
Nominal Heating	BTUh	8,100	10,200	13,500	16,300	20,000	27,000
Fan							
Air Circulation: Hi	CFM (m3/h)	Clg 330 (560) Htg 330 (560)	Clg 353 (600) Htg 353 (600)	Clg 388 (660) Htg 388 (660)	Clg 430 (730) Htg 430 (730)	Clg 542 (920) Htg 542 (920)	Clg 659 (1,120) Htg 647 (1,100)
Medium	CFM (m3/h)	Clg 294 (500) Htg 294 (500)	Clg 306 (520) Htg 306 (520)	Clg 330 (560) Htg 330 (560)	Clg 353 (600) Htg 362(615)	Clg 436 (740) Htg 436 (740)	Clg 530 (900) Htg 530 (900)
Low	CFM (m3/h)	Clg 253 (430) Htg 253 (430)	Clg 253 (430) Htg 253 (430)	Clg 265 (450) Htg 277 (470)	Clg 312 (530) Htg 330 (560)	Clg 365 (620) Htg 365 (620)	Clg 436 (740) Htg 436 (740)
Quiet	CFM (m3/h)	Clg 182 (310) Htg 194 (330)	Clg 182 (310) Htg 194 (330)	Clg 182 (310) Htg 194 (330)	Clg 212 (360) Htg 221 (375)	Clg 324 (550) Htg 324 (550)	Clg 365 (620) Htg 365 (620)
Fan Speed Stage		4+auto	4+auto	4+auto	4+auto	4+auto	4+auto
Sound							
Indoor Sound Level (Clg/Htg): Hi	dB(A)	36/36	37/37	40/40	42/42	43/44	49/48
Medium	dB(A)	32/32	33/33	36/36	38/38	37/37	42/42
Low	dB(A)	29/29	29/29	30/31	33/35	33/33	37/37
Quiet	dB(A)	21/22	21/22	21/22	25/27	31/31	33/33
Electrical							
Voltage/Frequency/Phase		208-230/60/1	208-230/60/1	208-230/60/1	208-230/60/1	208-230/60/1	208-230/60/1
Current Rated: Cooling	Amps	0.13	0.15	0.19	0.25	0.32	0.53
Current Rated: Heating	Amps	0.13	0.15	0.19	0.25	0.32	0.53
Input Power	W	15	17	22	28	41	69
Size & Weight							
Net Weight	lbs. (kg)	19 (8.5)	19 (8.5)	19 (8.5)	19 (8.5)	31 (14)	31 (14)
Dimensions: Height	Inch	10-1/2	10-1/2	10-1/2	10-1/2	12-5/8	12-5/8
	mm	268	268	268	268	320	320
Width	Inch	33-1/16	33-1/16	33-1/16	33-1/16	39-1/4	39-1/4
	mm	840	840	840	840	998	998
Depth	Inch	8	8	8	8	9	9
	mm	203	203	203	203	228	228
Refrigerant		R410A	R410A	R410A	R410A	R410A	R410A
Additional Data							
Air Direction: Horizontal		Manual	Manual	Manual	Manual	Auto	Auto
Vertical		Auto	Auto	Auto	Auto	Auto	Auto
Primary Air Filter		Washable	Washable	Washable	Washable	Washable	Washable
Ion Deodorizing Filter		Disposable	Disposable	Disposable	Disposable	Disposable	Disposable
Apple-Catechin Filter		Disposable	Disposable	Disposable	Disposable	Disposable	Disposable
Lineset Size	Inch	suc 3/8 dis 1/4	suc 3/8 dis 1/4	suc 3/8 dis 1/4	suc 1/2 dis 1/4	suc 1/2 dis 1/4	suc 5/8 dis 1/4



ENERGY STAR® QUALIFYING SYSTEMS:

OUTDOOR UNIT	INDOOR UNIT TYPE		
	Non-ducted	Ducted	Mixed
AOU18RLXFZ	★	--	--
AOU24RLXFZ	★	--	--
AOU36RLXFZ1	--	--	--
AOU45RLXFZ	--	--	--
AOU18RLXFZH	★	--	★
AOU24RLXFZH	★	--	★
AOU36RLXFZH	★	--	★

7, 9, 12, 18, 24,000 BTUh SLIM DUCT

MULTI-ZONE INDOOR



- 1 Applies when properly registered AND installed by a Fujitsu Elite Contractor in a residence. See full warranty for details.
- 2 Available only with optional wireless remote control.
- 3 Auto Changeover is not designed to provide rapid changes between heating and cooling operation or simultaneous heating and cooling. This feature is not recommended for systems with more than one indoor unit unless all indoor units have similar heating and cooling requirements and have similar temperature set points. If all indoor units have similar heating and cooling requirements and have similar temperature set points, auto changeover will work.
- 4 Available only with optional interface kit.
- 5 Available only when used with Flex Zone AOU48RLXFZ1 outdoor unit.

FLEXIBLE INSTALLATION

Horizontal or vertical, though internal drain pump will not operate when the unit is mounted in a vertical configuration.

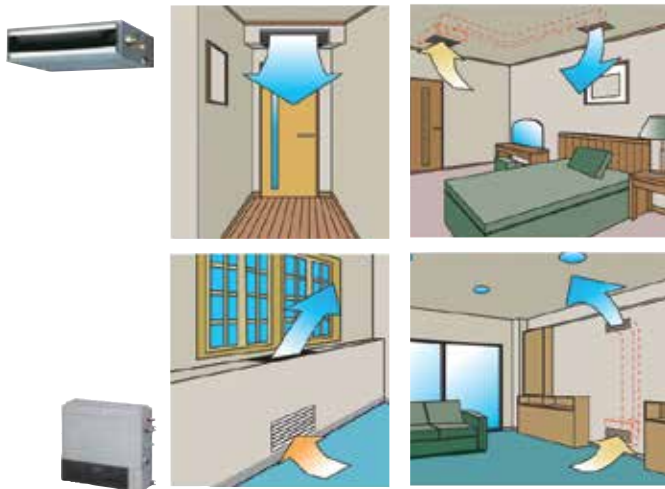

SLIM DUCT

Adaptable when ceiling cavity is small and there is no slope for drain.

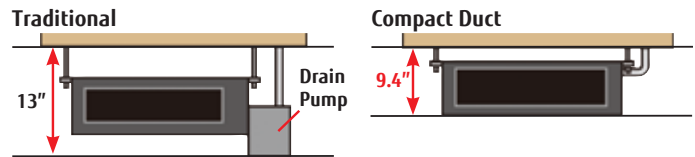

FIELD SUPPLIED FILTERS

Filters are sized to keep velocities and static pressure loss low. This will ensure sufficient static pressure is available for ductwork, fittings and supply and return grilles. Alternative filter sizes with equivalent face areas can be used.

	ARU7RLF	ARU9RLF	ARU12RLF	ARU18RLF	ARU24RLF
CFM	323	353	383	554	785
Typical Filter Size	12 x 20	12 x 20	12 x 20	14 x 25	18 x 30
Velocity, FPM	194	212	230	228	209
Unit External SP, in. W.C.	0.36	0.36	0.36	0.36	0.20
1" Fiberglass Filter					
SP Loss, in. W.C.	0.04	0.04	0.05	0.04	0.04
Available Static Pressure	0.32	0.32	0.31	0.32	0.16
1" MERV 8 Pleated Filter					
SP Loss, in. W.C.	0.10	0.12	0.14	0.14	0.12
Available Static Pressure	0.26	0.24	0.22	0.22	0.08
2" MERV 8 Pleated Filter					
SP Loss, in. W.C.	0.06	0.07	0.08	0.08	0.07
Available Static Pressure	0.30	0.29	0.28	0.28	0.13

HFI ARU7RLF, ARU9RLF, ARU12RLF, ARU18RLF, ARU24RLF

		ARU7RLF	ARU9RLF	ARU12RLF	ARU18RLF	ARU24RLF
Performance		HFI	HFI	HFI	HFI	HFI
Nominal Cooling	BTUh	7,000	9,000	12,000	18,000	24,000
Nominal Heating	BTUh	8,100	10,200	13,500	20,000	27,000
Fan						
Air Circulation: Hi	CFM (m3/h)	323 (550)	353 (600)	383 (650)	554 (940)	783 (1,330)
Medium	CFM (m3/h)	288 (490)	324 (550)	353 (600)	518 (880)	730 (1,240)
Low	CFM (m3/h)	276 (470)	294 (500)	324 (550)	483 (820)	648 (1,100)
Quiet	CFM (m3/h)	259 (440)	265 (450)	283 (480)	442 (750)	607 (1,030)
Fan Speed Stage		4 + Auto	4 + Auto	4 + Auto	4 + Auto	4 + Auto
Sound						
Indoor Sound Level (Clg/Htg): Hi	dB(A)	28/28	28/28	29/29	32/33	33/35
Medium	dB(A)	26/26	27/26	28/28	31/32	32/34
Low	dB(A)	25/25	26/25	27/27	30/31	30/32
Quiet	dB(A)	24/24	25/24	26/24	29/29	29/29
Electrical						
Voltage/Frequency/Phase		208-230/60/1	208-230/60/1	208-230/60/1	208-230/60/1	208-230/60/1
Static Pressure	W. C.	0 ~ 0.36	0 ~ 0.36	0 ~ 0.36	0 ~ 0.36	0 ~ 0.20
Current Rated: Cooling	Amps	0.30	0.30	0.35	0.44	0.66
Current Rated: Heating	Amps	0.30	0.30	0.35	0.44	0.66
Input Power	W	33	49	58	73	111
Size & Weight						
Net Weight	lbs. (kg)	37 (17)	41 (19)	41 (19)	50 (23)	59 (27)
Dimensions: Height	Inch	7-25/32	7-25/32	7-25/32	7-25/32	7-25/32
	mm	198	198	198	198	198
Width	Inch	27-9/16	27-9/16	27-9/16	35-7/16	43-5/16
	mm	700	700	700	900	1,100
Depth	Inch	24-13/32	24-13/32	24-13/32	24-13/32	24-13/32
	mm	620	620	620	620	620
Supply Duct Flange Dimensions: Height	Inch	5-15/16	5-15/16	5-15/16	5-15/16	5-15/16
	mm	151	151	151	151	151
Width	Inch	25-19/32	25-19/32	25-19/32	33-15/32	41-11/32
	mm	650	650	650	850	1,050
Depth	Inch	3/4	3/4	3/4	3/4	3/4
	mm	19	19	19	19	19
Return Duct Dimensions: Height	Inch	6	6	6	6	6
	mm	152	152	152	152	152
Width	Inch	22	22	22	30	37-3/4
	mm	559	559	559	762	959
Height	Inch	3/4 (Flat)	3/4 (Flat)	3/4 (Flat)	3/4 (Flat)	3/4 (Flat)
	mm	19 (Flat)	19 (Flat)	19 (Flat)	19 (Flat)	19 (Flat)
Refrigerant		R410A	R410A	R410A	R410A	R410A
Additional Data						
Air Filter		Washable	Washable	Washable	Washable	Washable
Lineset Size	Inch	suc 3/8 dis 1/4	suc 3/8 dis 1/4	suc 3/8 dis 1/4	suc 1/2 dis 1/4	suc 5/8 dis 1/4

7, 9, 12, 18,000 BTU_h COMPACT CASSETTES

MULTI-ZONE INDOOR

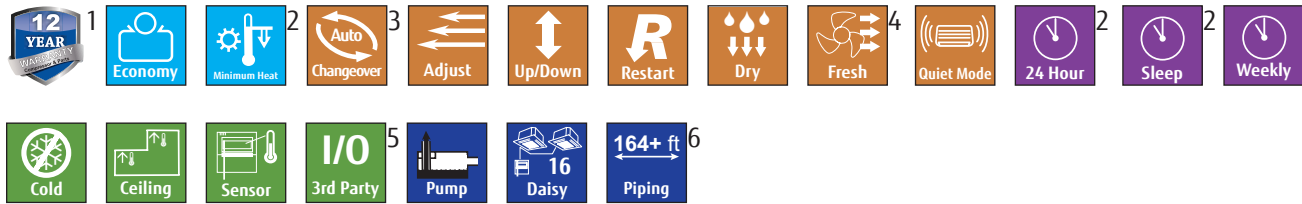

- 1 Applies when properly registered AND installed by a Fujitsu Elite Contractor in residence. See full warranty for details.
- 2 Available only with optional wireless remote control.
- 3 Auto Changeover is not designed to provide rapid changes between heating and cooling operation or simultaneous heating and cooling. This feature is not recommended for systems with more than one indoor unit unless all indoor units have similar heating and cooling requirements and have similar temperature set points. If all indoor units have similar heating and cooling requirements and have similar temperature set points, auto changeover will work.
- 4 Requires Fujitsu's Optional Fresh Air Kit part #UTZ-VXAA. Allows for a 4-inch flex duct connection. Requires a field supplied duct booster fan capable of 60 CFM at .2"W.C. or 90 CFM at .4"W.C. For fan static pressure requirements, see installation manual. Add hood, filter and duct losses for fan total static pressure requirements. Will add 4" to the height of the indoor unit.
- 5 Available only with optional Interface kit. Operation monitoring and On/Off control only.
- 6 Available only when used with Flex Zone AOU48RLXFZ1 outdoor unit.

EASY INSTALLATION

Fits into a standard 2' x 2' ceiling grid. Dimensions of outer grille are 24-7/16" x 24-7/16". There is no overlapping of adjacent ceiling tiles, it can be installed next to recessed light fixtures.



2-STAGE TURBO FAN

Air distribution is evenly spread across the heat exchanger by the 2 stage turbo fan which produces two separate airflow streams.

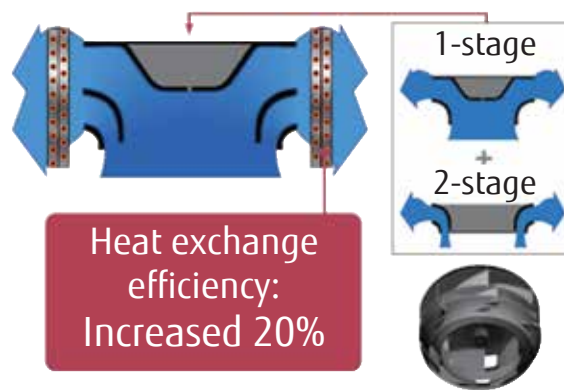

IMPROVED AIRFLOW DISTRIBUTION

The louver design allows steady distribution of uniformly cooled or heated air over a wide area .

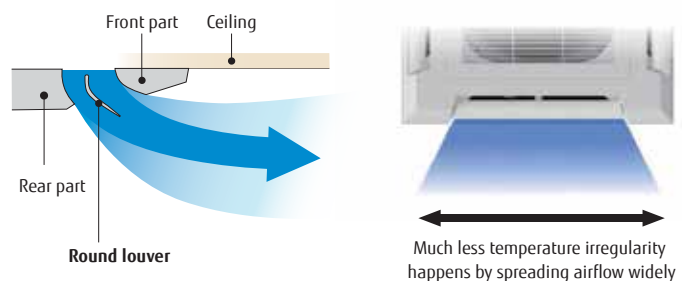

Fresh Air Kit
UTZ-VXAA
Mixes room air then passes through the heat exchanger. (see footnote #4, above)



HFI AUU7RLF, AUU9RLF, AUU12RLF, AUU18RLF

		AUU7RLF	AUU9RLF	AUU12RLF	AUU18RLF
Performance		HFI	HFI	HFI	HFI
Nominal Cooling	BTUh	7,000	9,000	12,000	18,000
Nominal Heating	BTUh	8,100	10,200	13,500	20,000
Fan					
Air Circulation: Hi	CFM (m3/h)	318 (540) Clg or Htg	318 (540) Clg or Htg	359 (610) Clg or Htg	441 (750) Clg 471 (800) Htg
Medium	CFM (m3/h)	288 (490) Clg or Htg	288 (490) Clg or Htg	312 (530) Clg or Htg	359 (610) Clg 418 (710) Htg
Low	CFM (m3/h)	259 (440) Clg or Htg	259 (440) Clg or Htg	277 (470) Clg or Htg	306 (520) Clg 353 (600) Htg
Quiet	CFM (m3/h)	230 (390) Clg or Htg	230 (390) Clg or Htg	241 (410) Clg or Htg	241 (410) Clg 265 (450) Htg
Fan Speed Stage		4+auto	4+auto	4+auto	4+auto
Sound					
Indoor Sound Level (Clg/Htg): Hi	dB(A)	33/34	33/34	37/37	42/44
Medium	dB(A)	31/32	31/32	33/33	37/40
Low	dB(A)	29/29	29/29	31/31	33/37
Quiet	dB(A)	27/27	27/27	28/28	29/30
Electrical					
Voltage/Frequency/Phase		208-230/60/1	208-230/60/1	208-230/60/1	208-230/60/1
Current Rated: Cooling	Amps	0.15	0.15	0.19	0.30
Current Rated: Heating	Amps	0.15	0.15	0.19	0.30
Input Power	W	18	18	23	39
Size & Weight					
Net Weight	lbs. (kg)	33 (15)	33 (15)	33 (15)	33 (15)
Dimensions: Height	Inch	9-11/16	9-11/16	9-11/16	9-11/16
	mm	245	245	245	245
Width	Inch	22-7/16	22-7/16	22-7/16	22-7/16
	mm	570	570	570	570
Depth	Inch	22-7/16	22-7/16	22-7/16	22-7/16
	mm	570	570	570	570
Refrigerant		R410A	R410A	R410A	R410A
Additional Data					
Air Direction: Vertical		Automatic			Automatic
Air Filter		Washable			Washable
Front Grille		UTG-CCGFG*			UTG-CCGFG*
Grille Dim: Height	Inch (mm)	1-15/16 (49)			1-15/16 (49)
Width	Inch (mm)	24-7/16 (620)			27-9/16 (700)
Depth	Inch (mm)	24-7/16 (620)			27-9/16 (700)
Lineset Size	Inch	suc 3/8		dis 1/4	suc 1/2 dis 1/4

* Compact Cassette Grille UTG-CCGFC sold separately. Must order one with each compact cassette.

9, 12, 15,000 BTU_h FLOOR MOUNT

MULTI-ZONE INDOOR



					<p>1 Applies when properly registered AND installed by a Fujitsu Elite Contractor in a residence. See full warranty for details. 2 Available with optional wired remote control. 3 Available only with optional Interface kit. Operation monitoring and On/Off control only.</p>								

2-FAN AND WIDE AIRFLOW

Having both upper and lower airflow quickly warms or cools the entire room. Floor mount can be set in "Upward Airflow Only" when occupants wish not to have feet warmed or cooled.

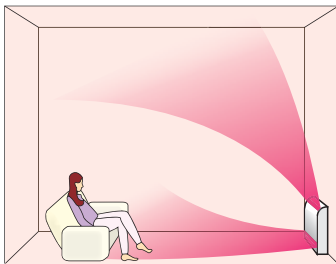

- | | |
|---|--|
| <p>1. Upon startup, both top and bottom louvers open.
 2. As the room temperature nears the setpoint, only the top louver stays open to help prevent cold air from falling.</p> | <p>1. Upon startup, both top and bottom louvers open.
 2. Closer to setpoint, only the top louver stays open to help prevent cold drafts from windows.</p> |
|---|--|

FLEXIBLE AND EASY INSTALLATION

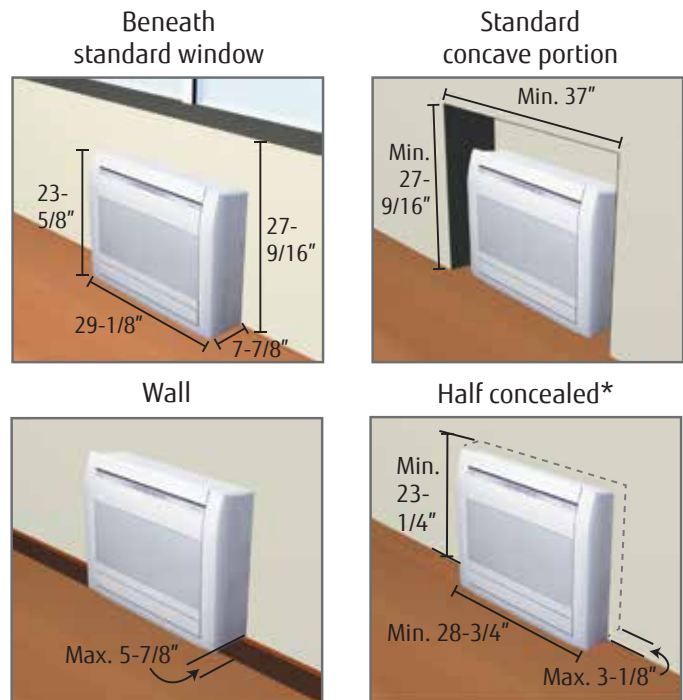

*Field supplied insulation required



HFI AGU9RLF, AGU12RLF, AGU15RLF

		AGU9RLF	AGU12RLF	AGU15RLF
Performance		HFI	HFI	HFI
Nominal Cooling	BTUh	9,000	12,000	14,200
Nominal Heating	BTUh	12,000	16,000	18,000
Fan				
Air Circulation: Hi	CFM (m3/h)	312 (530)	353 (600)	383 (650)
Medium	CFM (m3/h)	259 (440)	288 (490)	306 (520)
Low	CFM (m3/h)	212 (360)	224 (380)	235 (400)
Quiet	CFM (m3/h)	159 (270)	159 (270)	159 (270)
Fan Speed Stage		4+Auto	4+Auto	4+Auto
Sound				
Indoor Sound Level (Clg/Htg): Hi	dB(A)	39/39	42/42	44/44
Medium	dB(A)	34/34	36/38	38/39
Low	dB(A)	28/28	30/32	31/33
Quiet	dB(A)	22/22	22/22	22/22
Electrical				
Voltage/Frequency/Phase		208-230/60/1	208-230/60/1	208-230/60/1
Current Rated: Cooling	Amps	0.15	0.18	0.20
Current Rated: Heating	Amps	0.15	0.18	0.20
Input Power	W	16	18	23
Size & Weight				
Net Weight	lbs. (kg)	31 (14)	31 (14)	31 (14)
Dimensions: Height	Inch	23-5/8	23-5/8	23-5/8
	mm	600	600	600
Width	Inch	29-1/8	29-1/8	29-1/8
	mm	740	740	740
Depth	Inch	7-7/8	7-7/8	7-7/8
	mm	200	200	200
Refrigerant		R410A	R410A	R410A
Additional Data				
Air Direction: Horizontal		Manual	Manual	Manual
Air Direction: Vertical		Auto	Auto	Auto
Apple Catechin Filter		Washable	Washable	Washable
Ion Deodorizing Filter		Yes	Yes	Yes
Connection Method		Yes	Yes	Yes
Lineset Size	Inch	Suc. 3/8 Dis. 1/4	Suc. 3/8 Dis. 1/4	Suc. 1/2 Dis. 1/4



18, 24, 36, 45,000 BTUH MULTI-ZONE OUTDOOR UNITS

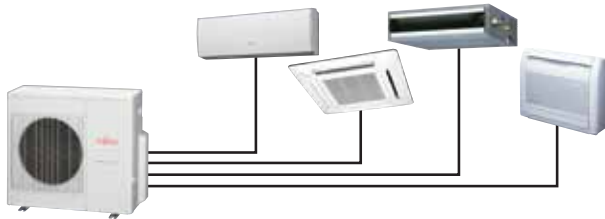

Outdoor unit

Contractors can select either an 18, 24, 36 or 45,000 BTUH outdoor unit combined with wall mounted, slim duct, compact cassette or floor mount type indoor units. Mix-and-match flexibility of evaporator type and capacity allows you to choose the indoor unit that best fits the application, whether it be hidden or showcased. These systems are ideal for nursing homes, doctor's offices, condominiums, apartments and residences - any place where individual cooling or heating is needed.

DC TWIN ROTARY COMPRESSOR

A high performance, low noise, large capacity DC twin rotary compressor is used.



COMPACT SIZE

The compact size of the outdoor units allows for many installation opportunities.

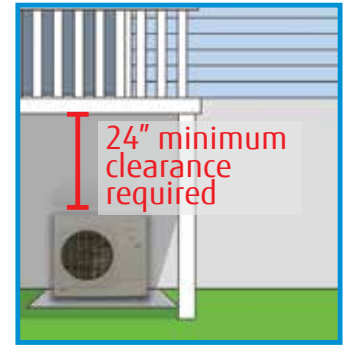
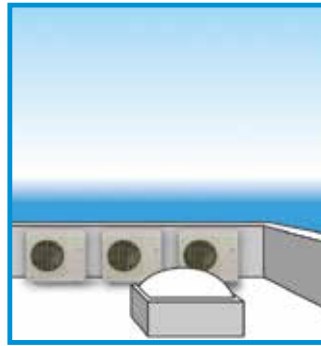
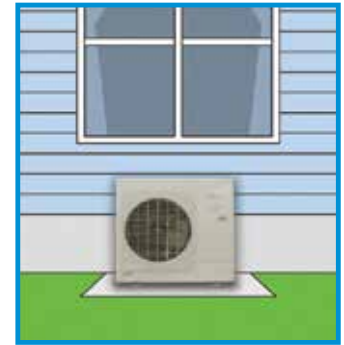
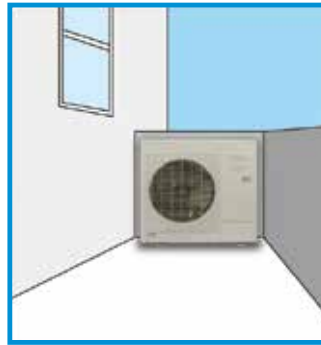

ENERGY STAR® QUALIFYING SYSTEMS:

OUTDOOR UNIT	INDOOR UNIT TYPE		
	Non-ducted	Ducted	Mixed
AOU18RLXFZ	★	--	--
AOU24RLXFZ	★	--	--
AOU36RLXFZ1	--	--	--
AOU45RLXFZ	--	--	--
AOU18RLXFZH	★	--	★
AOU24RLXFZH	★	--	★
AOU36RLXFZH	★	--	★

HFI AOU18RLXFZ, AOU24RLXFZ, AOU36RLXFZ1, AOU45RLXFZ

		AOU18RLXFZ ASU9+ASU9	AOU24RLXFZ ASU9+ASU7+ASU7	AOU36RLXFZ1 ASU9 x 4	AOU45RLXFZ ASU9 x 5
Performance		HFI	HFI	HFI	HFI
Connectable Indoor Units		2	2 to 3	2* to 4	2 to 5
Connectable Unit Capacity Class	BTUh	14 to 21,000 ¹	14 to 27,000 ¹	27 to 39,000 ¹	34 to 54,000
Rated Capacity Cooling / Heating	BTUh	18,000 / 22,000	22,000 / 24,000	35,200 / 36,400	45,000 / 48,000
Cooling Operating Range	°F (°C)	14~115 (-10~46)	14~115 (-10~46)	14~115 (-10~46)	14~115 (-10~46)
Heating Operating Range	°F (°C)	5~75 (-15~24)	5~75 (-15~24)	5~75 (-15~24)	5~75 (-15~24)
Electrical					
Rated Input Power Clg/Htg	kW	1.44/1.87	1.76/1.73	3.52/3.00	4.28/3.88
Voltage/Frequency/Phase		208-230/60/1	208-230/60/1	208-230/60/1	208-230/60/1
Maximum Total Current	Amps	10.0	13.7	20.3	23.8
Minimum Circuit Ampacity	Amps	12.1	16.7	24.6	28.9
Maximum Circuit Breaker	Amps	15	20	30	30
Fan: Type x Quantity		Propeller x 1	Propeller x 1	Propeller x 1	Propeller x 1
Sound Pressure Level Cooling	dB(A)	49	51	53	53
Sound Pressure Level Heating	dB(A)	49	52	55	55
Lineset Requirements					
Minimum Lineset Length Each	ft(m)	16 (5)	16 (5)	16 (5)	16 (5)
Maximum Lineset Length Each	ft(m)	82 (25)	82 (25)	82 (25)	82 (25)
Minimum Lineset Length Total	ft(m)	49 (15)	49 (15)	66 (20)	49 (15)
Maximum Lineset Length Total	ft(m)	164 (50)	164 (50)	230 (70)	264 (80)
Pre-Charge Length Total	ft(m)	98 (30)	98 (30)	164 (50)	164 (50)
Maximum Lineset Height Difference Btwn Outdoor Unit & Furthest Indoor Unit	ft(m)	49 (15)	49 (15)	49 (15)	49 (15)
Maximum Lineset Height Difference Btwn Indoor Units	ft(m)	33 (10)	33 (10)	33 (10)	33 (10)
Lineset Diameter	Inch	Liq. 1/4 x 2 Suc. 3/8 x 2	Liq. 1/4 x 3 Suc. 1/2 x 1, 3/8 x 2	Liq. 1/4 x 4 Suc. 1/2 x 1, 3/8 x 3	Liq. 1/4 x 5 Suc. 1/2 x 2, 3/8 x 3
Size & Weight					
Net Weight	lbs. (kg)	119 (54)	124 (56)	149 (68)	205 (93)
Dimensions: Height	Inch	27-9/16	27-9/16	32-11/16	39-5/16
	mm	700	700	830	998
Width	Inch	35-7/16	35-7/16	35-7/16	38-3/16
	mm	900	900	900	970
Depth	Inch	13	13	13	14-9/16
	mm	330	330	330	370
Refrigerant		R410A	R410A	R410A	R410A

*18+18 is the only 2 indoor unit (ASU, ARU or AOU) combination and requires K9FZ1818
¹See table for allowed combinations within this connectable capacity range.



Applies when properly registered AND installed by a Fujitsu Elite Contractor in a residence. See full warranty for details.

18, 24, 36,000 BTUh XLTH MULTI-ZONE OUTDOOR UNITS



HIGH PERFORMANCE HEATING

Fujitsu XLTH units feature large heat exchangers and high capacity compressors. This gives our XLTH heat pumps the ability to extract heat even at very low outdoor temperatures. Certain combinations will deliver up to 100% of their rated heating capacity down to 5°F. XLTH models are capable of heating down to -15°F outdoor temperatures.



XLTH
18, 24,000 BTUh



XLTH
36,000 BTUh

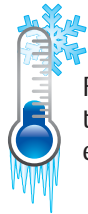

Fujitsu XLTH systems do not have a low temperature lockout, continuing to heat even below -15°F as conditions allow.

IMPROVED HEATING CAPACITY

Heating capacity at low outdoor temperatures was improved by adopting a large heat exchanger and a high capacity compressor.

AMBIENT HEATING TEMPERATURE OF -15°F

Other models may go as low as -5°F, however they do not include a base heater and other advancements found in XLTH models.

The base of Fujitsu's XLTH outdoor condensing units.

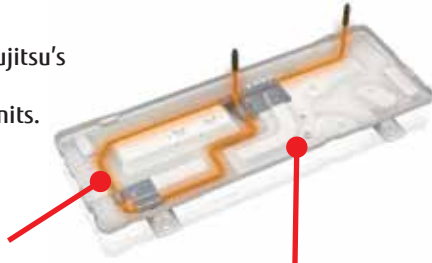

Base Heater

When temperatures reach 36°F, a built-in heater warms the base of the outdoor unit so that condensation doesn't freeze. Without a heater, freezing condensate can cause noise, damage to the fan blade, condenser, and system performance.

Base Drainage Holes

The contoured base design discharges melted water through many holes located at the bottom of the unit.

METAL FAN GUARD

While other models have a plastic fan guard, XLTH models use metal, which is more capable of withstanding the colder elements.



ENERGY STAR® QUALIFYING SYSTEMS:

OUTDOOR UNIT	INDOOR UNIT TYPE		
	Non-ducted	Ducted	Mixed
AOU18RLXFZ	★	--	--
AOU24RLXFZ	★	--	--
AOU36RLXFZ1	--	--	--
AOU45RLXFZ	--	--	--
AOU18RLXFZH	★	--	★
AOU24RLXFZH	★	--	★
AOU36RLXFZH	★	--	★

HIGH-HEAT AOU18RLXFZH, AOU24RLXFZH, AOU36RLXFZH

		AOU18RLXFZH	AOU24RLXFZH	AOU36RLXFZH
Performance		XLTH	XLTH	XLTH
Connectable Indoor Units		2	2 to 3	2 to 4
Connectable Unit Capacity Class	BTUh	14,000 to 21,000	14,000 to 27,000	27,000 to 39,000
Rated Capacity Cooling/Heating	BTUh	18,000/22,000	22,000/25,000	35,200/36,400
Cooling Operating Range	°F (°C)	14 to 115 (-10 to 46)	14~115 (-10~46)	14~115 (-10~46)
Heating Operating Range	°F (°C)	-15 to 75 (-26 to 24)	-15~75 (-26~24)	-15~75 (-26~24)
Electrical				
Rated Input Power Clg/Htg	kW	1.33/1.70	1.65/1.81	2.70/2.67
Voltage/Frequency/Phase		208-230/60/1	208-230/60/1	208-230/60/1
Maximum Total Current	Amps	16.4	20.8	26.0
Minimum Circuit Ampacity	Amps	19.7	25.1	31.5
Maximum Circuit Breaker	Amps	20	30	40
Fan: Type x Quantity		Propeller x 1	Propeller x 1	Propeller x 1
Sound Pressure Level Cooling	dB(A)	48	50	53
Sound Pressure Level Heating	dB(A)	50	52	55
Lineset Requirements				
Minimum Lineset Length Each	ft(m)	16 (5)	16 (5)	16 (5)
Maximum Lineset Length Each	ft(m)	82 (25)	82 (25)	82 (25)
Minimum Lineset Length Total	ft(m)	49 (15)	49 (15)	49 (15)
Maximum Lineset Length Total	ft(m)	164 (50)	230 (70)	230 (70)
Pre-Charge Length Total	ft(m)	98 (30)	98 (30)	164 (50)
Maximum Lineset Height Difference Btwn Outdoor Unit & Furthest Indoor Unit	ft(m)	49 (15)	49 (15)	49 (15)
Maximum Lineset Height Difference Btwn Indoor Units	ft(m)	33 (10)	33 (10)	33 (10)
Lineset Diameter	Inch	Liq. 1/4 x 2 Suc. 3/8 x 2	Liq. 1/4 x 3 Suc. 1/2 x 1, 3/8 x 2	Liq. 1/4 x 4 Suc. 1/2 x 1, 3/8 x 3
Size & Weight				
Net Weight	lbs. (kg)	134 (61)	146 (66)	205 (93)
Dimensions: Height	Inch	32-11/16	32-11/16	39-5/16
	mm	830	830	998
Width	Inch	35-7/16	35-7/16	38-3/16
	mm	900	900	970
Depth	Inch	13	13	14-9/16
	mm	330	330	370
Refrigerant		R410A	R410A	R410A



Applies when properly registered AND installed by a Fujitsu Elite Contractor in a residence. See full warranty for details.

48,000 BTU_h FLEX-ZONE OUTDOOR UNIT



A Hybrid system is the blending of a complex VRF system with the simplicity of a multi-zone system to create a hybrid solution that shares the best of both systems.

Flex provides the ability to create the right combinations, the right quantity (up to 8-zones), the right style indoor units, and the right capacity. It's the right choice for your home or business.

An Inverter is a system that controls the rotational speed (not just an ON/OFF signal) of an electric motor by adjusting the frequency and voltage of the electrical power supplied to the motor. The inverter constantly regulates the compressor speed to its optimum energy usage, producing higher refrigerant performance with less power consumption.

This system provides individual temperature control throughout your home or business so each room, zone or floor will be the temperature you set! An optional Central Remote Controller is available which can control up to all 8 indoor units from one keypad.

SELF DIAGNOSTIC FEATURE

This printed circuit board provides three modes of diagnostics - setting, monitoring and function mode, as well as error codes. It also provides a pre-commissioning check function. Setting mode allows optional functions to be selected. Monitoring mode provides temperature for each thermistor, compressor operation and other functions. Function mode provides cooling test run, heating test run and pump down operation.



COMPACT SIZE

The compact size of outdoor unit AOU48RLXFZ1 allows for many installation opportunities.

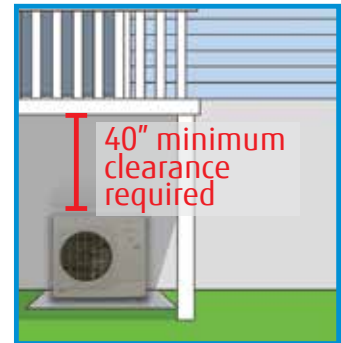
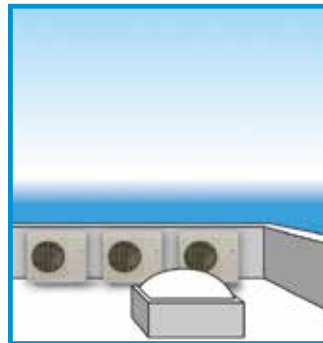
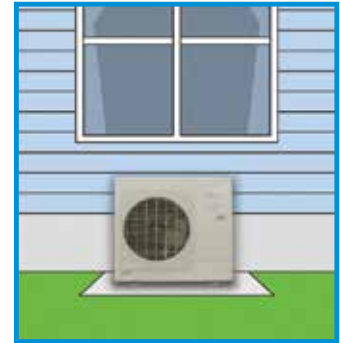
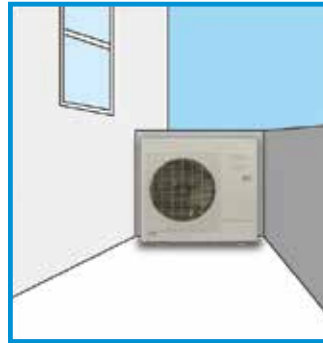

PIPING FLEXIBILITY

Contractors can choose the best direction for piping from the outdoor unit.

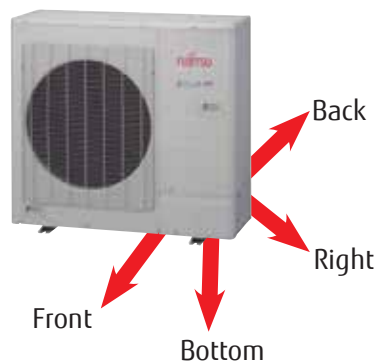

DC TWIN ROTARY COMPRESSOR

A high performance, low noise, large capacity DC twin rotary compressor is used. Includes Quiet Mode for night operation.



HFI AOU48RLXFZ1



AOU48RLXFZ1

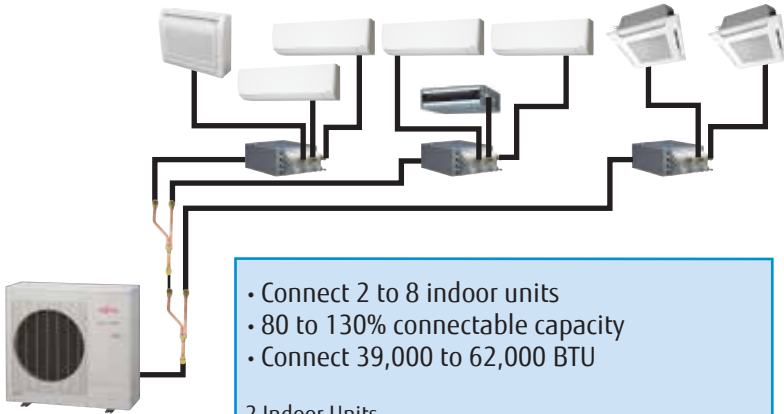

- Connect 2 to 8 indoor units
 - 80 to 130% connectable capacity
 - Connect 39,000 to 62,000 BTU
- 2 Indoor Units
 18k BTUh + 24 k BTUh = 42k BTUh --OK
 12k BTUh + 24 k BTUh = 36k BTUh --Not Allowed (below 80%)
- 8 Indoor Units
 7k BTUh x 8 units = 56k BTU --OK
 9k BTUh x 8 units = 72k BTU --Not Allowed (over 130%)

	SEER	HSPF	EER
Ducted	14.7	9.3	8.7
Non-Ducted	17.0	9.8	9.25
Mixed	15.8	9.5	8.97

Performance		HFI
Connectable Indoor Units		2 - 8
Connectable Unit Capacity Class	BTUh	80~130% Nominal (39,000~62,000)
Connectable Branch Boxes		1 - 3
Nominal Cooling	BTUh	48,000
Max Cooling	BTUh	51,100
Nominal Heating	BTUh	54,000
Low Temp. Heating 17°F	BTUh	40,000
Max Heating	BTUh	57,000
Cooling Operating Range	°F (°C)	23~115 (-5~46)
Heating Operating Range	°F (°C)	5~75 (-15~24)

Electrical		
Rated Input Power Cooling*	kW	5.52 / 5.19 / 5.35
Rated Input Power Heating*	kW	5.02 / 4.89 / 4.96
Voltage/Frequency/Phase		208-230/60/1
Maximum Current: Outdoor Cooling	Amps	24.5 / 23.0 / 23.7
Maximum Current: Outdoor Heating	Amps	22.3 / 21.7 / 22.0
Maximum Circuit Breaker	Amps	40
Fan: Type x Quantity		Propeller x 1
Fan Motor Output	W	111
Sound Pressure Level Cooling	dB(A)	56
Sound Pressure Level Heating	dB(A)	58

Lineset Requirements		
Maximum Lineset Length Total	ft(m)	377 (115)
Max. Pipe Length Between Box & Farthest Indoor Unit	ft(m)	49 (15)
Max. Pipe Height Difference Between Outdoor Unit & Branch Box)	ft(m)	98 (30)
Maximum Lineset Height Difference Btwn Outdoor Unit & Furthest Indoor Unit	ft(m)	98 (30)
Maximum Lineset Height Difference Btwn Indoor Units	ft(m)	49 (15)
Lineset Diameter	Inch	3/8 (Liq.) 5/8 (Suc.)

Size & Weight		
Net Weight	lbs. (kg)	216 (98)
Dimensions: Height	Inch	36
	mm	914
Width	Inch	38-1/4
	mm	970
Depth	Inch	14-5/8
	mm	370
Refrigerant		R410A

37*Ducted / Non-Ducted / Mixed



Applies when properly registered AND installed by a Fujitsu Elite Contractor in a residence. See full warranty for details.

BRANCH BOXES



UTP-PU03A, UTP-PU03B

	UTP-PU03A Primary	UTP-PU03B Secondary
Connectable Indoor Unit	1 ~ 3	1 ~ 3
Max. Combination BTUH	62,000 Nom.*	62,000 Nom.*
Min. Combination BTUH	7,000 Nom.*	7,000 Nom.*
Clg. Operating Range °F(°C)	25-115 (-5-46)	25-115 (-5-46)
Htg. Operating Range °F(°C)	5-75 (-15-24)	5-75 (-15-24)
%RH	80 or less	80 or less
Voltage/Frequency/Phase	208-230/60/1	208-230/60/1
Maximum Current Ampacity (A)	15	15
Running Current Rated (A): Cooling	0.050	0.050
Heating	0.050	0.050
Power Use Rated (W): Cooling	10	10
Heating	10	10

Dimensions: Gross (Flare to Flare):
 Height x Width x Depth Inch
 Height x Width x Depth mm
 Dimensions: Net (Metal Box Only):
 Height x Width x Depth Inch
 Height x Width x Depth mm
 Net Weight lbs. (kg)
 Conn. Pipe Diameter - Main Inch
 Conn. Pipe Diameter - Branch Inch
 Connection Method
 Connection Adapter Included Inch

	UTP-PU03A Primary	UTP-PU03B Secondary
Dimensions: Gross (Flare to Flare): Height x Width x Depth Inch	7-5/8 x 33 x 14-5/8	7-5/8 x 33 x 14-5/8
Height x Width x Depth mm	195 x 838 x 370	195 x 838 x 370
Dimensions: Net (Metal Box Only): Height x Width x Depth Inch	7-5/8 x 17 x 14-5/8	7-5/8 x 17 x 14-5/8
Height x Width x Depth mm	195 x 433 x 370	195 x 433 x 370
Net Weight lbs. (kg)	20 (9)	20 (9)
Conn. Pipe Diameter - Main Inch	(3/8 Liq. x 5/8 Suc.)	(3/8 Liq. x 5/8 Suc.)
Conn. Pipe Diameter - Branch Inch	(1/4 Liq. x 1/2 Suc.) 3 pair	(1/4 Liq. x 1/2 Suc.) 3 pair
Connection Method	Flare	Flare
Connection Adapter Included Inch	(1/2MF x 3/8FF) x 3 (1/2MF x 5/8FF) x 3 No adapter needed for 18k BTU	(1/2MF x 3/8FF) x 3 (1/2MF x 5/8FF) x 3 No adapter needed for 18k BTU

*As long as the total system nominal capacity is between 39,000 and 62,000 BTUH.

Warning: Branch boxes are not weather tight enclosures and cannot be mounted outdoors or in damp environments exceeding 80% relative humidity, unless using the Branch Box Outdoor Enclosure, Part #UTP-PX-A.

ALLOWED BRANCH BOX MOUNTING DIRECTION

Threaded Rod Mount



By reversing the electrical box position you can orient the inlet and outlet pipes into a left hand or right hand configuration.

Horizontal Wall Mount



By reversing the electrical box position you can orient the inlet and outlet pipes into a left hand or right hand configuration.

Vertical Wall Mount



You cannot reverse the electrical box position when mounting the branch box vertically.

BRANCH BOX OUTDOOR ENCLOSURE

UTP-PX-A

The Branch Box Outdoor Enclosure is used to mount the indoor style Branch Box outdoors. The Branch Box Outdoor Enclosure is a painted metal cover to match the condensing unit. When Branch Box Outdoor Enclosure is not required, see Installation Manual for indoor mounting instructions.

Allowed Mounting Positions

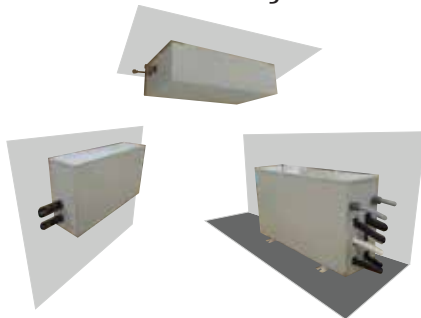

Dimensions in. (mm)	
Net (HxWxD)	8-11/16 x 32 x 17-7/8 (220 x 813 x 454)
Gross (HxWxD)	3-15/16 x 33-11/16 x 20-5/16 (100 x 880 x 515)
Weight lbs. (kg)	
Net Branch Box cover only	22 (10)
Net Branch Box + Cover	44.1 (20)
Gross	30.9 (14)



SEPARATION TUBE ASSEMBLY KIT

UTP-SX248A

Size	Liquid Inch	3/8 x 3/8 x 3/8
	Suction Inch	5/8 x 5/8 x 5/8

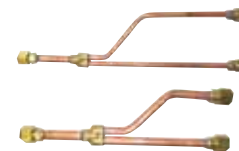

PIPING

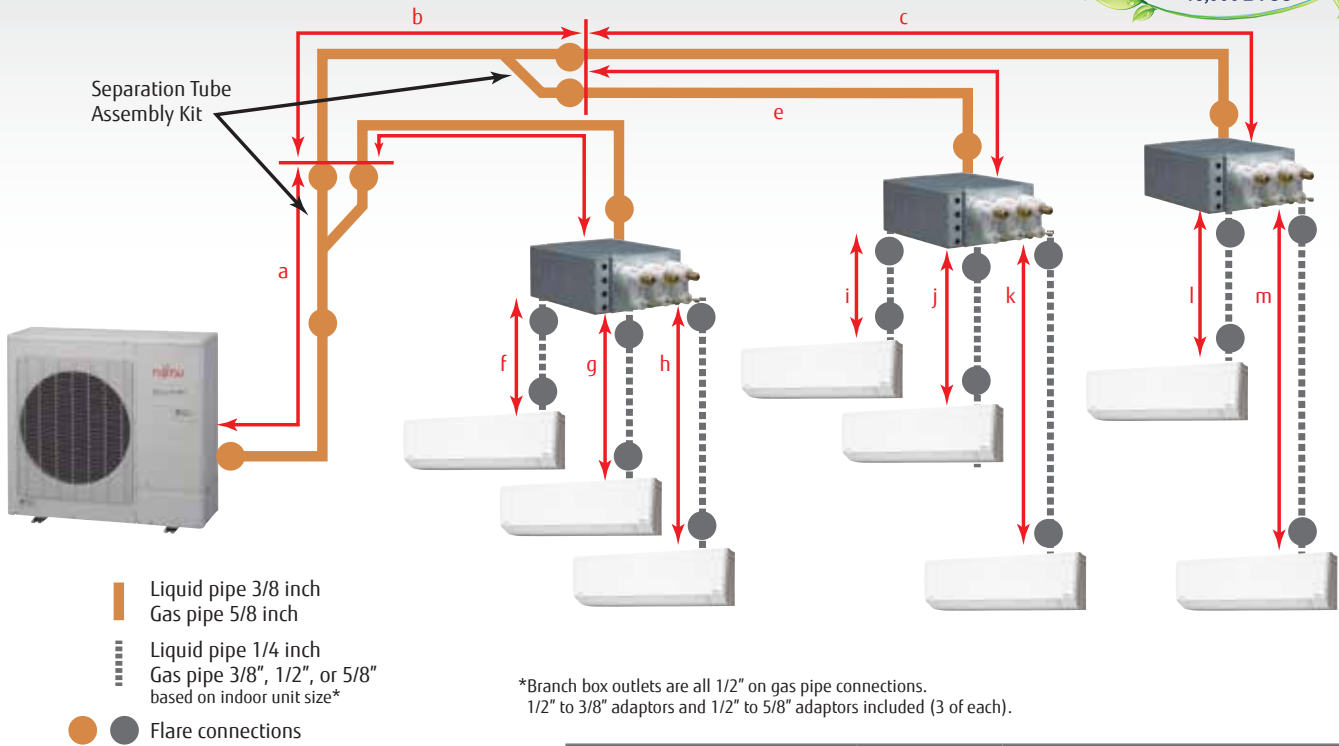

		Liquid pipe	Adaptor	Gas pipe
Branch Box to Indoor	7,000 BTUh	1/4"	included	3/8"
	9,000 BTUh		included	
	12,000 BTUh		included	
	18,000 BTUh		n/a	
	24,000 BTUh		included	
Calculate Refrigerant Charge Factory Charge 7.6 lb (3.45 kg) Unit pre-charged to 0 feet	Pipe Diameter	Location		Additional Refrig.
	3/8"	Outdoor to Branch Box		0.624 oz./ft. or 58g/meter
	1/4"	Branch Box to Indoor Unit		0.224 oz./ft. or 21g/meter
	(Total length of 3/8" liquid line × 0.624 oz./ft. or 58g/meter) + (Total length of 1/4" liquid line × 0.224 oz./ft. or 21g/meter) (a+b+c+d+e) × 0.624 oz./ft. or 58g/meter + (f+g+h+i+j+k+l+m) × 0.224 oz./ft. or 21g/meter = additional refrigerant			

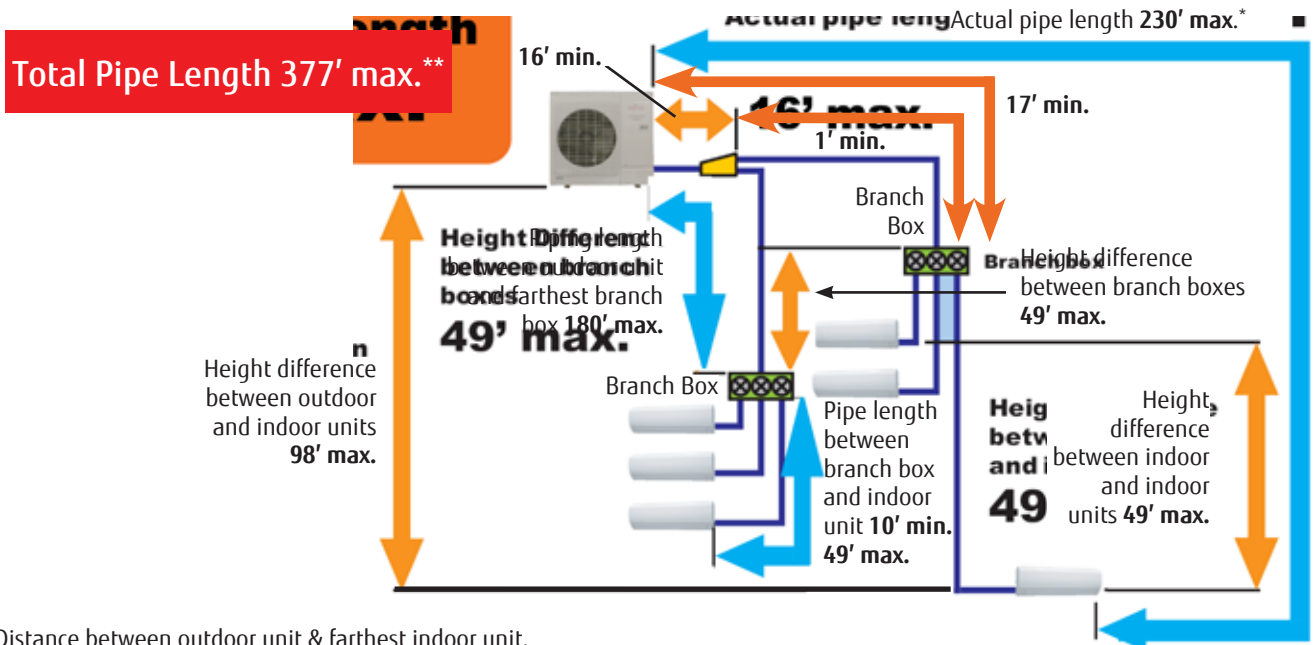

* Distance between outdoor unit & farthest indoor unit.
 ** Total liquid pipe or total gas pipe.

ALLOWABLE COMBINATIONS

Select either an 18, 24, 36, 45 or 48,000 BTU/h outdoor unit combined with wall mounted, slim duct, compact cassette or floor mount type indoor units. Mix-and-match flexibility of evaporator type and capacity allows you to choose the indoor unit that best fits the application, whether it be hidden or showcased.

CHOOSE AN OUTDOOR UNIT:



BTU/h Capacity	7,000	9,000	12,000	15,000	18,000	24,000
----------------	-------	-------	--------	--------	--------	--------

Outdoor Unit	Indoor Unit Config	7,000	9,000	12,000	15,000	18,000	24,000
AOU18RLXFZ / AOU18RLXFZH	2 INDOOR UNITS	7 7	7 7	12 -	30		
		7 9	7 9	15	33		
		7 12	7 12	18	36		
		9 9	9 9	12	33		
		9 12	9 12	15	36		
		9 18	9 18		39		
		12 12	12 12		36		
		12 15	12 15		39		
		12 18	12 18		36		
		15 15	15 15		33		
AOU24RLXFZ / AOU24RLXFZH	3 INDOOR UNITS MAX	7 7 -	7 7 -	12 -	14		
		7 9 -	7 9 -	15	16		
		7 12	7 12	18	19		
		7 15	7 15		22		
		7 18	7 18		25		
		9 9 -	9 9 -	12	18		
		9 12	9 12	15	21		
		9 15	9 15	18	24		
		9 18	9 18		27		
		12 12	12 12		24		
AOU36RLXFZ1 / AOU36RLXFZH	4 INDOOR UNITS MAX	7 7 7	7 7 7	12 12	21		
		7 7 9	7 7 9	15	23		
		7 7 12	7 7 12	18	26		
		7 7 15	7 7 15		25		
		7 7 18	7 7 18		27		
		9 9 9	9 9 9	12	26		
		9 9 12	9 9 12	15	25		
		9 9 15	9 9 15	18	25		
		9 9 18	9 9 18		27		
		12 12 12	12 12 12		27		
AOU45RLXFZ	2 INDOOR UNITS	18 18	18 18		36		
		7 24	7 24		31		
		9 24	9 24		33		
		12 24	12 24		36		
		15 24	15 24		39		
	3 INDOOR UNITS	7 7 24	7 7 24		38		
		7 9 18	7 9 18		34		
		7 9 24	7 9 24		40		
		7 12 18	7 12 18		37		
		7 12 24	7 12 24		43		
AOU36RLXFZ1 / AOU36RLXFZH	4 INDOOR UNITS MAX	18* 18*	18* 18*		36		
		7 7 15	7 7 15		29		
		7 7 18	7 7 18		32		
		7 7 24	7 7 24		38		
		7 9 12	7 9 12		28		
		7 9 15	7 9 15		31		
		7 9 18	7 9 18		34		
		7 12 12	7 12 12		31		
		7 12 15	7 12 15		34		
		7 12 18	7 12 18		37		

Actual rated cooling capacity of ASU15RLF1 is 14,000 BTU/h. * The optional kit "K9FZ1818 (UTP-MU36A2)" is necessary for dual zone system "18+18" with AOU36RLXFZ1 only. ^ Wall mounted type ASU18RLF cannot be connected in this combination using AOU36RLXFZ1. Combination allowed with AOU36RLXFZH. "*" represents available circuit for future expansion when connecting this combination.

ALLOWABLE COMBINATIONS CONT'D.

CHOOSE INDOOR UNITS:



ASU7RLF1
ASU9RLF1
ASU12RLF1
ASU15RLF1
ASU18RLF
ASU24RLF



ARU7RLF
ARU9RLF
ARU12RLF
ARU18RLF
ARU24RLF



AAU7RLF
AAU9RLF
AAU12RLF
AAU18RLF



AGU9RLF
AGU12RLF
AGU15RLF

 = Allowed "Connectable Capacity" combinations over 100%

						AOU48RLXFZ1											
2 INDOOR UNITS MAX						7	7	7	9	15	45	18	24		42		
						7	7	7	9	18	48	24	24		48		
3 INDOOR UNITS MAX						7	7	7	12	12	45	7	9	24		40	
						7	7	7	12	15	48	7	12	24		43	
						7	7	7	12	18	51	7	15	18		40	
						7	7	7	15	15	51	7	15	24		46	
						7	7	7	15	18	54	7	18	18		43	
						7	7	9	9	9	41	7	18	24		49	
						7	7	9	9	12	44	7	24	24		55	
						7	7	9	9	15	47	9	9	24		42	
						7	7	9	9	18	50	9	12	18		39	
						7	7	9	12	12	47	9	12	24		45	
						7	7	9	12	15	50	9	15	18		42	
						7	7	9	12	18	53	9	15	24		48	
						7	7	9	15	15	53	9	18	18		45	
						7	7	12	12	12	50	9	18	24		51	
						4 INDOOR UNITS MAX						7	7	12	12	15	53
7	9	9	9	9	43							12	12	18		42	
7	9	9	9	12	46							12	12	24		48	
7	9	9	9	15	49							12	15	15		42	
7	9	9	9	18	52							12	15	18		45	
7	9	9	12	12	49							12	15	24		51	
7	9	9	12	15	52							12	18	18		48	
7	9	12	12	12	52							12	18	24		54	
9	9	9	9	9	45							12	24	24		60	
9	9	9	9	12	48							15	15	15		45	
9	9	9	9	15	51							15	15	18		48	
9	9	9	9	18	54							15	15	24		54	
9	9	9	12	12	51							15	18	18		51	
9	9	9	12	15	54							15	18	24		57	
9	9	12	12	12	54							15	24	24		63	
18	18	18			54	18	18	18		54							
18	18	24			60	18	18	24		60							
5 INDOOR UNITS MAX						7	7	7	18		39	7	7	7	18		39
						7	7	7	24		45	7	7	7	15		43
						7	7	9	18		41	7	7	7	18		46
						7	7	9	24		47	7	7	7	24		52
						7	7	12	15		41	7	7	7	9	9	39
						7	7	12	18		44	7	7	7	9	12	42
						7	7	12	24		50	7	7	7	9	15	45
						7	7	15	15		44	7	7	7	9	18	48
						7	7	15	18		47	7	7	7	9	24	54
						7	7	15	24		53	7	7	7	9	12	45
						7	7	15	18		47	7	7	7	12	12	45
						7	7	15	24		53	7	7	7	12	15	48
						7	7	15	18		47	7	7	7	12	24	57
						7	7	15	24		53	7	7	7	15	15	51

ALLOWABLE COMBINATIONS CONT'D



BTUH Capacity 7,000 9,000 12,000 15,000 18,000 24,000

 = Allowed "Connectable Capacity" combinations over 100%

AOU48RLXFZ1, con't.

5 INDOOR UNITS MAX	7	7	9	9	24	56
	7	7	9	12	12	47
	7	7	9	12	15	50
	7	7	9	12	18	53
	7	7	9	12	24	59
	7	7	9	15	15	53
	7	7	9	15	18	56
	7	7	9	15	24	62
	7	7	9	18	18	59
	7	7	12	12	12	50
	7	7	12	12	15	53
	7	7	12	12	18	56
	7	7	12	12	24	62
	7	7	12	15	15	56
	7	7	12	15	18	59
	7	7	12	18	18	62
	7	7	15	15	15	59
	7	7	15	15	18	62
	7	9	9	9	9	43
	7	9	9	9	12	46
	7	9	9	9	15	49
	7	9	9	9	18	52
	7	9	9	9	24	58
	7	9	9	12	12	49
	7	9	9	12	15	52
	7	9	9	12	18	55
	7	9	9	12	24	61
	7	9	9	15	15	55
7	9	9	15	18	58	
7	9	9	18	18	61	
7	9	12	12	12	52	
7	9	12	12	15	55	
7	9	12	12	18	58	
7	9	12	15	15	58	
7	9	12	15	18	61	
7	9	15	15	15	61	
7	9	15	15	18	64	

5 INDOOR UNITS MAX	7	12	12	12	12	55
	7	12	12	12	15	58
	7	12	12	12	18	61
	7	12	12	15	15	61
	7	12	15	15	15	64
	9	9	9	9	9	45
	9	9	9	9	12	48
	9	9	9	9	15	51
	9	9	9	9	18	54
	9	9	9	9	24	60
	9	9	9	12	12	51
	9	9	9	12	15	54
	9	9	9	12	18	57
	9	9	9	15	15	57
	9	9	9	15	18	60
	9	9	12	12	12	54
	9	9	12	12	15	57
	9	9	12	12	18	60
	9	9	12	15	15	60
	9	9	12	15	18	63
	9	9	12	15	15	63
	9	12	12	12	12	57
	9	12	12	12	15	60
	12	12	12	12	12	60
	12	12	12	12	15	63

6 INDOOR UNITS MAX	7	7	7	7	7	42
	7	7	7	7	9	44
	7	7	7	7	12	47
	7	7	7	7	15	50
	7	7	7	7	18	53
	7	7	7	7	24	59
	7	7	7	7	9	46
	7	7	7	7	9	49
	7	7	7	7	9	52
	7	7	7	7	9	55
	7	7	7	7	9	61
	7	7	7	7	9	61

6 INDOOR UNITS MAX	7	7	7	7	12	12	52
	7	7	7	7	12	15	55
	7	7	7	7	12	18	58
	7	7	7	7	15	15	58
	7	7	7	7	15	18	61
	7	7	7	9	9	9	48
	7	7	7	9	9	12	51
	7	7	7	9	9	15	54
	7	7	7	9	9	18	57
	7	7	7	9	12	12	54
	7	7	7	9	12	15	57
	7	7	7	9	12	18	60
	7	7	7	9	15	15	60
	7	7	7	9	15	18	63
	7	7	7	12	12	12	57
	7	7	7	12	12	15	60
	7	7	7	12	15	15	63
	7	7	9	9	9	9	50
	7	7	9	9	9	12	53
	7	7	9	9	9	15	56
	7	7	9	9	9	18	59
	7	7	9	9	12	12	56
	7	7	9	9	12	15	59
	7	7	9	9	12	18	62
	7	7	9	9	15	15	62
	7	7	9	9	15	15	62
	7	7	9	9	15	18	65
	7	7	9	9	18	12	61

6 INDOOR UNITS MAX	9	9	9	9	9	9	54
	9	9	9	9	9	12	57
	9	9	9	9	9	15	60
	9	9	9	9	12	12	60
	9	9	9	9	12	15	63

7 INDOOR UNITS MAX	7	7	7	7	7	7	49
	7	7	7	7	7	9	51
	7	7	7	7	7	12	54
	7	7	7	7	7	15	57
	7	7	7	7	7	18	60
	7	7	7	7	9	9	53
	7	7	7	7	9	12	56
	7	7	7	7	9	15	59
	7	7	7	7	9	18	62
	7	7	7	7	9	12	59
	7	7	7	7	12	15	62
	7	7	7	7	9	9	55
	7	7	7	7	9	9	58
	7	7	7	7	9	15	61
	7	7	7	7	9	12	61
	7	7	7	9	9	9	57
	7	7	7	9	9	12	60
	7	7	7	9	9	15	63

8 INDOOR UNITS MAX	7	7	7	7	7	7	56
	7	7	7	7	7	9	58
	7	7	7	7	7	12	61
	7	7	7	7	7	9	60
	7	7	7	7	9	9	62
	7	7	7	7	9	9	62

ACCESSORY COMPATIBILITY

		HFI MULTI-ZONE AND FLEX-ZONE SYSTEMS						
		Small Wall (RLF1 - 7, 9, 12, 15k BTUh)	Large Wall (RLF 18, 24k BTUh)	Cassette	Slim Duct	Floor Mount	AOU45RLXFZ	AOU48RLXFZ1
REMOTE CONTROLS								
UTY-RNNUM	Wired Remote Control	● ¹	●	●	●	●		
UTY-RVNUM	Wired Remote Control (Backlit)	● ¹	● ²	● ²	● ²	● ²		
UTY-RSNUM	Simple Remote Control 3-Wire	● ¹	●	●	●	●		
UTY-LNHUM	Wireless Remote Control			●				
UTY-DMMUM	Central Remote Control						●	●
UTY-XSZX	Remote Sensor				●			
UTY-LRHUM	Receiver Unit				●			
WI-FI DEVICES								
FJ-IR-WIFI-1NA	Wi-Fi Device: IR Wireless Module	●	●	●	●	●		
FJ-RC-WIFI-1NA	Wi-Fi Device: Wired Module	●*	●	●	●	●		
UTY-TFNXZ2	Wi-Fi Module	● ¹	●	●	●	●		
UTY-WIFI	Wi-Fi Plug	● ³	● ³					
INTERFACE KITS								
UTY-XWZX	Dry Contact Wire Kit		●	●				
UTY-XWZXZ5	Dry Contact Wire Kit	● ¹				●		
UTY-XCBXZ2	Interface Kit ³	●						
UTD-ECSSA	Slim Duct Connector Kit				●			
UTY-XWZXZ3	Outdoor Unit Input/Output Connector							●
UTY-XWZXZ4	Outdoor Unit Base Heater Connector							●
FRESH AIR INTAKE KITS								
UTZ-KXGC	High Humidity Insulation Kit			●				
UTR-YDZB	Air Outlet Shutter Plate			●				
UTZ-VXAA	Fresh Air Intake Kit			●				
MISCELLANEOUS								
UTY-TTRX	Thermostat Converter	●	●	●	●	●		
UTY-VTGX	Network Converter	●	●	●	●	●		
K3PST	3-Pole Single Throw Safety Switch	●	●	●	●	●		
K9R410A55	R410A Swivel Adapter	●	●	●	●	●		
K9FZ1818	18+18 Combo Fittings Kit (for AOU36RLXFZ1)		●					
UTD-GXSA-W	Auto Louver Grille Kit (for ARU9, 12)				●			
UTD-GXSB-W	Auto Louver Grille Kit (for ARU18)				●			
UTD-GXSC-W	Auto Louver Grille Kit (for ARU24)				●			

¹ Wall mounted ASU7, 9, and 12RLF1 require accessory interface kit #UTY-XCBXZ2 in order to connect these devices to them.
² Only multi-zone models greater than specific serial numbers are compatible with UTY-RVNUM. See Service Bulletin 0031 for serial number compatibility.
³ UTY-WIFI required to connect Small and Large Wall Mounts to FJ-RC-WIFI-1NA and UTY-TFNXZ2.
 * Requires accessory interface kit #UTY-XCBXZ2 and plug model #UTY-WIFI in order to connect these devices to them.

WI-FI AND WIRELESS OPTIONS See below for compatible systems.

WI-FI MODULE - UTY-TFNXZ2 - Add wireless capability to your Fujitsu system through FGLair. Cannot be installed in conjunction with Wired Remote Controls.

IR WIRELESS MODULE - FJ-IR-WIFI-1NA

WIRED MODULE - FJ-RC-WIFI-1NA
 The IR Wireless and Wired Modules work with the IntesisHome® app.

THIRD PARTY THERMOSTAT CONVERTER - UTY-TTRX
 Control your Fujitsu heating and cooling system with your favorite smart thermostat (not included).



AMAZON ECHO ALEXA SKILL - Voice control for your Fujitsu Halcyon system using Amazon Echo. With FGLair, there is no loss of inverter efficiency.



Compatibility:

- WALL MOUNTS** ASU 7 / 9 / 12 / 15RLF1 (WI-FI MODULE / FGLair app requires UTY-XCBXZ2. WIRED MODULE / Intesis Home app requires UTY-WIFI and UTY-XCBXZ2)
 ASU 18 / 24RLF
- CASSETTES** AUU 7 / 9 / 12 / 18RLF
- DUCTED** ARU 7 / 9 / 12 / 18 / 24RLF (IR WIRELESS MODULE / Intesis Home app requires UTY-LRHUM)
- FLOOR MOUNTS** AGU 9 / 12 / 15RLF. (IR WIRELESS MODULE / Intesis Home app requires UTY-LRHUM. WIRED MODULE / Intesis Home app requires UTY-WIFI)

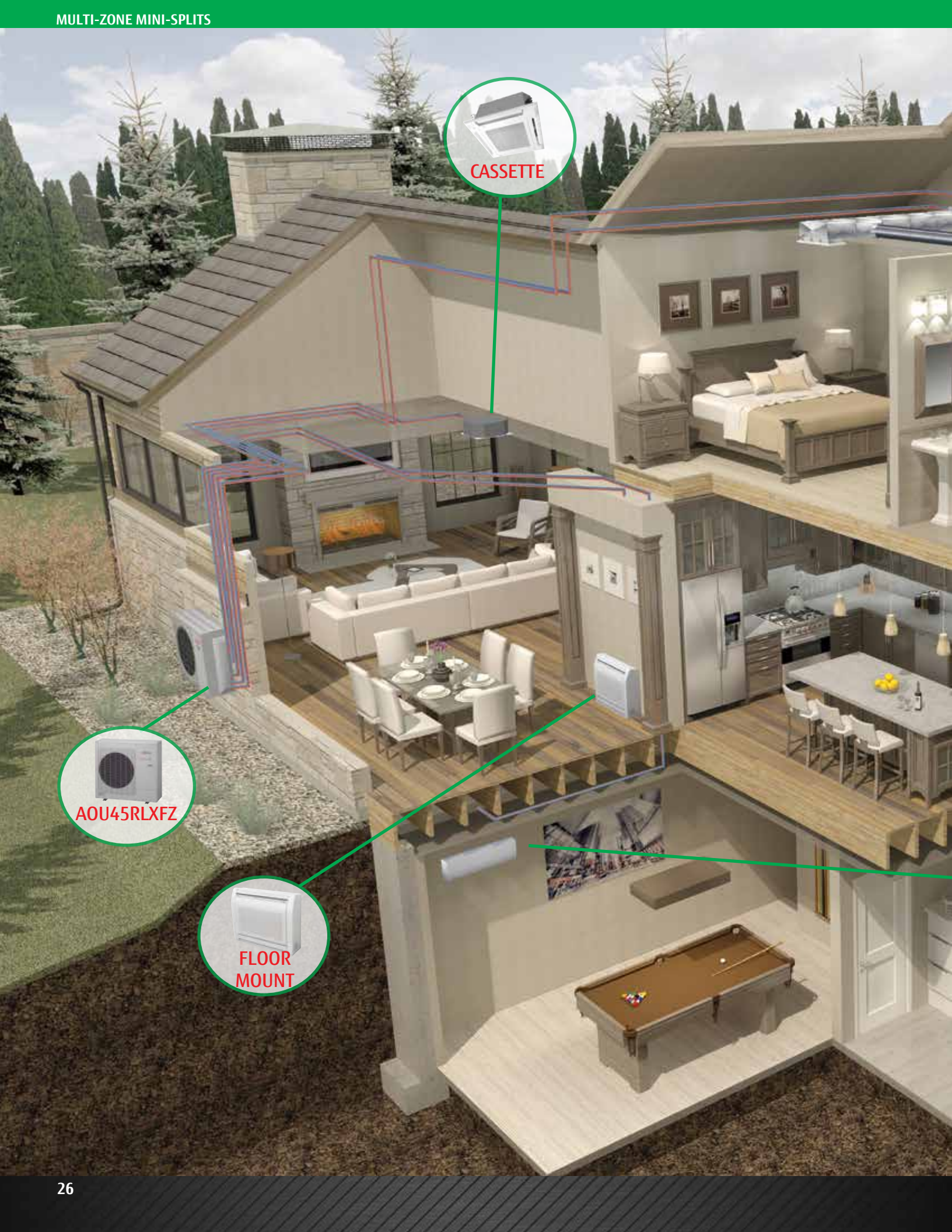

CASSETTE



AOU45RLXFZ



FLOOR MOUNT



SLIM DUCT



WALL MOUNT

WHOLE HOME SOLUTIONS

18, 24, 36, 45,000 BTUh outdoor heat pumps

- Connect 2 to 5 indoor units
- 58 to 120% connectable capacity
- Connect 14,000 to 54,000 BTUh

Cool or heat one room, a few rooms or an entire home.



WALL MOUNT



WHERE CAN MINI-SPLITS BE USED?

- Bars
- Oil rigs
- Schools
- Car washes
- Warehouses
- Nursing homes
- Small offices
- Older homes
- Restaurants
- Computer rooms
- Hotels and motels
- ATM vestibules
- Convenience stores
- Fast food chains
- Fire houses
- Police stations
- Sunrooms
- New construction
- Places of worship
- Medical facilities

JUST ABOUT ANY PLACE THAT REQUIRES COMFORT!

FUJITSU

INFINITE COMFORT

Fujitsu General America, Inc.
 353 Route 46 West
 Fairfield, NJ 07004
 Toll Free: (888) 888-3424
 Local: (973) 575-0380
 Fax: (973) 836-0447
 Email: hvac@fujitsugeneral.com
www.fujitsugeneral.com

Halcyon is worldwide trademark of FUJITSU GENERAL LIMITED and is a registered trademark of Japan, the USA, and other countries or areas.

FGLair is worldwide trademark of FUJITSU GENERAL LIMITED.

Part #6-26-FG2057 Rev. 6/2019

