

TECHNICAL MANUAL

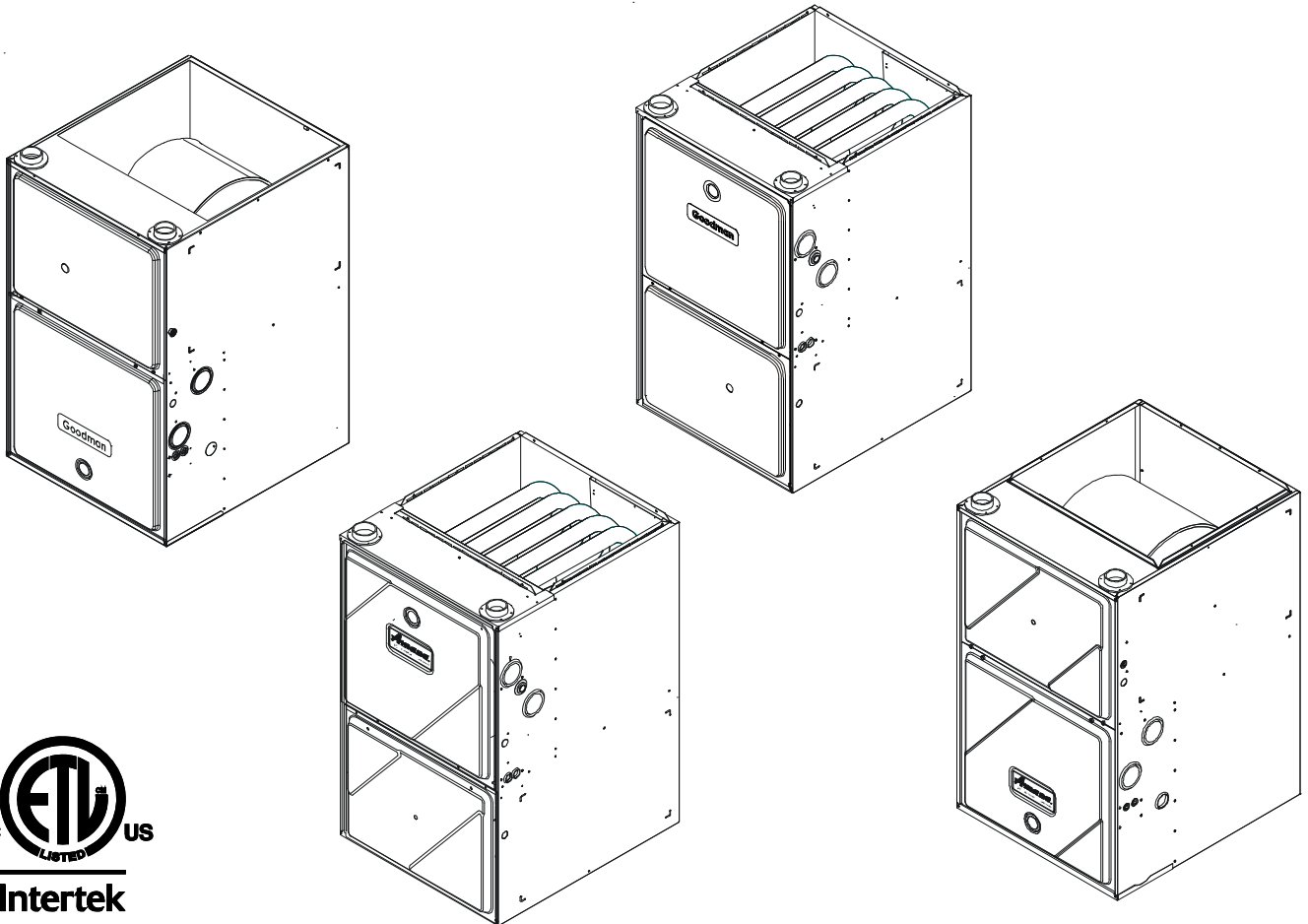

*CVC97/*MVC97 97% Gas Furnace Units

- Refer to Service Manual RS6612009 for installation, operation, and troubleshooting information.
- Refer to the appropriate Parts Catalog for part number information.
- Models listed on page 3.



This manual is to be used by qualified, professionally trained HVAC technicians only. Goodman does not assume any responsibility for property damage or personal injury due to improper service procedures performed by an unqualified person.

RT6612031
September 2014

PRODUCT IDENTIFICATION

The model and manufacturing number are used for positive identification of component parts used in manufacturing. Please use these numbers when requesting service or parts information.

	*	M	V	C	9	7	0	6	0	3	B	N	A	A
	1	2	3	4	5	6	7	8	9	10	11	12	13	14
Brand	G - Goodman® Brand A - Amana® Brand													Minor Revision A - Initial Release B - 1st Revision
Configuration	M - Upflow/Horizontal C - Downflow/Horizontal K - Dedicated Upflow D - Dedicated Downflow													Major Revision A - Initial Release B - 1st Revision
Motor	V - Variable Speed ECM /ComfortNet E - Multi-Speed ECM S - Single Speed													NOx N - Low Nox
Gas Valve	M - Modulating V - 2 Stage H - Convertible 2 Stage S - Single Stage													Cabinet Width A - 14" B - 17.5" C - 21" D - 24.5"
AFUE	97 - 97% AFUE													Maximum CFM 2 - 800 CFM 3 - 1200 CFM 4 - 1600 CFM 5 - 2000 CFM
MBTU/h	040 - 40,000 060 - 60,000 080 - 80,000 100 - 100,000 120 - 120,000													

WARNING

HIGH VOLTAGE!

Disconnect ALL power before servicing or installing this unit. Multiple power sources may be present. Failure to do so may cause property damage, personal injury or death.

WARNING

Goodman will not be responsible for any injury or property damage arising from improper service or service procedures. If you install or perform service on this unit, you assume responsibility for any personal injury or property damage which may result. Many jurisdictions require a license to install or service heating and air conditioning equipment.





WARNING

Installation and repair of this unit should be performed ONLY by individuals meeting the requirements of an "entry level technician", at a minimum, as specified by the Air-Conditioning, Heating, and Refrigeration Institute (AHRI). Attempting to install or repair this unit without such background may result in product damage, personal injury or death.

PRODUCT IDENTIFICATION

The model and manufacturing number are used for positive identification of component parts used in manufacturing. Please use these numbers when requesting service or parts information.

- *CVM970603BNA*
- *CVM970803BNA*
- *CVM970804CNA*
- *CVM971005CNA*
- *MVM970603BNA*
- *MVM970803BNA*
- *MVM970804CNA*
- *MVM971005CNA*
- *MVM971205DNA*

 DANGER

CARBON MONOXIDE POISONING HAZARD Special warning for installation of furnaces or air handling units in enclosed areas such as garages, utility rooms or parking areas. Carbon monoxide producing devices (such as automobiles, space heaters, gas water heaters, etc.) should not be operated in enclosed areas such as unventilated garages or utility rooms because of the danger of carbon monoxide (CO) poisoning resulting from the exhaust emissions. If a furnace or air handler is installed in an enclosed area and a carbon monoxide producing device is operated therein, there must be adequate direct outside ventilation. Carbon monoxide emissions can be (re)circulated throughout the structure if the furnace or air handler is operating in any mode. CO can cause serious illness including permanent brain damage or death.
 DANGER
RISQUE D'EMPOISONNEMENT AU MONOXYDE DE CARBONE Avertissement special au sujet de l'installation d'appareils de chauffage ou de traitement d'air dans des endroits clos, tels les garages, les locaux d'entretien et les Stationnements. Evitez de mettre en marche les appareils produisant du monoxyde de carbone (tels que les automobile, les appareils de chauffage autonome, etc.) dans des endroits non ventilés tels que les d'empoisonnement au monoxyde de carbone. Si vous devez faire fonctionner ces appareils dans un endroit clos, assurez-vous qu'il y ait une ventilation directe provenant de l'exterieur. Les émissions de monoxyde de carbone peuvent être recirculées dans les endroits clos, si l'appareil de chauffage ou de traitement d'air sont en marche. Le monoxyde de carbone peut causer des maladies graves telles que des dommages permanents au cerveau et même la mort.
 PELIGRO
RIESGO DE INTOXICACIÓN POR MONÓXIDO DE CARBONO Advertencia especial para la instalación de calentadores ó manejadoras de aire en áreas cerradas como estacionamientos ó cuartos de servicio. Los equipos ó aparatos que producen monóxido de carbono (tal como automóvil, calentador de gas, calentador de agua por medio de gas, etc) no deben ser operados en áreas cerradas debido al riesgo de envenenamiento por monóxido de carbono (CO) que resulta de las emisiones de gases de combustión. Si el equipo ó aparato se opera en dichas áreas, debe existir una adecuada ventilación directa al exterior. Las emisiones de monóxido de carbono pueden circular a través del aparato cuando se opera en cualquier modo. El monóxido de carbono puede causar enfermedades severas como daño cerebral permanente ó muerte.
<small>0140M00020-D</small>

 WARNING	The United States Environmental Protection Agency ("EPA") has issued various regulations regarding the introduction and disposal of refrigerants introduced into this unit. Failure to follow these regulations may harm the environment and can lead to the imposition of substantial fines. These regulations may vary by jurisdiction. Should questions arise, contact your local EPA office.
--	--

 WARNING	Do not connect or use any device that is not design certified by Goodman for use with this unit. Serious property damage, personal injury, reduced unit performance and/or hazardous conditions may result from the use of such non-approved devices.
--	---

 WARNING	To prevent the risk of property damage, personal injury, or death, do not store combustible materials or use gasoline or other flammable liquids or vapors in the vicinity of this appliance.
--	---

FURNACE SPECIFICATIONS

	*MVM97 0603BNA	*MVM97 0803BNA	*MVM97 0804CNA	*MVM97 1005CNA	*MVM97 1205DNA
Heating Data					
High Fire Input ¹	60,000	80,000	80,000	100,000	120,000
High Fire Output ¹	58,200	77,600	77,600	97,000	116,400
Low-Fire Steady-State Input ¹	30,000	40,000	40,000	50,000	60,000
Low-Fire Steady-State Output ¹	29,100	38,800	38,800	48,500	58,200
AFUE ²	97	97	97	97	97
Temperature Rise Range (°F)	20 - 50	30 - 60	25 - 55	35 - 65	35 - 65
Vent Diameter ³	2" - 3"	2" - 3"	2" - 3"	2" - 3"	2" - 3"
No. of Burners	3	4	4	5	6
Circulator Blower					
Available AC @ 0.5" ESP	1.5 - 3	1.5 - 3	1.5 - 4	41,675	41,675
Size (D x W)	11" x 8"	11" x 8"	11" x 10"	11" x 10"	11" x 11"
Horsepower @ 1075 RPM	1/2	1/2	3/4	1	1
Speed	VS ECM	VS ECM	VS ECM	VS ECM	VS ECM
Filter Size (in²)					
Permanent	739	766	862	862	1035
Disposable	370	383	431	431	517
Electrical Data					
Min. Circuit Ampacity ⁴	8.8	8.8	11.6	15.4	15.4
Max. Overcurrent Device (amps) ⁵	15	15	15	20	20
Shipping Weight (lbs)					
	118	121	142	144	157

¹ Natural Gas BTU/h

² DOE AFUE based upon Isolated Combustion System (ICS)

³ Installer must supply one or two PVC pipes: one for combustion air (optional) and one for the flue outlet (required). Vent pipe must be either 2" or 3" in diameter, depending upon furnace input, number of elbows, length of run and installation (1 or 2 pipes). The optional Combustion Air Pipe is dependent on installation/code requirements and must be 2" or 3" diameter PVC.

⁴ Minimum Circuit Ampacity = (1.25 x Circulator Blower Amps) + ID Blower amps. Wire size should be determined in accordance with National Electrical Codes. Extensive wire runs will require larger wire sizes.

⁵ Maximum Overcurrent Protection Device refers to maximum recommended fuse or circuit breaker size. May use fuses or HACR-type circuit breakers of the same size as noted.

Notes

- All furnaces are manufactured for use on 115 VAC, 60 Hz, single-phase electrical supply.
- Gas Service Connection ½" FPT
- Important: Size fuses and wires properly and make electrical connections in accordance with the National Electrical Code and/or all existing local codes.
- For bottom return: Failure to unfold flanges may reduce airflow by up to 18%. This could result in performance and noise issues.
- For servicing or cleaning, a 24" front clearance is required. Unit connections (electrical, flue and drain) may necessitate greater clearances than the minimum clearances listed above. In all cases, accessibility clearance must take precedence over clearances from the enclosure where accessibility clearances are greater.

FURNACE SPECIFICATIONS

	*CVM97 0603BNA	*CVM97 0803BNA	*CVM97 0804CNA	*CVM97 1005CNA
Heating Data				
High Fire Input ¹	60,000	80,000	80,000	100,000
High Fire Output ¹	58,200	77,600	77,600	97,000
Low-Fire Steady-State Input ¹	30,000	40,000	40,000	50,000
Low-Fire Steady-State Output ¹	29,100	38,800	38,800	48,500
AFUE ²	97	97	97	97
Temperature Rise Range (°F)	20 - 50	30 - 60	25 - 55	35 - 65
Vent Diameter ³	2" - 3"	2" - 3"	2" - 3"	2" - 3"
No. of Burners	3	4	4	5
Circulator Blower				
Available AC @ 0.5" ESP	1.5 - 3	1.5 - 3	1.5 - 4	41,675
Size (D x W)	11" x 8"	11" x 8"	11" x 10"	11" x 10"
Horsepower @ 1075 RPM	1/2	1/2	3/4	1
Speed	VS ECM	VS ECM	VS ECM	VS ECM
Filter Size (in²)				
Permanent	517	690	690	862
Disposable	259	345	345	431
Electrical Data				
Min. Circuit Ampacity ⁴	8.8	8.8	11.6	15.4
Max. Overcurrent Device (amps) ⁵	15	15	15	20
Shipping Weight (lbs)				
	117	122	144	146

¹ Natural Gas BTU/h

² DOE AFUE based upon Isolated Combustion System (ICS)

³ Installer must supply one or two PVC pipes: one for combustion air (optional) and one for the flue outlet (required). Vent pipe must be either 2" or 3" in diameter, depending upon furnace input, number of elbows, length of run and installation (1 or 2 pipes). The optional Combustion Air Pipe is dependent on installation/code requirements and must be 2" or 3" diameter PVC.

⁴ Minimum Circuit Ampacity = (1.25 x Circulator Blower Amps) + ID Blower amps. Wire size should be determined in accordance with National Electrical Codes. Extensive wire runs will require larger wire sizes.

⁵ Maximum Overcurrent Protection Device refers to maximum recommended fuse or circuit breaker size. May use fuses or HACR-type circuit breakers of the same size as noted.

Notes

- All furnaces are manufactured for use on 115 VAC, 60 Hz, single-phase electrical supply.
- Gas Service Connection ½" FPT
- Important: Size fuses and wires properly and make electrical connections in accordance with the National Electrical Code and/or all existing local codes.
- For bottom return: Failure to unfold flanges may reduce airflow by up to 18%. This could result in performance and noise issues.
- For servicing or cleaning, a 24" front clearance is required. Unit connections (electrical, flue and drain) may necessitate greater clearances than the minimum clearances listed above. In all cases, accessibility clearance must take precedence over clearances from the enclosure where accessibility clearances are greater.

PRODUCT DIMENSIONS

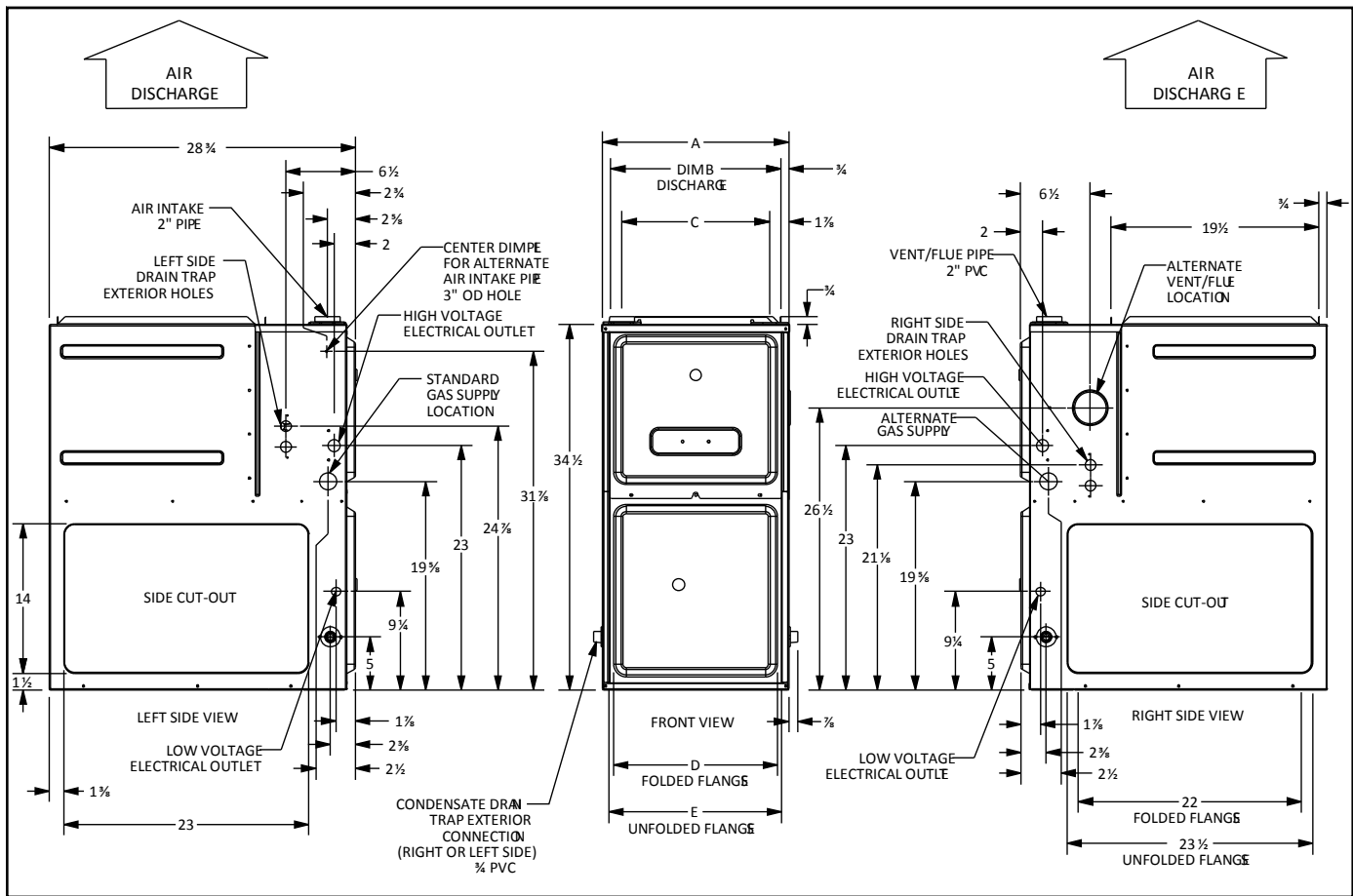

Model	W	D	H
*MVM970603BNA	17 1/2"	28 7/8"	34 1/2"
*MVM970803BNA	17 1/2"	28 7/8"	34 1/2"
*MVM970804CNA	21"	28 7/8"	34 1/2"
*MVM971005CNA	21"	28 7/8"	34 1/2"
*MVM971205DNA	24 1/2"	28 7/8"	34 1/2"

A	B	C	D	E
17 1/2"	16"	13 3/8"	12 1/8"	13 3/8"
17 1/2"	16"	13 3/8"	12 1/8"	13 3/8"
21"	19 1/2"	17 7/8"	16"	17 1/2"
21"	19 1/2"	17 7/8"	16"	17 1/2"
24 1/2"	23"	20 7/8"	19 3/8"	20 7/8"

Minimum Clearance to Combustible Materials

Position	Sides	Rear	Front	Bottom	Flue	Top
Upflow	0"	0"	3"	C	0"	1"
Horizontal	6"	0"	3"	C	0"	6"

C = If placed on combustible floor, the floor MUST be wood ONLY.

PRODUCT DIMENSIONS

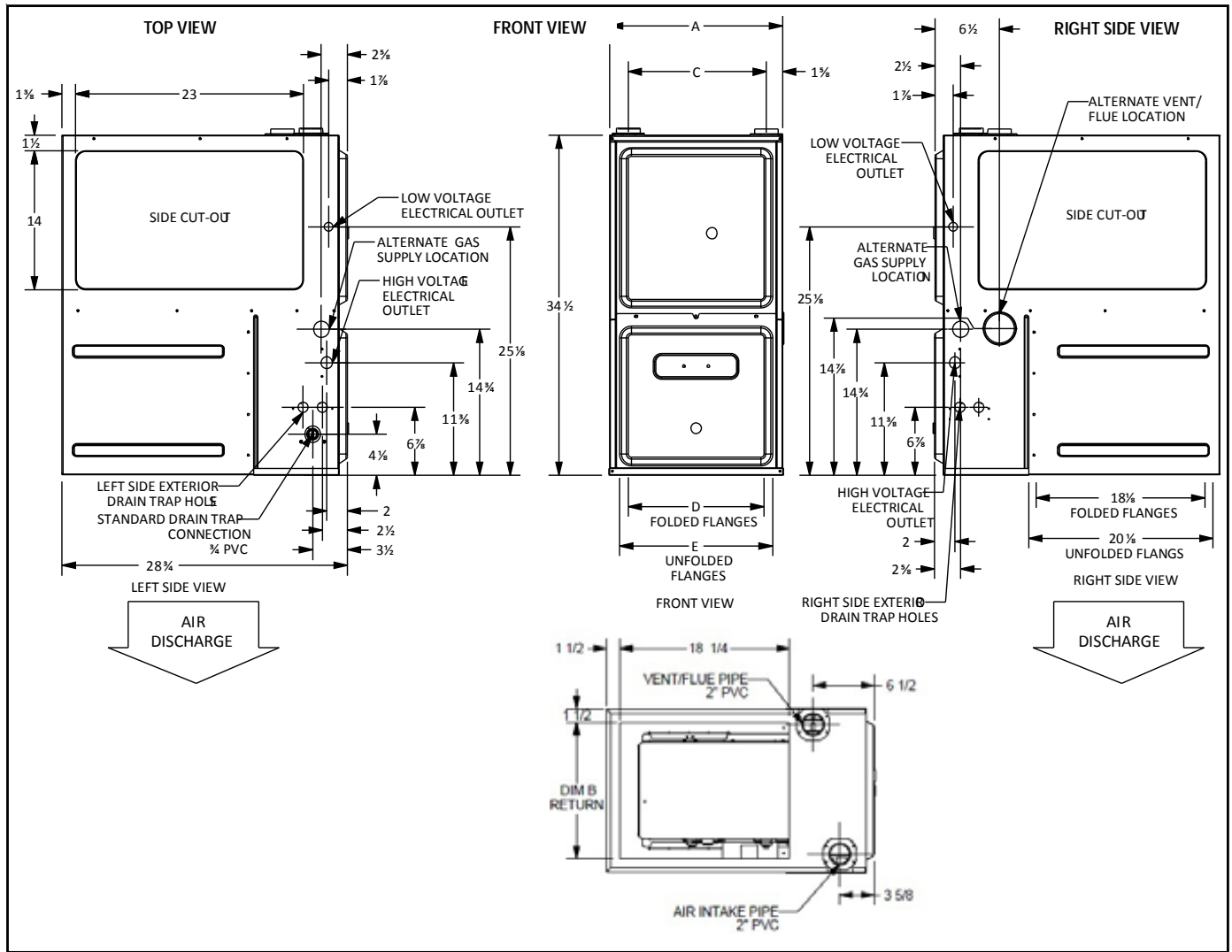

Model	W	D	H
*CVM970603BNA	17 1/2"	28 3/8"	34 1/2"
*CVM970803BNA	17 1/2"	28 3/8"	34 1/2"
*CVM970804CNA	21"	28 3/8"	34 1/2"
*CVM971005CNA	21"	28 3/8"	34 1/2"

A	B	C	D	E
17 1/2"	14 5/8"	14"	14 1/2"	13 3/8"
17 1/2"	14 5/8"	14"	14 1/2"	13 5/8"
21"	18 3/8"	17 1/2"	18"	19 1/2"
21"	18 3/8"	17 1/2"	18"	19 1/2"

Minimum Clearance to Combustible Materials

Position	Sides	Rear	Front	Bottom	Flue	Top
Downflow	0"	0"	3"	NC	0"	1"
Horizontal	6"	0"	3"	C	0"	6"

C = If placed on combustible floor, the floor MUST be wood ONLY.

NC = For installation on non-combustible floors only. A combustible floor sub-base must be used for installations on combustible flooring.

BLOWER PERFORMANCE SPECIFICATIONS

***MVM970603BNA**
Cooling Speed
(@ .1" - .8" w.c. ESP)

Tap	Adjust	High-Stage CFM	Low-Stage CFM
A	Minus 10%	539	358
	Normal	599	398
	Plus 10%	659	438
B	Minus 10%	735	501
	Normal	817	557
	Plus 10%	899	613
C	Minus 10%	906	626
	Normal	1,007	696
	Plus 10%	1,108	766
D	Minus 10%	1,091	729
	Normal	1,212	810
	Plus 10%	1,333	891

***MVM970603BNA**
Heating Speed
(@ .1" - .5" w.c. ESP; Rise Range: 20 - 50°F)

Tap	Adjust	High-Stage CFM	Rise (°F)
A	Minus 10%	858	n/a
	Normal	953	n/a
	Plus 10%	1,048	n/a
C	Minus 10%	953	n/a
	Normal	1,059	51
	Plus 10%	1,165	46
D	Minus 10%	1,042	n/a
	Normal	1,158	47
	Plus 10%	1,274	42
D	Minus 10%	1,134	48
	Normal	1,260	43
	Plus 10%	1,386	39

***MVM970803BNA**
Cooling Speed
(@ .1" - .8" w.c. ESP)

Tap	Adjust	High-Stage CFM	Low-Stage CFM
A	Minus 10%	566	363
	Normal	629	403
	Plus 10%	692	443
B	Minus 10%	725	486
	Normal	806	540
	Plus 10%	887	594
C	Minus 10%	921	635
	Normal	1,023	705
	Plus 10%	1,125	776
D	Minus 10%	1,107	737
	Normal	1,230	819
	Plus 10%	1,353	901

***MVM970803BNA**
Heating Speed
(@ .1" - .5" w.c. ESP; Rise Range: 30 - 60°F)

Tap	Adjust	High-Stage CFM	Rise (°F)
A	Minus 10%	1,082	n/a
	Normal	1,202	60
	Plus 10%	1,322	54
B	Minus 10%	1,184	n/a
	Normal	1,316	55
	Plus 10%	1,448	50
C	Minus 10%	1,250	57
	Normal	1,389	52
	Plus 10%	1,528	47
D	Minus 10%	1,256	57
	Normal	1,396	51
	Plus 10%	1,536	47

***MVM970804CNA**
Cooling Speed
(@ .1" - .8" w.c. ESP)

Tap	Adjust	High-Stage CFM	Low-Stage CFM
A	Minus 10%	710	462
	Normal	789	513
	Plus 10%	868	564
B	Minus 10%	870	594
	Normal	967	660
	Plus 10%	1,064	726
C	Minus 10%	1,064	712
	Normal	1,182	791
	Plus 10%	1,300	870
D	Minus 10%	1,238	822
	Normal	1,375	913
	Plus 10%	1,513	1,004

***MVM970804CNA**
Heating Speed
(@ .1" - .5" w.c. ESP; Rise Range: 25 - 55°F)

Tap	Adjust	High-Stage CFM	Rise (°F)
A	Minus 10%	1,105	n/a
	Normal	1,228	n/a
	Plus 10%	1,351	53
B	Minus 10%	1,203	n/a
	Normal	1,337	54
	Plus 10%	1,471	49
C	Minus 10%	1,287	n/a
	Normal	1,430	50
	Plus 10%	1,573	46
D	Minus 10%	1,364	53
	Normal	1,516	47
	Plus 10%	1,668	43

Notes:

- All furnaces ship as high speed for cooling. Installer must adjust blower speed as needed.
- For most jobs, about 400 CFM per ton when cooling is desirable.
- Do not operate above .5" w.c. ESP in heating mode.
Operating CFM between .5" and .8" w.c. is tabulated for cooling purposes only.

BLOWER PERFORMANCE SPECIFICATIONS

***MVM971005CNA**
Cooling Speed
(@ .1" - .8" w.c. ESP)

Tap	Adjust	High-Stage CFM	Low-Stage CFM
A	Minus 10%	738	508
	Normal	820	564
	Plus 10%	902	620
B	Minus 10%	1,020	706
	Normal	1,133	784
	Plus 10%	1,246	862
C	Minus 10%	1,318	884
	Normal	1,464	982
	Plus 10%	1,610	1,080
D	Minus 10%	1,562	1,133
	Normal	1,736	1,259
	Plus 10%	1,910	1,385

***MVM971005CNA**
Heating Speed
(@ .1" - .5" w.c. ESP; Rise Range: 35 - 65°F)

Tap	Adjust	High-Stage CFM	Rise (°F)
A	Minus 10%	1,636	55
	Normal	1,818	49
	Plus 10%	2,000	45
C	Minus 10%	1,683	53
	Normal	1,870	48
	Plus 10%	2,057	44
D	Minus 10%	1,719	52
	Normal	1,910	47
	Plus 10%	2,101	43
D	Minus 10%	1,761	51
	Normal	1,957	46
	Plus 10%	2,153	42

***MVM971205DNA**
Cooling Speed
(@ .1" - .8" w.c. ESP)

Tap	Adjust	High-Stage CFM	Low-Stage CFM
A	Minus 10%	780	492
	Normal	867	547
	Plus 10%	954	602
B	Minus 10%	1,044	748
	Normal	1,160	831
	Plus 10%	1,276	914
C	Minus 10%	1,320	918
	Normal	1,467	1,020
	Plus 10%	1,614	1,122
D	Minus 10%	1,719	1,150
	Normal	1,910	1,278
	Plus 10%	2,101	1,406

***MVM971205DNA**
Heating Speed
(@ .1" - .5" w.c. ESP; Rise Range: 35 - 65°F)

Tap	Adjust	High-Stage CFM	Rise (°F)
A	Minus 10%	1,702	63
	Normal	1,891	57
	Plus 10%	2,080	52
C	Minus 10%	1,746	62
	Normal	1,940	56
	Plus 10%	2,134	51
D	Minus 10%	1,771	61
	Normal	1,968	55
	Plus 10%	2,165	50
D	Minus 10%	1,825	59
	Normal	2,028	53
	Plus 10%	2,231	48

Notes

- All furnaces ship as high speed for cooling. Installer must adjust blower speed as needed.
- For most jobs, about 400 CFM per ton when cooling is desirable.
- Operation is recommended below .5" w.c. ESP in heating mode. Operating CFM between .5" and .8" w.c. is tabulated for cooling purposes only.

BLOWER PERFORMANCE SPECIFICATIONS

***CVM970603BNA**
Cooling Speed
(@ .1" - .8" w.c. ESP)

Tap	Adjust	High-Stage CFM	Low-Stage CFM
A	Minus 10%	590	390
	Normal	656	433
	Plus 10%	722	476
B	Minus 10%	711	487
	Normal	790	541
	Plus 10%	869	595
C	Minus 10%	875	617
	Normal	972	686
	Plus 10%	1,069	755
D	Minus 10%	1,076	725
	Normal	1,195	806
	Plus 10%	1,315	887

***CVM970603BNA**
Heating Speed
(@ .1" - .5" w.c. ESP; Rise Range: 35 - 65°F)

Tap	Adjust	High-Stage CFM	Rise (°F)
A	Minus 10%	844	64
	Normal	938	57
	Plus 10%	1,032	52
C	Minus 10%	855	63
	Normal	950	57
	Plus 10%	1,045	52
D	Minus 10%	887	61
	Normal	986	55
	Plus 10%	1,085	50
D	Minus 10%	893	60
	Normal	992	54
	Plus 10%	1,091	49

***CVM970803BNA**
Cooling Speed
(@ .1" - .8" w.c. ESP)

Tap	Adjust	High-Stage CFM	Low-Stage CFM
A	Minus 10%	562	365
	Normal	624	405
	Plus 10%	686	446
B	Minus 10%	727	494
	Normal	808	549
	Plus 10%	889	604
C	Minus 10%	895	610
	Normal	994	678
	Plus 10%	1,093	746
D	Minus 10%	1,059	706
	Normal	1,177	784
	Plus 10%	1,295	862

***CVM970803BNA**
Heating Speed
(@ .1" - .5" w.c. ESP; Rise Range: 35 - 65°F)

Tap	Adjust	High-Stage CFM	Rise (°F)
A	Minus 10%	950	n/a
	Normal	1,056	n/a
	Plus 10%	1,162	62
B	Minus 10%	1,031	n/a
	Normal	1,146	63
	Plus 10%	1,261	57
C	Minus 10%	1,130	64
	Normal	1,256	57
	Plus 10%	1,382	52
D	Minus 10%	1,214	59
	Normal	1,349	53
	Plus 10%	1,484	48

Notes

- All furnaces ship as high speed for cooling. Installer must adjust blower speed as needed.
- For most jobs, about 400 CFM per ton when cooling is desirable.
- Operation is recommended below .5" w.c. ESP in heating mode. Operating CFM between .5" and .8" w.c. is tabulated for cooling purposes only.

BLOWER PERFORMANCE SPECIFICATIONS

*CVM970804CNA
Cooling Speed
(@ .1" - .8" w.c. ESP)

Tap	Adjust	High-Stage CFM	Low-Stage CFM
A	Minus 10%	753	500
	Normal	837	556
	Plus 10%	921	612
B	Minus 10%	920	643
	Normal	1,022	714
	Plus 10%	1,124	785
C	Minus 10%	1,085	754
	Normal	1,206	838
	Plus 10%	1,327	922
D	Minus 10%	1,328	892
	Normal	1,475	991
	Plus 10%	1,623	1,090

*CVM970804CNA
Heating Speed
(@ .1" - .5" w.c. ESP; Rise Range: 35 - 65°F)

Tap	Adjust	High-Stage CFM	Rise (°F)
A	Minus 10%	1,111	65
	Normal	1,234	58
	Plus 10%	1,357	53
C	Minus 10%	1,193	60
	Normal	1,325	54
	Plus 10%	1,458	49
D	Minus 10%	1,298	55
	Normal	1,442	50
	Plus 10%	1,586	45
D	Minus 10%	1,375	52
	Normal	1,528	47
	Plus 10%	1,681	43

*CVM971005CNA
Cooling Speed
(@ .1" - .8" w.c. ESP)

Tap	Adjust	High-Stage CFM	Low-Stage CFM
A	Minus 10%	706	472
	Normal	784	524
	Plus 10%	862	576
B	Minus 10%	970	670
	Normal	1,078	744
	Plus 10%	1,186	818
C	Minus 10%	1,249	834
	Normal	1,388	927
	Plus 10%	1,527	1,020
D	Minus 10%	1,589	1,067
	Normal	1,766	1,185
	Plus 10%	1,943	1,304

*CVM971005CNA
Heating Speed
(@ .1" - .5" w.c. ESP; Rise Range: 35 - 65°F)

Tap	Adjust	High-Stage CFM	Rise (°F)
A	Minus 10%	1,583	57
	Normal	1,759	51
	Plus 10%	1,935	46
B	Minus 10%	1,617	56
	Normal	1,797	50
	Plus 10%	1,977	45
C	Minus 10%	1,656	54
	Normal	1,840	49
	Plus 10%	2,024	44
D	Minus 10%	1,693	53
	Normal	1,881	48
	Plus 10%	2,069	43

Notes

- All furnaces ship as high speed for cooling. Installer must adjust blower speed as needed.
- For most jobs, about 400 CFM per ton when cooling is desirable.
- Operation is recommended below .5" w.c. ESP in heating mode. Operating CFM between .5" and .8" w.c. is tabulated for cooling purposes only.

WIRING DIAGRAMS



WARNING

HIGH VOLTAGE!
DISCONNECT ALL POWER BEFORE SERVICING OR INSTALLING THIS UNIT. MULTIPLE POWER SOURCES MAY BE PRESENT. FAILURE TO DO SO MAY CAUSE PROPERTY DAMAGE, PERSONAL INJURY OR DEATH.

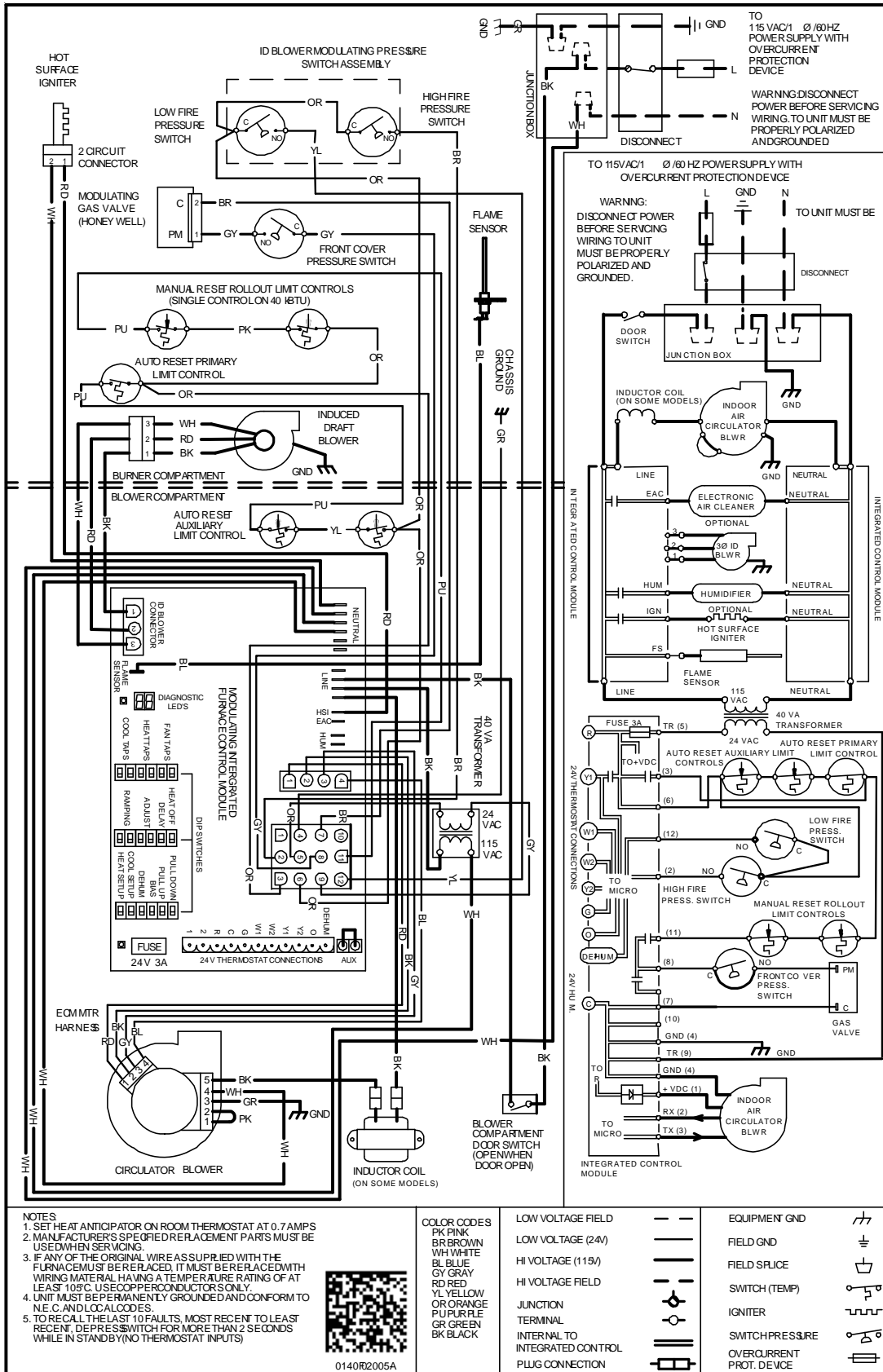

Wiring is subject to change. Always refer to the wiring diagram on the unit for the most up-to-date wiring.