



MINI SPLIT AIR CONDITIONER

# ***Installation & Owner's Manual***

## **Original Instructions**

Mini Split Air Conditioner



Thank you for choosing our product.

Please read this Installation and Owner's Manual carefully before installing and operating and retain it for future reference.

Copies of this manual may be found at:

[www.greecomfort.com/resources/dealer-resources-current-product/](http://www.greecomfort.com/resources/dealer-resources-current-product/)

VIRU30HP230V1A  
VIRU36HP230V1A

# Content

## Operation Notices

Precautions.....	1
Parts name .....	6

## Screen Operation Guide

Operation of wireless remote controller.....	7
Introduction for icons on display screen.....	7
Operation of wireless remote controller.....	8
Emergency operation .....	16

## Maintenance

Clean and maintenance.....	16
----------------------------	----

## Malfunction

Malfunction analysis .....	19
----------------------------	----

## Installation Notice

Installation dimension diagram.....	23
Safety precautions for installing and relocating the unit .....	24
Tools for installation.....	25
Selection of installation location .....	25
Requirements for electric connection .....	26

## Installation

Installation of indoor unit.....	27
Installation of outdoor unit .....	32
Vacuum pumping.....	35
Leakage detection .....	35
Check after installation .....	36

## Test and operation

Test operation.....	36
---------------------	----

## Attachment

Configuration of connection pipe.....	37
Pipe expanding method.....	39

This appliance is not intended for use by persons (including children) with reduced physical, sensory or mental capabilities or lack of experience and knowledge, unless they have been given supervision or instruction concerning use of the appliance by a person responsible for their safety. Children should be supervised to ensure that they do not play with the appliance.

If it needs to install, move or maintain the air conditioner, please contact dealer or local service center to conduct it at first. Air conditioner must be installed, moved or maintained by appointed unit. Otherwise, it may cause serious damage or personal injury or death.

## Explanation of Symbols



**DANGER**

Indicates a hazardous situation that, if not avoided, will result in death or serious injury.



**WARNING**

Indicates a hazardous situation that, if not avoided, could result in death or serious injury.



**CAUTION**

Indicates a hazardous situation that, if not avoided, may result in minor or moderate injury.

**NOTICE**

Indicates important but not hazard-related information, used to indicate risk of property damage.



Indicates a hazard that would be assigned a signal word **WARNING** or **CAUTION**.

## Exception Clauses

Manufacturer will bear no responsibilities when personal injury or property loss is caused by the following reasons.

1. Damage the product due to improper use or misuse of the product;
2. Alter, change, maintain or use the product with other equipment without abiding by the instruction manual of manufacturer;
3. After verification, the defect of product is directly caused by corrosive gas;
4. After verification, defects are due to improper operation during transportation of product;
5. Operate, repair, maintain the unit without abiding by instruction manual or related regulations;
6. After verification, the problem or dispute is caused by the quality specification or performance of parts and components that produced by other manufacturers;
7. The damage is caused by natural calamities, bad using environment or force majeure.



## Precautions



### WARNING

- Maintenance must be performed by qualified professionals. Otherwise, it may cause personal injury or damage.
- Do not repair air conditioner by yourself. It may cause electric shock or damage. Please contact a licensed HVAC contractor whenever repair is needed.
- To prevent possible personal injury or damage, keep fingers and objects clear of air inlet or outlet.
- For proper air flow, keep air outlet and inlet free of obstructions.
- Do not spill water on the remote controller, controller may malfunction.
- When any of the following occurs, please turn off air conditioner and disconnect power immediately and contact a licensed HVAC technician for service.
  - Power cord is overheating or damaged.
  - Any abnormal sound during operation.
  - Circuit breaker trips frequently.
  - Air conditioner gives off burning smell.
  - Indoor unit is leaking.
- If the air conditioner operates abnormally, it may malfunction, creating electric shock or a fire hazard.
- When turning on or off the unit using the emergency switch, press with an insulated (not metal) object.
- Do not step on or place heavy objects on the outdoor unit top panel. It could cause damage or personal injury.



### WARNING

#### Attachment

- Installation must be performed by licensed, qualified professionals.
- Follow all electric safety regulations and codes when installing the unit.
- According to the local code, use qualified power supply circuit wiring and circuit breakers.
- Install circuit breakers to protect you and your equipment.
- An all-pole disconnect switch having a contact separation of at least 3mm in all poles should be used. Including an circuit breaker with suitable capacity, per the following table.
- A typical magnetic or temperature activated breaker will protect against short circuits and overloads.
- This Air Conditioner should be properly grounded. Incorrect grounding may cause electric shock.
- Don't use an improperly sized power cord.
- Make sure the power supply matches with the requirement of air conditioner.
- Unstable power supply or incorrect wiring can cause the equipment to malfunction. Please install proper power supply cables before using the air conditioner.
- Follow wiring instructions to properly connect the load, neutral and ground wires to terminals.
- Be sure to disconnect the power supply before doing any electrical or maintenance work.

## Precautions



### WARNING

- Do not turn on the power before finishing installation.
- If the supply cord is damaged, it must be replaced by the manufacturer or qualified licensed professionals in order to avoid a hazard.
- The temperature of refrigerant circuit will be high, please keep the interconnecting wire away from the copper tubing.
- The appliance shall be installed in accordance with national/local wiring codes/regulations.
- Installation must be performed in accordance with the requirements of NEC and CEC by authorized personnel only.
- The air conditioner is a first class electric appliance. It must be properly grounded by a licensed professional. Make sure the system is properly grounded to avoid electrical shock or fire.
- The yellow-green wire in air conditioner is ground wire, and can't be used for other purposes.
- The grounding resistance should comply with national electric safety regulations.
- The appliance must be positioned so that the connection terminals are accessible.
- All wires of indoor unit and outdoor unit should be connected by a licensed professional.
- If the length of power connection wire not correct, contact your supplier for the correct wire length, do not splice.

## Precautions



### WARNING

- All wiring terminal strips and connection boxes must be easily accessible for installation and service.
- For the air conditioner without plug, an circuit breaker must be installed and easily accessible.
- To avoid personal injury or damage, if you need to relocate the air conditioner, only a qualified licensed technician should perform the work.
- Select a location out of reach for children and far away from animals or plants. If it is unavoidable, please add a fence for safety purposes.
- The indoor unit should be installed close to the wall.
- Instructions for installation and use of this product are provided by the manufacturer.
- If the unit is off for an extended period at  $-5^{\circ}\text{F}$  or lower outside ambient temperature, power-on the unit for 4 hours or more to preheat before starting.

### Working temperature range

	Indoor side DB/WB( $^{\circ}\text{C}/^{\circ}\text{F}$ )	Outdoor side DB/WB( $^{\circ}\text{C}/^{\circ}\text{F}$ )
Maximum cooling	27/19(81/66)	46/24(115/75)
Maximum heating	27/81)	24/18(75/64)

### **NOTICE:**

- The operating temperature range (outdoor temperature) for cooling only unit is  $-18^{\circ}\text{C} \sim 46^{\circ}\text{C}$  ( $0 \sim 115^{\circ}\text{F}$ ); for heat pump unit is  $-35^{\circ}\text{C} \sim 46^{\circ}\text{C}$  ( $-31 \sim 115^{\circ}\text{F}$ ).

# Parts name

## Indoor Unit

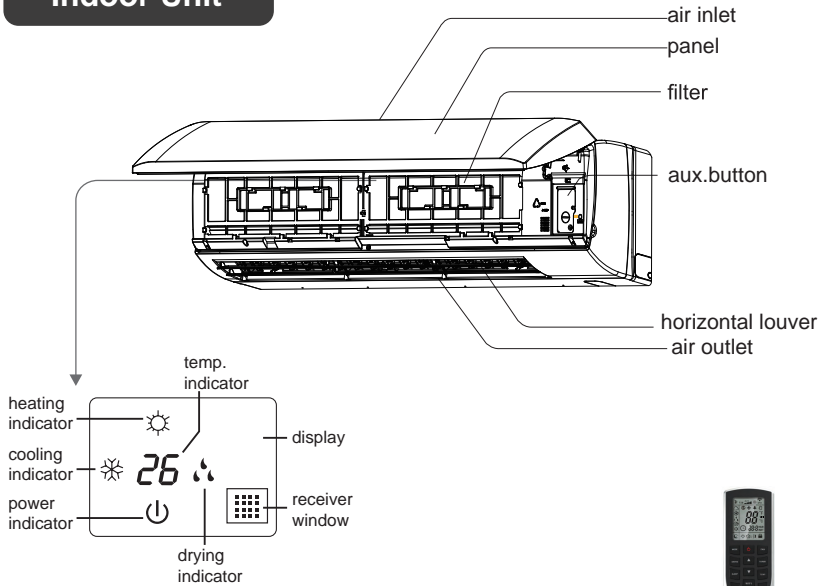

(Display content or position may be different from above graphics, please refer to actual products)



remote control

## Outdoor Unit

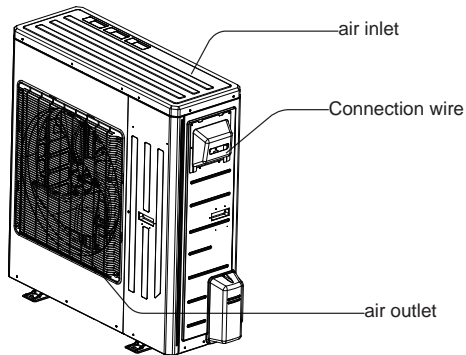

### **NOTICE:**

Actual product may be different from above graphics, please refer to actual products.

# OPERATION OF WIRELESS REMOTE CONTROLLER

## Remote Controller

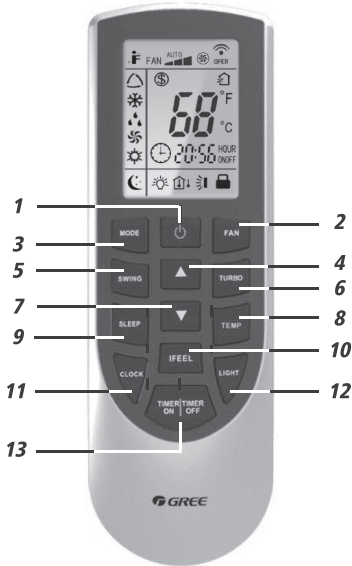

### Part Name

1. ON/OFF Button
2. Fan Button
3. Mode Button
4. Up Button
5. Swing Button
6. Turbo Button
7. Down Button
8. Temp Button
9. Sleep Button
10. I Feel Button
11. Clock Button
12. Light Button
13. Timer On/Off Button

## INTRODUCTION FOR ICONS ON DISPLAY SCREEN

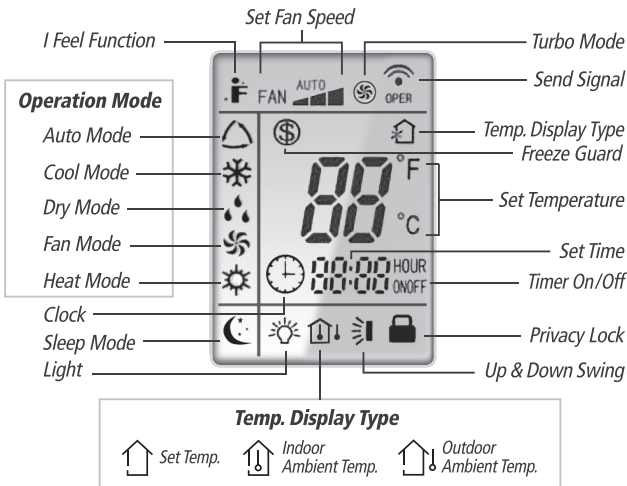

# OPERATION OF WIRELESS REMOTE CONTROLLER

## REMOTE CONTROLLER OPERATIONS

The wireless remote controller is sleek, versatile and allows you to change room temperatures and functions on your Vireo system from the palm of your hand. The large LCD display and buttons make it easy-to-understand and easy-to-use.

The remote controller is set from factory to display temperatures in °F. If °C is desired, turn the remote controller **OFF** with the **ON/OFF** button and then press "**MODE**" and "**▼**" buttons on the remote simultaneously for 5 seconds.

### ON/OFF BUTTON

When the system is in **OFF** mode, the remote controller will display the time and last room setpoint. When you press the **ON/OFF** button, this indicator  will be displayed and the unit will start in the last operating mode and room setpoint.

**NOTE:** If the **ON/OFF** button is pressed too soon after a stop, the compressor will not start for 1 to 5 min. due to the inherent protection against frequent compressor cycling.



ON Mode Display

### DISPLAYING SETPOINT OR INDOOR TEMPERATURE ON FRONT PANEL:

The setpoint temperature or room temperature can be displayed on the front panel. Only setpoint temperature is displayed on the remote controller.

When the "**TEMP**" button is pushed once, the temperature indicator  is displayed. This indicates that the setpoint temperature is displayed on the front panel.

When the "**TEMP**" button is pushed a second time, the display will show an  icon with a thermometer inside a house. This indicates that the room temperature is displayed on the front panel.

The room temperature will be displayed for only 5 seconds before reverting back to displaying room setpoint.





Room Temperature Display

# OPERATION OF WIRELESS REMOTE CONTROLLER

## VERTICAL SWING LOUVERS

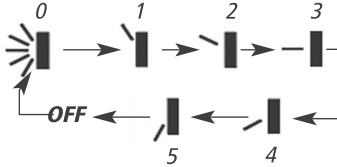
- Press the Vertical Swing Louver button to select five different vertical (up & down) air discharge directions including Continuous Sweep. The Swing Louver  icon will be displayed. Press this button to set swing angle, which changes in direction as below:



 Indicates louver swings up and down in the five directions, as shown.



Swing Louver Display

## PRIVACY LOCK

The Privacy Lock prevents unauthorized access to the unit controls and prevents tampering with system settings. The remote controller can be locked by pushing the "▲" and "▼" buttons simultaneously for 5 seconds. The Privacy Lock icon will be displayed on the remote controller. Repeat the process to unlock the remote controller.



Privacy Lock Display

## I FEEL MODE

Press this button to use the I FEEL function, and the  icon will be displayed. The unit will sense room temperature at the remote controller instead of at the indoor unit. It then adjusts airflow and temperature accordingly for the ultimate in personal comfort control and energy savings. Press the button again to exit this function. For best performance, keep remote controller away from heat or cold temperature sources while using this function.



I Feel Mode



# OPERATION OF WIRELESS REMOTE CONTROLLER

## MODE BUTTON

Use the "MODE" button to select one of the available modes. The selected mode will be displayed on the remote controller and the appropriate light will illuminate on the front display panel.

**AUTO** – Unit will automatically select heating or cooling to maintain room temperature between 68°F and 77°F. The remote controller will display the Auto Mode icon with no setpoint.

**COOL** – To cool to selected setpoint and remove moisture. Press ▲ or ▼ to adjust set temperature. System varies compressor speed to maintain desired temperature.

**HEAT** – To heat to selected room setpoint. Press ▲ or ▼ to adjust set temperature. System varies compressor speed to maintain desired room temperature.

**FAN ONLY** – To circulate air without heating or cooling. Use Fan Speed button to select speed from low to high.

**DRY** – Select **DRY MODE** to increase moisture removal during warm humid conditions. In this mode, fan speed cannot be adjusted.

1. If the Room Temperature is more than 4°F above the set temperature, the system will be operating in cooling mode with low fan speed.
2. If the Room Temperature is between 4°F higher than, and 4°F less than, the set temperature, the system will cycle 6 minutes **ON** and 4 minutes **OFF** in cooling mode. The indoor fan will be at low speed.
3. If the Room Temperature is more than 4°F below the set temperature, the system will be **OFF** and the indoor fan will be at low speed.

## FREEZE GUARD

In Heat mode, press "TEMP" and "CLOCK" buttons simultaneously to start up 46°F heating function. When this function is started up, "(\$)" and "46°F" will be displayed on the remote controller, and the unit will maintain room temperature above 46°F. Press "TEMP" and "CLOCK" buttons simultaneously again to cancel Freeze Guard protection.

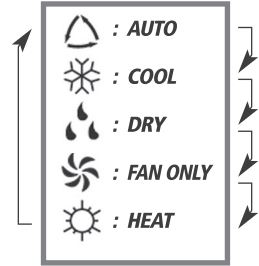

Icons Displayed

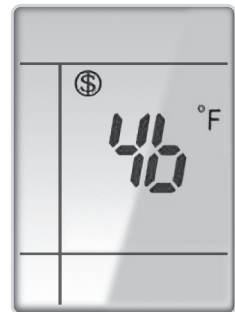

Freeze Guard Display

# OPERATION OF WIRELESS REMOTE CONTROLLER

## TIMER SETTING

### Timer-ON / Timer-OFF BUTTON

To set when you want the unit to turn On at the end of a selected time period, use the button labeled "Timer-ON / Timer-OFF" on the remote controller. Press this button to make the clock icon disappear, replaced with the word "ON" (blinking). Press ▲ or ▼ buttons to adjust timer setting 1 minute at a time. Press and hold ▲ or ▼ button to set timer more quickly. Press "Timer-ON / Timer-OFF" button again to confirm setting, and the word "ON" will stop blinking. To cancel, press "Timer-ON / Timer-OFF" button again.



Timer Setting ON/OFF

To set when you want the unit to turn Off at the end of a selected time period, use the same button. Press this button to make the clock icon disappear, replaced with the word "OFF" (blinking). Adjust settings the same as with "Timer-ON / Timer-OFF" settings.

**NOTE:** Under Timer On and Off status, you can set "Timer-ON / Timer-OFF" simultaneously. Before setting timer, be sure to set clock to correct time.

## TURBO MODE

The desired room setpoint can be achieved faster in **TURBO** mode. After selecting the "HEAT" or "COOL" mode button, push the "TURBO" button. The **TURBO**  icon will be displayed on the remote controller and the unit will run at an ultra-high speed. To deactivate the feature, push the "TURBO" button again. The unit will return to normal operation.

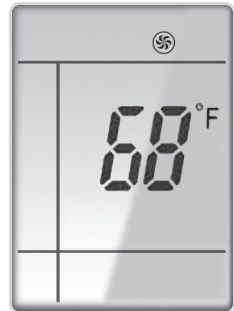

Turbo Mode Display

## LIGHT BUTTON

Press this button to turn off display light on indoor unit. Press again to turn it back on.



Light Display

# OPERATION OF WIRELESS REMOTE CONTROLLER

## FAN BUTTON

Press the FAN button to adjust the indoor fan speed:

Low (▲), Medium (▲▲), High (▲▲▲), Turbo and Auto.

- Turbo function is not available in Dry and Auto mode.
- The fan operates at low speed in Dry and Auto modes, and the speed cannot be adjusted.
- When Auto is selected, the unit will select the proper fan speed automatically, according to the ambient temperature.

**NOTE:** Turbo function is not available in Dry and Auto Modes. The Vireo unit will select proper fan speed automatically according to ambient temperature.

## CLOCK SETTING

Press this button to set clock time. "⌚" icon on remote controller will blink. Within 5 seconds, press ▲ or ▼ button to set clock time. With each pressing of ▲ or ▼ buttons, clock time will increase or decrease 1 minute. To quickly adjust time setting, press and hold ▲ or ▼ button for 2 seconds. Release button when you have reached the desired time setting. Press "CLOCK" button to confirm the time, and "⌚" icon will stop blinking.

**NOTE:** Clock time adopts 24-hour mode. A 12-hour time format is not available.

## ENERGY-SAVING

In Cool mode, press "TEMP" and "CLOCK" buttons simultaneously to start the energy-saving function. "SE" will be shown on remote controller, and the unit will adjust the set temperature automatically to reach to the best energy-saving effect. Press "TEMP" and "CLOCK" buttons simultaneously again to cancel energy-saving mode.

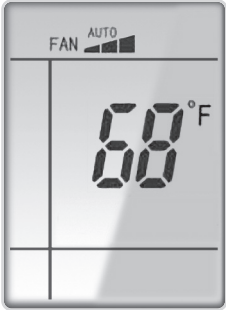

Fan Display



Clock Setting Display

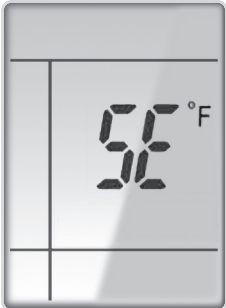

Energy Saving Display

# OPERATION OF WIRELESS REMOTE CONTROLLER

## SLEEP MODE

The Vireo system will automatically adjust room temperature during your sleep time. This slight change in temperature will not affect your comfort level due to the natural effects that sleeping has on the body, but it will save on energy consumption and will lower your electric bill. The Vireo System has three Sleep Modes to select from. Press the SLEEP button to select Sleep 1, Sleep 2, Sleep 3 modes or Cancel. The SLEEP  icon will appear.

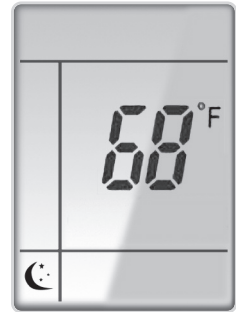

Sleep Mode Display

## TRADITIONAL MODE - SLEEP 1

In Traditional Mode the unit will slowly relax the room set temperature by up to 4° F until Sleep Mode is cancelled.

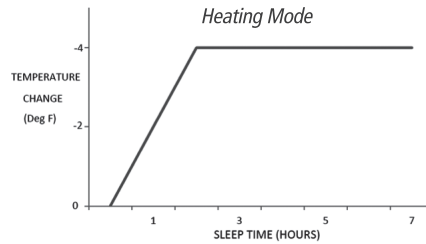
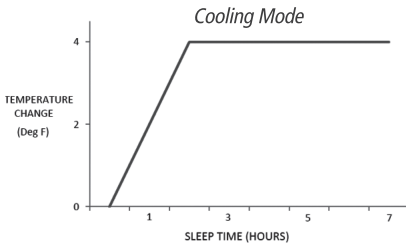

## EXPERT MODE - SLEEP 2

In Expert Mode the unit will adjust the room set temperature at a rate based on the starting set temperature value. Sleep Mode will continue until cancelled.

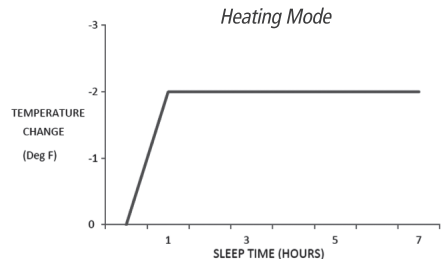
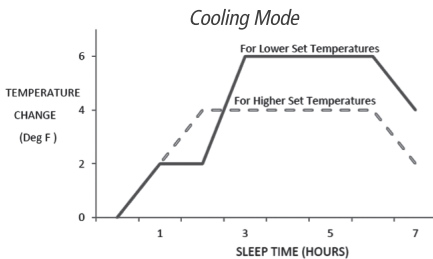

# OPERATION OF WIRELESS REMOTE CONTROLLER

---

## DIY MODE - SLEEP 3

You will be required to enter eight (8) room setpoint values for eight (8) hours of run time. The last room setpoint value will be maintained until sleep mode is cancelled.

In Sleep Mode 3, press "Prog" button to enter setup mode. The remote controller will display "1:00" in the time location. Use the "+" and "-" buttons to select the desired room setpoint for the first hour of run time. Then press the "Prog" button to save the setpoint.

The remote controller time display will change to "2:00." Once again, use the "+" and "-" buttons to select the desired room setpoint for the second hour of run time, and press the "Prog" button to again save the setpoint.

Repeat this sequence for the eight (8) room setpoint values. After all eight (8) values have been entered, the remote controller will automatically revert to standard time and temperature display, and the Sleep 3 Mode will begin.

At any time, you may press the "ON/OFF," " Mode," " Timer," "Sleep" or "Turbo" buttons to cancel the Sleep 3 Mode.

**NOTE:** During this procedure, if no button is pressed within 10 seconds, remote controller will automatically exit the sleep curve setting and resume original display. If ON/OFF, MODE, TIMER, SLEEP, COOLING or HEATING button is pressed during the setting or inquiry procedure, remote controller will also exit the sleep curve setting.

Sleep function will be disabled if the air conditioner is restarted after power failure; Sleep function can not be set in AUTO mode.

# OPERATION OF WIRELESS REMOTE CONTROLLER

---

## CHANGING BATTERIES AND ADDITIONAL NOTES

To change batteries, slide cover off battery compartment on back of remote controller. Remove and safely discard old batteries. Insert two new AAA 1.5V dry batteries, using correct polarity. Reattach back cover.

### NOTE:

- If the remote controller will not be used for a long time, remove batteries to prevent leakage damage.
- Be sure to aim the remote controller at the receiver of the main unit when operating.
- When remote emits a signal, icon will flicker; a tone will be heard when unit receives that signal.

## CHANGING BATTERIES

**Remove  
old batteries**

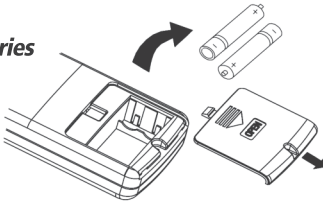

**Install  
new batteries**

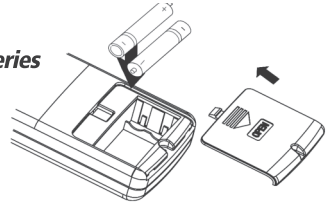

## Emergency operation

If remote controller is lost or damaged, please use auxiliary button to turn on or turn off the air conditioner. The operation in details are as below: As shown in the fig. Open panel, press aux. button to turn on or turn off the air conditioner. When the air conditioner is turned on, it will operate under auto mode.

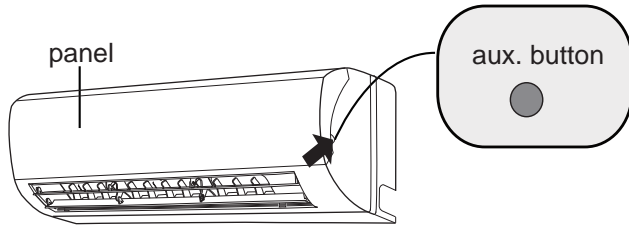

### **WARNING:**

Use insulated object to press the auto button

## Clean and maintenance

### **WARNING**

- Turn off the air conditioner and disconnect the power before cleaning the air conditioner to avoid electric shock.
- Do not wash the air conditioner with water to avoid electric shock.
- Do not use volatile liquid to clean the air conditioner.

### Clean surface of indoor unit

When the surface of indoor unit is dirty, it is recommended to use a soft dry cloth or wet cloth to wipe it.

### **NOTICE:**

- Do not remove the panel when cleaning it.

# Clean and maintenance

## Clean filter

### 1 Open panel

Pull out the panel to a certain angle as shown in the fig.

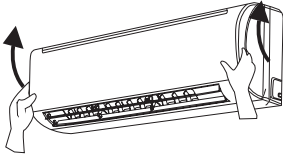

### 2 Remove filter

Remove the filter as indicated in the fig.

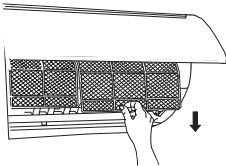

### 3 Clean filter

- Use dust catcher or water to clean the filter.
- When the filter is very dirty, use the water (below 45°C (113°F)) to clean it, and then put it in a shady and cool place to dry.

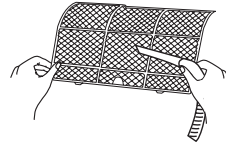

### 4 Install filter

Install the filter and then close the panel cover tightly.

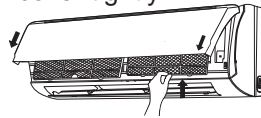

## WARNING

- The filter should be cleaned every three months. If there is much dust in the operation environment, clean frequency can be increased.
- After removing the filter, do not touch fins to avoid injury.
- Do not use fire or hair dryer to dry the filter to avoid deformation or fire hazard.



# Clean and maintenance

## **NOTICE: Checking before use-season**

1. Check whether air inlets and air outlets are blocked.
2. Check whether circuit break, plug and socket are in good condition.
3. Check whether filter is clean.
4. Check whether mounting bracket for outdoor unit is damaged or corroded.  
If yes, please contact dealer.
5. Check whether drainage pipe is damaged.

## **NOTICE: Checking after use-season**

1. Disconnect power supply.
2. Clean filter and indoor unit's panel.
3. Check whether mounting bracket for outdoor unit is damaged or corroded.  
If yes, please contact dealer.

## **Notice for recovery**

1. Many packing materials are recyclable materials.  
Please dispose them in appropriate recycling unit.
2. If you want to dispose the air conditioner, please contact local dealer or consultant service center for the correct disposal method.

# Malfunction analysis

## General phenomenon analysis

Please check below items before asking for maintenance. If the malfunction still can't be eliminated, please contact local dealer or qualified professionals.

Phenomenon	Check items	Solution
Indoor unit can't receive remote controller's signal or remote controller has no action.	<ul style="list-style-type: none"> <li>Whether it's interfered severely (such as static electricity, stable voltage)?</li> </ul>	<ul style="list-style-type: none"> <li>Pull out the plug. Reinsert the plug after about 3min, and then turn on the unit again.</li> </ul>
	<ul style="list-style-type: none"> <li>Whether remote controller is within the signal receiving range?</li> </ul>	<ul style="list-style-type: none"> <li>Signal receiving range is 8m.</li> </ul>
	<ul style="list-style-type: none"> <li>Whether there are obstacles?</li> </ul>	<ul style="list-style-type: none"> <li>Remove obstacles.</li> </ul>
	<ul style="list-style-type: none"> <li>Whether remote controller is pointing at the receiving window?</li> </ul>	<ul style="list-style-type: none"> <li>Select proper angle and point the remote controller at the receiving window on indoor unit.</li> </ul>
	<ul style="list-style-type: none"> <li>Is sensitivity of remote controller low; fuzzy display and no display?</li> </ul>	<ul style="list-style-type: none"> <li>Check the batteries. If the power of batteries is too low, please replace them.</li> </ul>
	<ul style="list-style-type: none"> <li>No display when operating remote controller?</li> </ul>	<ul style="list-style-type: none"> <li>Check whether remote controller appears to be damaged. If yes, replace it.</li> </ul>
	<ul style="list-style-type: none"> <li>Fluorescent lamp in room?</li> </ul>	<ul style="list-style-type: none"> <li>Take the remote controller close to indoor unit.</li> <li>Turn off the fluorescent lamp and then try it again.</li> </ul>
No air emitted from indoor unit	<ul style="list-style-type: none"> <li>Air inlet or air outlet of indoor unit is blocked?</li> </ul>	<ul style="list-style-type: none"> <li>Eliminate obstacles.</li> </ul>
	<ul style="list-style-type: none"> <li>Under heating mode, indoor temperature is reached to set temperature?</li> </ul>	<ul style="list-style-type: none"> <li>After reaching to set temperature, indoor unit will stop blowing out air.</li> </ul>
	<ul style="list-style-type: none"> <li>Heating mode is turned on just now?</li> </ul>	<ul style="list-style-type: none"> <li>In order to prevent blowing out cold air, indoor unit will be started after delaying for several minutes, which is a normal phenomenon.</li> </ul>

# Malfunction analysis

Phenomenon	Check items	Solution
Air conditioner can't operate	• Power failure?	• Wait until power recovery.
	• Is plug loose?	• Reinsert the plug.
	• Circuit break trips off or fuse is burnt out?	• Ask professional to replace circuit break or fuse.
	• Wiring has malfunction?	• Ask professional to replace it.
	• Unit has restarted immediately after stopping operation?	• Wait for 3min, and then turn on the unit again.
	• Whether the function setting for remote controller is correct?	• Reset the function.
Mist is emitted from indoor unit's air outlet	• Indoor temperature and humidity is high?	• Because indoor air is cooled rapidly. After a while, indoor temperature and humidity will be decrease and mist will disappear.
Set temperature can't be adjusted	• Unit is operating under auto mode?	• Temperature can't be adjusted under auto mode. Please switch the operation mode if you need to adjust temperature.
	• Your required temperature exceeds the set temperature range?	• Set temperature range: 16°C ~30°C .
Cooling (heating) effect is not good.	• Voltage is too low?	• Wait until the voltage resumes normal.
	• Filter is dirty?	• Clean the filter.
	• Set temperature is in proper range?	• Adjust temperature to proper range.
	• Door and window are open?	• Close door and window.

# Malfunction analysis

Phenomenon	Check items	Solution
Odours are emitted	<ul style="list-style-type: none"> <li>• Whether there's odour source, such as furniture and cigarette, etc.</li> </ul>	<ul style="list-style-type: none"> <li>• Eliminate the odour source.</li> <li>• Clean the filter.</li> </ul>
Air conditioner operates abnormally	<ul style="list-style-type: none"> <li>• Whether there's interference, such as thunder, wireless devices, etc.</li> </ul>	<ul style="list-style-type: none"> <li>• Disconnect power, put back power, and then turn on the unit again.</li> </ul>
Outdoor unit has vapor	<ul style="list-style-type: none"> <li>• Heating mode is turned on?</li> </ul>	<ul style="list-style-type: none"> <li>• During defrosting under heating mode, it may generate vapor, which is a normal phenomenon.</li> </ul>
"Water flowing" noise	<ul style="list-style-type: none"> <li>• Air conditioner is turned on or turned off just now?</li> </ul>	<ul style="list-style-type: none"> <li>• The noise is the sound of refrigerant flowing inside the unit, which is a normal phenomenon.</li> </ul>
Cracking noise	<ul style="list-style-type: none"> <li>• Air conditioner is turned on or turned off just now?</li> </ul>	<ul style="list-style-type: none"> <li>• This is the sound of friction caused by expansion and/or contraction of panel or other parts due to the change of temperature.</li> </ul>

# Malfunction analysis

## Error Code

- When air conditioner status is abnormal, temperature indicator on indoor unit will blink to display corresponding error code. Please refer to below list for identification of error code.

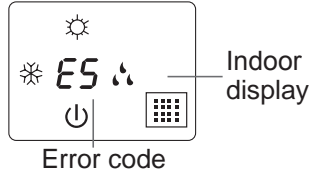

Above indicator diagram is only for reference. Please refer to actual product for the actual indicator and position.

Error code	Troubleshooting
H1 (Heating indicator ON 10s OFF 0.5s)	Means defrosting status. It's the normal phenomenon.
E5	It can be eliminated after restarting the unit. If not, please contact qualified professionals for service.
H6	It can be eliminated after restarting the unit. If not, please contact qualified professionals for service.
C5	Please contact qualified professionals for service.
F1	Please contact qualified professionals for service.
F2	Please contact qualified professionals for service.
E6	It can be eliminated after restarting the unit. If not, please contact qualified professionals for service.
F0	Please contact qualified professionals for service.

Note: If there're other error codes, please contact qualified professionals for service.



## WARNING

- When below phenomenon occurs, please turn off air conditioner and disconnect power immediately, and then contact the dealer or qualified professionals for service.
  - Power cord is overheating or damaged.
  - There's abnormal sound during operation.
  - Circuit break trips off frequently.
  - Air conditioner gives off burning smell.
  - Indoor unit is leaking.
- Do not repair or refit the air conditioner by yourself.
- If the air conditioner operates under abnormal conditions, it may cause malfunction, electric shock or fire hazard.

# Installation dimension diagram

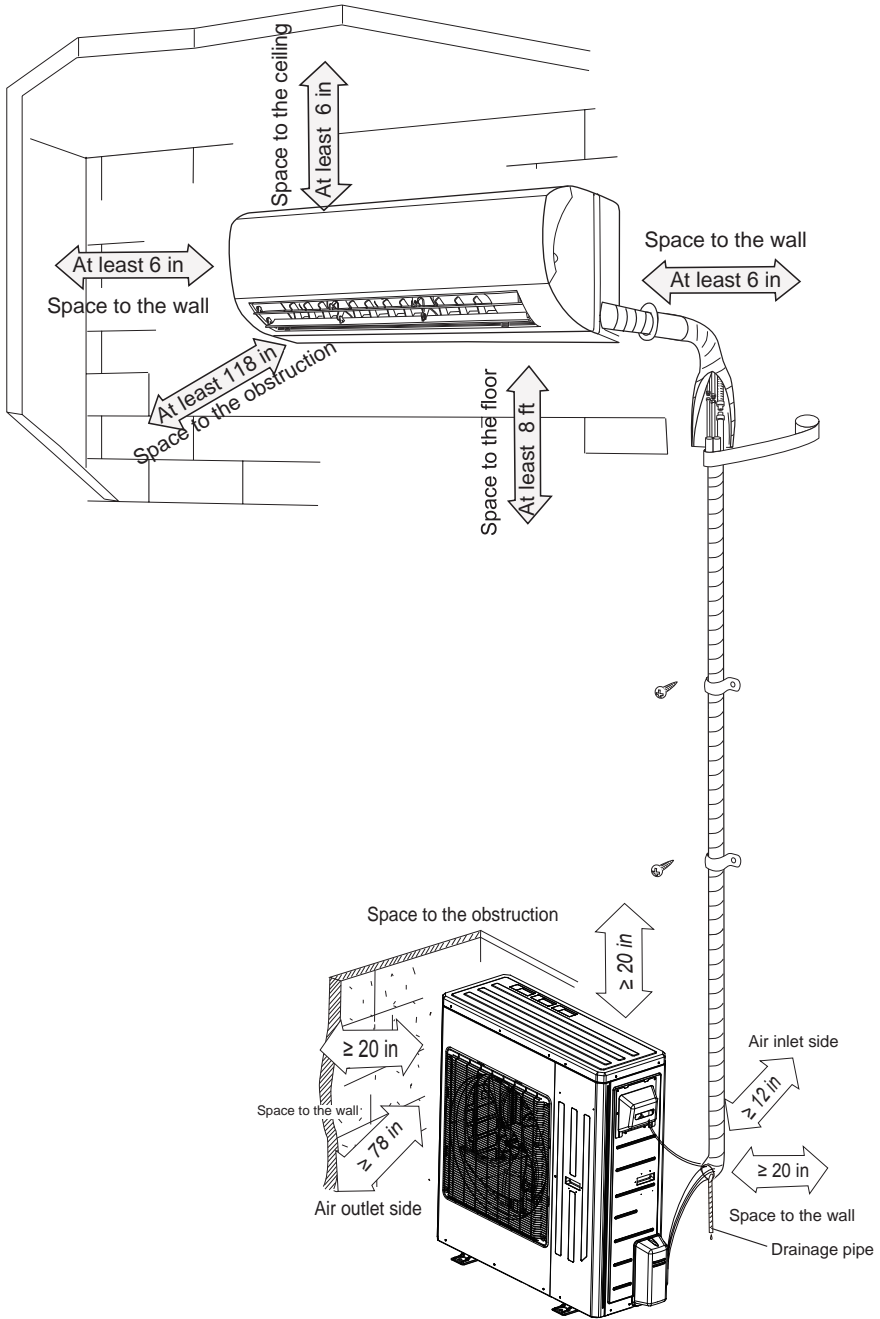

# Safety precautions for installing and relocating the unit

To ensure safety, please be mindful of the following precautions.

## Warning

- **When installing or relocating the unit, be sure to keep the refrigerant circuit free from air or substances other than the specified refrigerant.**  
Any presence of air or other foreign substance in the refrigerant circuit will cause system pressure rise or compressor rupture, resulting in injury.
- **When installing or moving this unit, do not charge the refrigerant which is not comply with that on the nameplate or unqualified refrigerant.**  
Otherwise, it may cause abnormal operation, wrong action, mechanical malfunction or even series safety accident.
- **When refrigerant needs to be recovered during relocating or repairing the unit, be sure that the unit is running in cooling mode. Then, fully close the valve at high pressure side (liquid valve). About 30-40 seconds later, fully close the valve at low pressure side (gas valve), immediately stop the unit and disconnect power. Please note that the time for refrigerant recovery should not exceed 1 minute.**  
If refrigerant recovery takes too much time, air may be sucked in and cause pressure rise or compressor rupture, resulting in injury.
- **During refrigerant recovery, make sure that liquid valve and gas valve are fully closed and power is disconnected before detaching the connection pipe.**  
If compressor starts running when stop valve is open and connection pipe is not yet connected, air will be sucked in and cause pressure rise or compressor rupture, resulting in injury.
- **When installing the unit, make sure that connection pipe is securely connected before the compressor starts running.**  
If compressor starts running when stop valve is open and connection pipe is not yet connected, air will be sucked in and cause pressure rise or compressor rupture, resulting in injury.
- **Prohibit installing the unit at the place where there may be leaked corrosive gas or flammable gas.**  
If there leaked gas around the unit, it may cause explosion and other accidents.
- **Do not use extension cords for electrical connections. If the electric wire is not long enough, please contact a local service center authorized and ask for a proper electric wire.**  
Poor connections may lead to electric shock or fire.
- **Use the specified types of wires for electrical connections between the indoor and outdoor units. Firmly clamp the wires so that their terminals receive no external stresses.**  
Electric wires with insufficient capacity, wrong wire connections and insecure wire terminals may cause electric shock or fire.

## Tools for installation

1 Level meter	2 Screw driver	3 Impact drill
4 Drill head	5 Pipe expander	6 Torque wrench
7 Open-end wrench	8 Pipe cutter	9 Leakage detector
10 Vacuum pump	11 Pressure meter	12 Universal meter
13 Inner hexagon spanner		14 Measuring tape

### Note:

- Please contact the local agent for installation.
- Don't use unqualified power cord.

## Selection of installation location

### Basic requirement

Installing the unit in the following places may cause malfunction. If it is unavoidable, please consult the local dealer:

1. The place with strong heat sources, vapors, flammable or explosive gas or volatile objects spread in the air.
2. The place with high-frequency devices (such as welding machine, medical equipment).
3. The place near coast area.
4. The place with oil or fumes in the air.
5. The place with sulfured gas.
6. Other places with special circumstances.
7. The appliance shall not be installed in the laundry.
8. It's not allowed to be installed on the unstable or motive base structure (such as truck) or in the corrosive environment (such as chemical factory).

### Indoor unit

1. There should be no obstruction near air inlet and air outlet.
2. Select a location where the condensation water can be dispersed easily and won't affect other people.
3. Select a location which is convenient to connect the outdoor unit and near the power socket.
4. Select a location which is out of reach for children.
5. The location should be able to withstand the weight of indoor unit and won't increase noise and vibration.
6. The appliance must be installed 2.5m above floor.
7. Don't install the indoor unit right above the electric appliance.
8. Please try your best to keep way from fluorescent lamp.

### Outdoor unit

1. Select a location where the noise and outflow air emitted by the outdoor unit will not affect neighborhood.
2. The location should be well ventilated and dry, in which the outdoor unit won't be exposed directly to sunlight or strong wind.
3. The location should be able to withstand the weight of outdoor unit.
4. Make sure that the installation follows the requirement of installation dimension diagram.
5. Select a location which is out of reach for children and far away from animals or plants. If it is unavoidable, please add the fence for safety purpose.



# Requirements for electric connection

## Safety precaution

1. Must follow the electric safety regulations when installing the unit.
2. According to the local safety regulations, use qualified power supply circuit and circuit break.
3. Make sure the power supply matches with the requirement of air conditioner. Unstable power supply or incorrect wiring or malfunction. Please install proper power supply cables before using the air conditioner.
4. Properly connect the live wire, neutral wire and grounding wire of power socket.
5. Be sure to cut off the power supply before proceeding any work related to electricity and safety.
6. Do not put through the power before finishing installation.
7. If the supply cord is damaged, it must be replaced by the manufacturer, its service agent or similarly qualified persons in order to avoid a hazard.
8. The temperature of refrigerant circuit will be high, please keep the interconnection cable away from the copper tube.
9. The appliance shall be installed in accordance with national wiring regulations.
10. Installation must be performed in accordance with the requirement of NEC and CEC by authorized personnel only

## Electrical connection requirement

1. The air conditioner is the first class electric appliance. It must be properly grounding with specialized grounding device by a professional. Please make sure it is always grounded effectively, otherwise it may cause electric shock.
2. The yellow-green wire in air conditioner is grounding wire, which can't be used for other purposes.
3. The grounding resistance should comply with national electric safety regulations.
4. The appliance must be positioned so that the plug is accessible.
5. An all-pole disconnection switch having a contact separation of at least 3mm in all poles should be connected in fixed wiring.
6. Please do install the air switch. Otherwise, it may cause the malfunction.
7. According to local electric safety regulation, the product must be equipped with the specialized power supply circuit and the air switch.
8. The air switch must be with the thermo magnetic disconnect protection function for avoiding short-circuit or overload. Please install the air switch with proper capacity.
9. Before installation, please check and confirm the special pre-embedded power supply circuit for air conditioner to make sure the pre-embedded cable complies with the requirement in the following table.

Model	Power	Connection wire of indoor unit	Power cord of outdoor unit	Air switch
30K	single phase: 208/230V 60HZ	AWG18	AWG8	50A
36K	single phase: 208/230V 60HZ	AWG18	AWG8	50A

# Installation of indoor unit

## Step one: choosing installation location

Recommend the installation location to the client and then confirm it with the client.

---

## Step two: install wall-mounting frame

1. Hang the wall-mounting frame on the wall; adjust it in horizontal position with the level meter and then point out the screw fixing holes on the wall.
  2. Drill the screw fixing holes on the wall with impact drill (the specification of drill head should be the same as the plastic expansion particle) and then fill the plastic expansion particles in the holes.
  3. Fix the wall-mounting frame on the wall with tapping screws (ST4.2X25TA) and then check if the frame is firmly installed by pulling the frame. If the plastic expansion particle is loose, please drill another fixing hole nearby.
- 

## Step three: open piping hole

1. Choose the position of piping hole according to the direction of outlet pipe. The position of piping hole should be a little lower than the wall-mounted frame, shown as below.

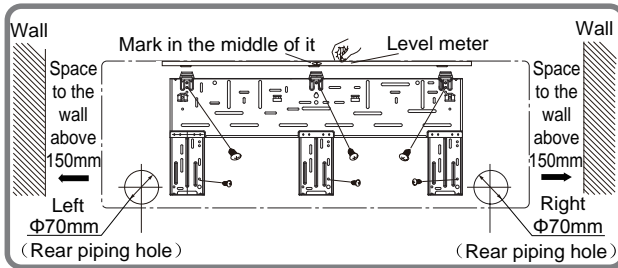

2. Open a piping hole with the diameter of Φ70 on the selected outlet pipe position. In order to drain smoothly, slant the piping hole on the wall slightly downward to the outdoor side with the gradient of 5-10°.

# Installation of indoor unit

## Note:

- Pay attention to dust prevention and take relevant safety measures when opening the hole.
- The plastic expansion particles are not provided and should be bought locally.

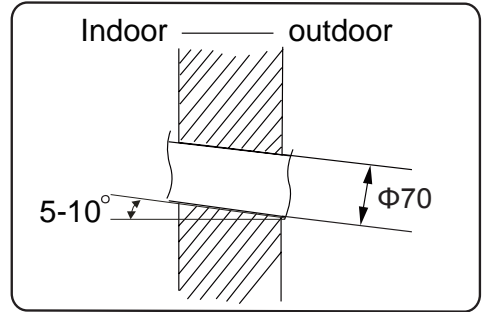

## Step four: outlet pipe

1. The pipe can be led out in the direction of right, rear right, left or rear left.

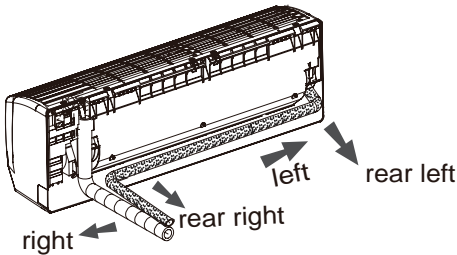

2. When select leading out the pipe from left or right, please cut off the corresponding hole on the bottom case.

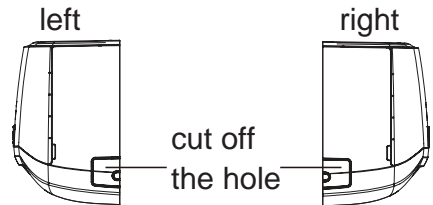

## Step five: connect the pipe of indoor unit

1. Aim the pipe joint at the corresponding bellmouth.
2. Pretightening the union nut with hand.

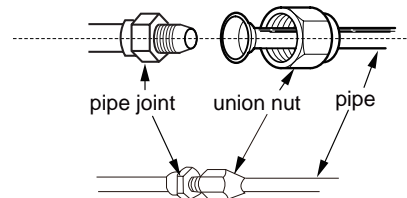

3. Adjust the torque force by referring to the following sheet. Place the open-end wrench on the pipe joint and place the torque wrench on the union nut. Tighten the union nut with torque wrench.

# Installation of indoor unit

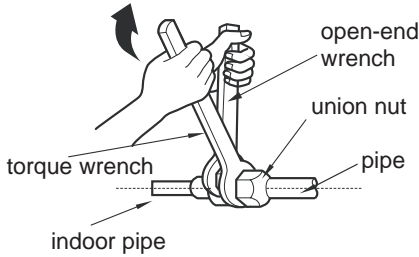

Hex nut diameter	Tightening torque (N·m)
Φ 1/4 in	15~20
Φ 3/8 in	30~40
Φ 1/2 in	45~55
Φ 5/8 in	60~65
Φ 3/4 in	70~75

4. Wrap the indoor pipe and joint of connection pipe with insulating pipe, and then wrap it with tape.

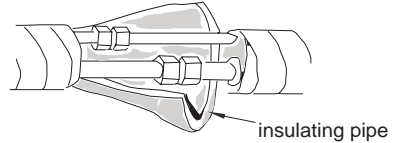

## Step six: install drain hose

1. Connect the drain hose to the outlet pipe of indoor unit.
2. Bind the joint with tape.

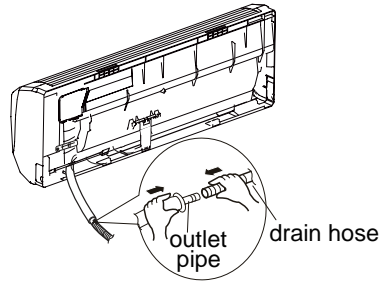
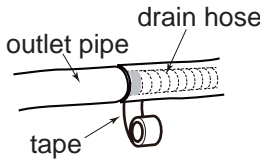

### Note:

- Add insulating pipe in the indoor drain hose in order to prevent condensation.
- The plastic expansion particles are not provided.

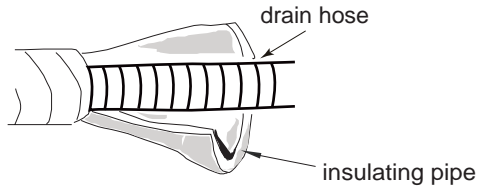

## Step seven: connect wire of indoor unit

1. Open the panel, remove the screw on the wiring cover and then take down the cover.

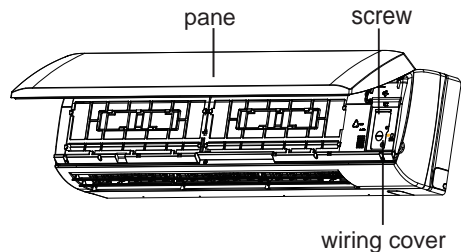

# Installation of indoor unit

2. Make the power connection wire go through the cable-cross hole at the back of indoor unit and then pull it out from the front side.

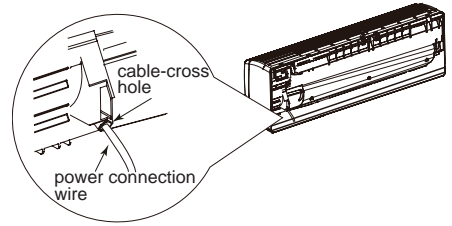

3. Remove the wire clip; connect the power connection wire to the wiring terminal according to the color; tighten the screw and then fix the power connection wire with wire clip.

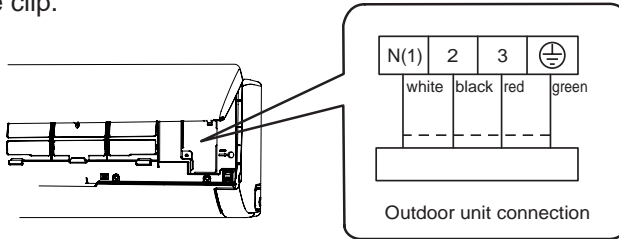

4. Put wiring cover back and then tighten the screw.
5. Close the panel.
6. Install the Conduit assy.
  - 1) Fix the conduit assy on the conduit board and then let the connection wire between indoor unit and outdoor unit go through the conduit.
  - 2) Fix the conduit assy on the chassis with 3 screws.
    - Conduit assy consists of conduit, conduit connector and lock nut.(Not the standard part, which should be purchased by customer.)
    - The length of conduit can be calculated according to the length of connection wire.

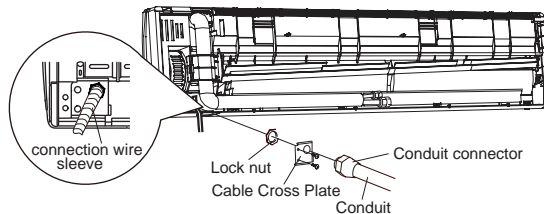

## Note:

- All wires of indoor unit and outdoor unit should be connected by a professional.
- If the length of power connection wire is insufficient, please contact the supplier for a new one. Avoid extending the wire by yourself.
- For the air conditioner with plug, the plug should be reachable after finishing installation.
- For the air conditioner without plug, an circuit break must be installed in the line. The circuit break should be all-pole parting and the contact parting distance should be more than 3mm.

# Installation of indoor unit

## Step eight: bind up pipe

1. Bind up the connection pipe, power cord and drain hose with the band.

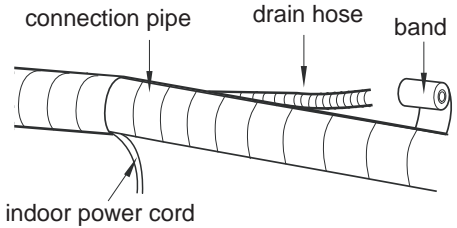
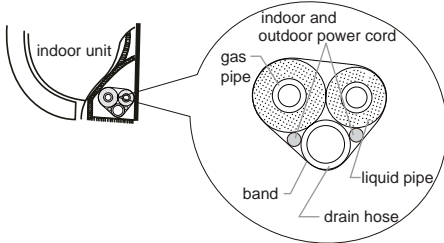

2. Reserve a certain length of drain hose and power cord for installation when binding them. When binding to a certain degree, separate the indoor power and then separate the drain hose.

indoor power cord

3. Bind them evenly.
4. The liquid pipe and gas pipe should be bound separately at the end.

Note:

- The power cord and control wire can't be crossed or winding.
- The drain hose should be bound at the bottom.

---

## Step nine: hang the indoor unit

1. Put the bound pipes in the wall pipe and then make them pass through the wall hole.
2. Hang the indoor unit on the wall-mounting frame.
3. Stuff the gap between pipes and wall hole with sealing gum.
4. Fix the wall pipe.
5. Check if the indoor unit is installed firmly and closed to the wall.

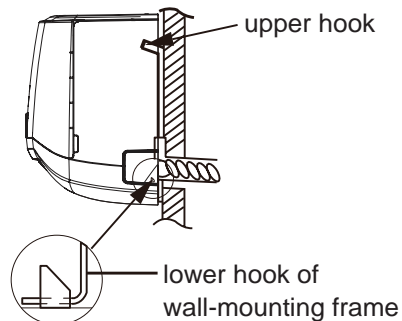
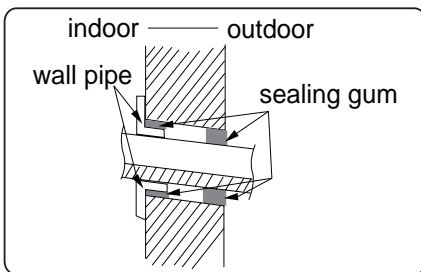

Note:

- Do not bend the drain hose too excessively in order to prevent blocking.

# Installation of outdoor unit

## Step one: fix the support of outdoor unit

(select it according to the actual installation situation)

1. Select installation location according to the house structure.
2. Fix the support of outdoor unit on the selected location with expansion screws.

### Note:

- Take sufficient protective measures when installing the outdoor unit.
- Make sure the support can withstand at least four times of the unit weight.
- The outdoor unit should be installed at least 3cm above the floor in order to install drain joint.
- For the unit with cooling capacity of 2300W ~5000W, 6 expansion screws are needed;
- for the unit with cooling capacity of 6000W ~8000W, 8 expansion screws are needed;
- for the unit with cooling capacity of 10000W ~16000W, 10 expansion screws are needed.

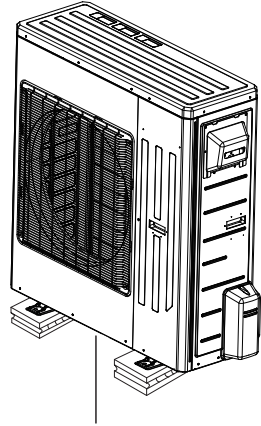

at least 3cm above the floor

## Step two: install drain joint (Only for cooling and heating unit)

1. Connect the outdoor drain joint into the hole on the chassis, as shown in the picture below.
2. Connect the drain hose into the drain vent.

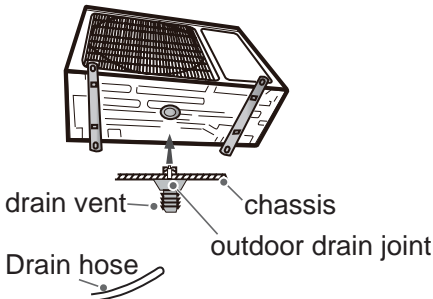

## Step three: fix outdoor unit

1. Place the outdoor unit on the support.
2. Fix the foot holes of outdoor unit with bolts.

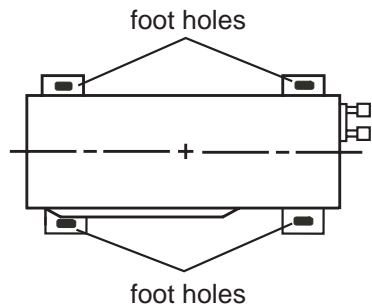

# Installation of outdoor unit

## Step four: connect indoor and outdoor pipes

1. Remove the screw cap of valve and aim the pipe joint at the bellmouth of pipe.

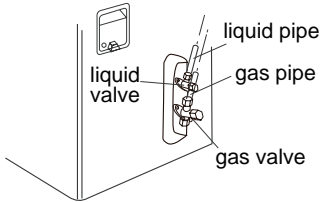

2. Pretightening the union nut with hand.

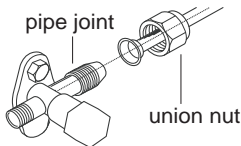

3. Tighten the union nut with torque wrench by referring to the sheet below.

Hex nut diameter	Tightening torque (N·m)
Φ 1/4 in	15~20
Φ 3/8 in	30~40
Φ 1/2 in	45~55
Φ 5/8 in	60~65
Φ 3/4 in	70~75

## Step five: connect outdoor electric wire

1. Remove the handle from the outdoor unit.
2. Fasten the power supply cord and the connection cord to the retaining plate using the lock nut. (open the knock out holes if necessary)
3. Connect the power supply cord and the connection cord to terminal.
4. Fasten the power supply cord and connection cord with cord clamp.
5. Install the handle.

The screws are packed with the terminal board.

Note: If the connection wire between indoor and outdoor is multi-core cable, the installation distance between the indoor and outdoor units is more than 20 meters, it's required to connect the wiring according to the following diagram, and ensure that the conductors connected to the "2" and "3" position of the wiring board are diagonally positioned in the cable. Otherwise, the machine may call communication error to lead the machine can't work.

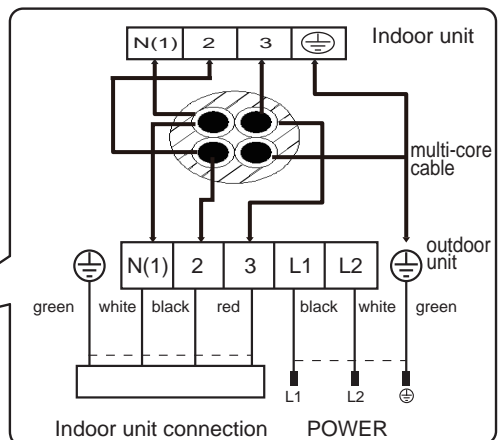
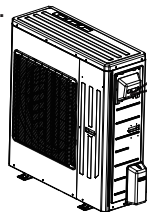
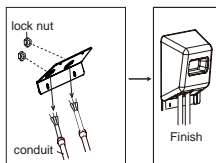



# Installation of outdoor unit

6. Fix the power connection wire and signal control wire with wire clip (only for cooling and heating unit).

## Note:

- After tighten the screw, pull the power cord slightly to check if it is firm.
- Never cut the power connection wire to prolong or shorten the distance.

## Step six: neaten the pipes

1. The pipes should be placed along the wall, bent reasonably and hidden possibly. Min. semidiameter of bending the pipe is 10cm.
2. If the outdoor unit is higher than the wall hole, you must set a U-shaped curve in the pipe before pipe goes into the room, in order to prevent rain from getting into the room.

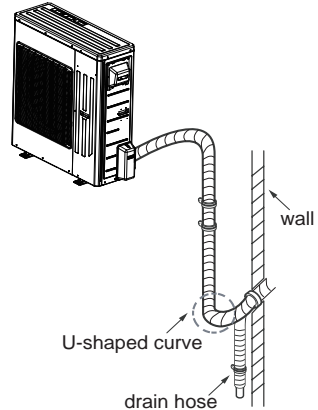

## Note:

- The through-wall height of drain hose shouldn't be higher than the outlet pipe hole of indoor unit.
- Slant the drain hose slightly downwards. The drain hose can't be curved, raised and fluctuant, etc.

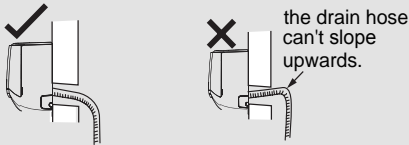

- The water outlet can't be placed in water in order to drain smoothly.

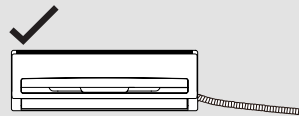
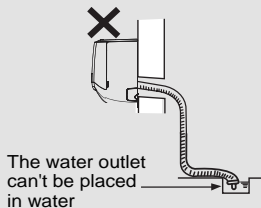

- The drain hose can't be wavy

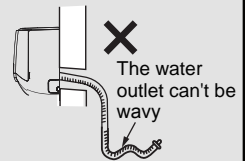
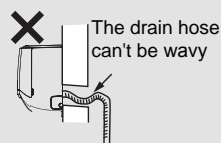

# Vacuum pumping

## Use vacuum pump

1. Remove the valve caps on the liquid valve and gas valve and the nut of refrigerant charging vent.
2. Connect the charging hose of manifold to the refrigerant charging vent of gas valve and then connect the other charging hose to the vacuum pump.
3. Open the manifold completely and operate for 15min to check if the pressure of manifold remains in  $-0.1\text{MPa}$ .
4. Close the vacuum pump and maintain this status for 2min to check if the pressure of the manifold remains in  $-0.1\text{MPa}$ . If the pressure decreases, there may be leakage.
5. Remove the manifold, open the valve core of liquid valve and gas valve completely with inner hexagon spanner.
6. Tighten the screw caps of valves and refrigerant charging vent.
7. Reinstall the handle.

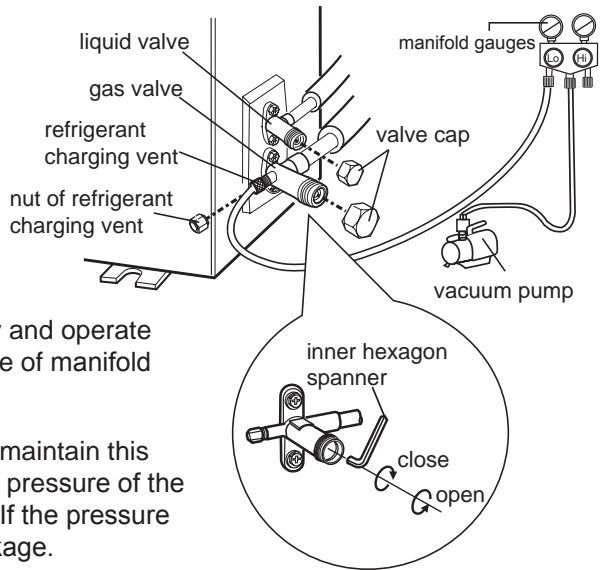

# Leakage detection

1. With leakage detector:  
Check if there is leakage with leakage detector.
2. With soap water:  
If leakage detector is not available, please use soap water for leakage detection. Apply soap water at the suspected position and keep the soap water for more than 3min. If there are air bubbles coming out of this position, there's a leakage.

## Check after installation

- Check according to the following requirement after finishing installation.

Items to be checked	Possible malfunction
Has the unit been installed firmly?	The unit may drop, shake or emit noise.
Have you done the refrigerant leakage test?	It may cause insufficient cooling (heating) capacity.
Is heat insulation of pipeline sufficient?	It may cause condensation and water dripping.
Is water drained well?	It may cause condensation and water dripping.
Is the voltage of power supply according to the voltage marked on the nameplate?	It may cause malfunction or damaging the parts.
Is electric wiring and pipeline installed correctly?	It may cause malfunction or damaging the parts.
Is the unit grounded securely?	It may cause electric leakage.
Does the power cord follow the specification?	It may cause malfunction or damaging the parts.
Is there any obstruction in the air inlet and outlet?	It may cause insufficient cooling (heating) capacity.
The dust and sundries caused during installation are removed?	It may cause malfunction or damaging the parts.
The gas valve and liquid valve of connection pipe are open completely?	It may cause insufficient cooling (heating) capacity.
Is the inlet and outlet of piping hole been covered?	It may cause insufficient cooling (heating) capacity or waster eletricity.

## Test operation

### 1. Preparation of test operation

- The client approves the air conditioner.
- Specify the important notes for air conditioner to the client.

### 2. Method of test operation

- Put through the power, press ON/OFF button on the remote controller to start operation.
- Press MODE button to select AUTO, COOL, DRY, FAN and HEAT to check whether the operation is normal or not.
- If the ambient temperature is lower than 16°C (61°F), the air conditioner can't start cooling.

# Configuration of connection pipe

1. Standard length of connection pipe

- 15 ft, 25 ft, 35 ft, 50 ft.
- Min. length of connection pipe is 10 ft.

2. Max. length of connection pipe.

Cooling capacity	Max length of connection pipe
5000Btu/h (1465W)	50
7000Btu/h (2051W)	50
9000Btu/h (2637W)	50
12000Btu/h (3516W)	65
18000Btu/h (5274W)	80

Cooling capacity	Max length of connection pipe
24000Btu/h (7032W)	80
28000Btu/h (8204W)	164
36000Btu/h (10548W)	164
42000Btu/h (12306W)	164
48000Btu/h (14064W)	164

4. The additional refrigerant oil and refrigerant charging required after prolonging connection pipe

- After the length of connection pipe is prolonged for 10m at the basis of standard length, you should add 5ml of refrigerant oil for each additional 5m of connection pipe.
- The calculation method of additional refrigerant charging amount (on the basis of liquid pipe):

Additional refrigerant charging amount = prolonged length of liquid pipe × additional refrigerant charging amount per meter

- Basing on the length of standard pipe, add refrigerant according to the requirement as shown in the table. The additional refrigerant charging amount per meter is different according to the diameter of liquid pipe. See the following sheet.

## Configuration of connection pipe

Additional refrigerant charging amount for R22, R407C, R410A and R134a

Diameter of connection pipe		Outdoor unit throttle	
Liquid pipe(in)	Gas pipe(in)	Cooling only(oz )	Cooling and heating(0z)
Φ1/4	Φ3/8 or Φ1/2	.53	.71
Φ1/4 or Φ3/8	Φ5/8 or Φ3/4	.53	1.1
Φ1/2	Φ3/4 or Φ7/8	1.1	4.23
Φ5/8	Φ1 or Φ1-1/4	2.12	4.23
Φ3/4	—	8.8	8.8
Φ7/8	—	12.35	12.35

# Pipe expanding method

## Note:

Improper pipe expanding is the main cause of refrigerant leakage. Please expand the pipe according to the following steps:

A: Cut the pipe

- Confirm the pipe length according to the distance of indoor unit and outdoor unit.
- Cut the required pipe with pipe cutter.

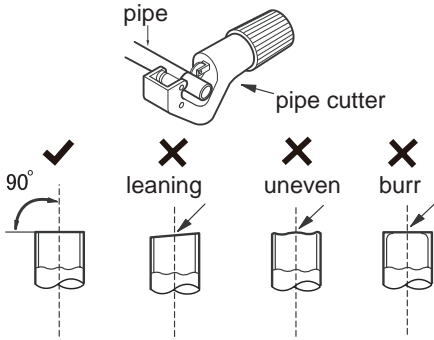

B: Remove the burrs

- Remove the burrs with shaper and prevent the burrs from getting into the pipe.

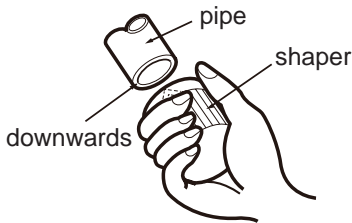

C: Put on suitable insulating pipe

D: Put on the union nut

- Remove the union nut on the indoor connection pipe and outdoor valve; install the union nut on the pipe.

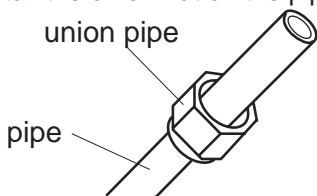

E: Expand the port

- Expand the port with expander.

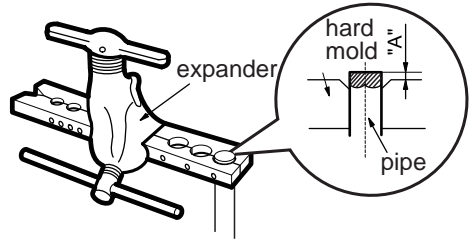

Note:

- "A" is different according to the diameter, please refer to the sheet below:

Outer diameter (mm)	A(mm)	
	Max	Min
Φ6-6.35(1/4")	1.3	0.7
Φ9.52(3/8")	1.6	1.0
Φ12-12.7(1/2")	1.8	1.0
Φ15.8-16(5/8")	2.4	2.2

F: Inspection

- Check the quality of expanding port. If there is any blemish, expand the port again according to the steps above.

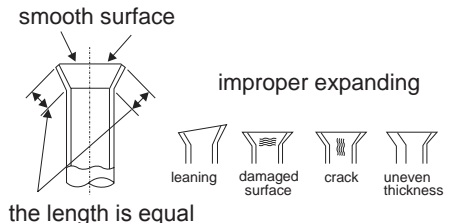



**GREE ELECTRIC APPLIANCES, INC. OF ZHUHAI**

Add: West Jinji Rd, Qianshan, Zhuhai, Guangdong, China, 519070

Tel: (+86-756) 8522218

Fax: (+86-756) 8669426

E-mail: [info@twclimate.com](mailto:info@twclimate.com)    [www.greecomfort.com](http://www.greecomfort.com)



66129930401

Cat No: GREE\_VIRU\_A\_INSTALL & OWNERS\_031519