

INSTALLATION INSTRUCTIONS

R-410A Horizontal Split System Air Conditioner

NH4A4

These instructions must be read and understood completely before attempting installation.



SAFETY CONSIDERATIONS

Improper installation, adjustment, alteration, service, maintenance, or use can cause explosion, fire, electrical shock, or other conditions which may cause death, personal injury, or property damage. Consult a qualified installer, service agency, or your distributor or branch for information or assistance. The qualified installer or agency must use factory-authorized kits or accessories when modifying this product. Refer to the individual instructions packaged with the kits or accessories when installing.

Follow all safety codes. Wear safety glasses, protective clothing, and work gloves. Use quenching cloth for brazing operations. Have a fire extinguisher available. Read these instructions thoroughly and follow all warnings or cautions included in literature and attached to the unit. Consult local building codes and the current editions of the National Electrical Code (NEC) NFPA70.

In Canada, refer to the current editions of the Canadian Electrical Code CSA C22.1.



Recognize safety information. This is the safety-alert symbol . When you see this symbol on the unit and in instructions or manuals, be alert to the potential for personal injury. Understand the signal words **DANGER**, **WARNING**, and **CAUTION**. These words are used with the safety-alert symbol. **DANGER** identifies the most serious hazards which **will** result in severe personal injury or death. **WARNING** signifies hazards which **could** result in personal injury or death. **CAUTION** is used to identify unsafe practices which **may** result in minor personal injury or product and property damage. **NOTE** is used to highlight suggestions which **will** result in enhanced installation, reliability, or operation.

TABLE OF CONTENTS

	PAGE
SAFETY CONSIDERATIONS	1
INSTALLATION	2-3
Complete Pre-Installation Checks	2
Rig and Mount Unit	2
Complete Refrigerant Piping Connections	3
Make Electrical Connections	3
START-UP	4
SERVICE	4
MAINTENANCE	6

WARNING

ELECTRICAL SHOCK HAZARD

Failure to follow this warning could result in personal injury or death.

Before installing, modifying, or servicing system, main electrical disconnect switch must be in the OFF position. There may be more than 1 disconnect switch. Lock out and tag switch with a suitable warning label.

CAUTION

ENVIRONMENTAL HAZARD

Failure to follow this caution may result in environmental pollution.

Remove and recycle all components or materials (i.e. oil, refrigerant, etc.) before unit final disposal.

INSTALLATION

IMPORTANT: Effective January 1, 2015, all split system air conditioners and heat pumps must be installed pursuant to applicable regional efficiency standards issued by the Department of Energy.

⚠ CAUTION

CUT HAZARD

Failure to follow this caution may result in personal injury. Sheet metal parts may have sharp edges or burrs. Use care and wear appropriate protective clothing and gloves when handling parts.

⚠ WARNING

UNIT OPERATION AND SAFETY HAZARD

Failure to follow this warning could result in personal injury or equipment damage. R-410A refrigerant systems operate at higher pressures than standard R-22 systems. Do not use R-22 service equipment or components on R-410A refrigerant equipment.

⚠ CAUTION

PERSONAL INJURY AND EQUIPMENT DAMAGE HAZARD

Failure to follow this caution may result in personal injury and / or equipment damage. **DO NOT** operate the unit without a filter or with grille removed.

COMPLETE PRE-INSTALLATION CHECKS

Unpack Unit

Move the unit to final location. Remove unit from carton, being careful not to damage service valves and grilles.

Inspect Shipment

File a claim with the shipping company if shipment is damaged or incomplete. Check the unit nameplates to ensure units match job requirements.

Consider System Requirements

Consult local building codes and NEC for special installation requirements.

Allow sufficient space for airflow clearance, wiring, refrigerant piping, and servicing unit. Locate unit so that condenser airflow is unrestricted on both sides.

Unit may be mounted on a level pad directly on base legs or mounted on raised pads at support points.

RIG AND MOUNT UNIT

Mounting on Ground

Mount unit on a solid, level concrete pad. Position unit so water or ice from roof does not fall directly onto unit. Use field-provided snow stand or ice rack where prolonged subfreezing temperatures or heavy snow occurs.

If conditions or local codes require unit be fastened to a pad, 6 field-supplied tie-down bolts should be used and fastened through slots provided in unit mounting feet.

Mounting on Roof

Mount unit on a level platform or frame at least 6 in. (152.4 mm) above roof surface. Isolate unit and tubing from structure.

Clearance Requirements

With coil facing wall: Allow 6" (152.4 mm) minimum clearance on coil side and coil end and 20" (504.0 mm) minimum clearance on fan side. Allow 24" (609.6 mm) minimum clearance on compressor end for service.

With fan facing wall: Allow 8" (203.2 mm) minimum clearance on coil side and coil end and 20" (504.0 mm) minimum clearance on fan side. Allow 24" (609.6 mm) minimum clearance on compressor end for service.

With multi-unit application: Allow 24" (609.6 mm) minimum clearance between multiple units. Arrange units so discharge of one does not enter inlet of another.

IMPORTANT: When installing multiple units, ensure the discharge air from one unit is not drawn into another unit. When installing single or multiple units in an alcove, roof well, or partially enclosed area, ensure there is adequate ventilation to prevent recirculation of discharge air.

Operating Ambient

Minimum outdoor operating ambient in cooling mode is 55°F (13°C), maximum 125°F (52°C).

Rigging

⚠ CAUTION

PERSONAL INJURY AND/OR EQUIPMENT DAMAGE HAZARD

Failure to follow this caution may result in personal injury and/or equipment damage.

Be sure unit panels are securely in place prior to rigging.

Keep the unit upright and lift unit using a sling. Use cardboard or padding under the sling, and spreader bars to prevent sling damage to the unit. See Fig. 1. Install the unit so that the coil does not face into prevailing winds. If this is not possible and constant winds above 25 mph are expected, use accessory wind baffle. See installation instructions provided with the accessory kit.

NOTE: Accessory wind baffles should be used on all units with accessory low ambient temperature control.

Field-fabricated snow or ice stands may be used to raise unit when operation will be required during winter months. Units may also be wall mounted using the accessory wall mounting kit.

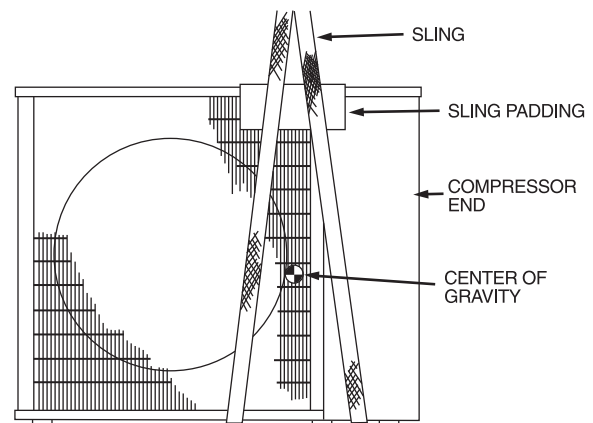

Fig. 1 – Lifting Unit with Sling

A07396

COMPLETE REFRIGERANT PIPING CONNECTIONS

Outdoor units may be connected to indoor units using field-supplied tubing of refrigerant grade and condition. See Specification Sheet for correct line sizes. Do not use less than 10 ft (3.05 m) of interconnecting tubing.



CAUTION

UNIT DAMAGE HAZARD

Failure to follow this caution may result in equipment damage or improper operation.

If any section of pipe is buried, there must be a 6 in. (152.4 mm) vertical rise to the valve connections on the outdoor unit. If more than the recommended length is buried, refrigerant may migrate to cooler, buried section during extended periods of system shutdown. This causes refrigerant slugging and could possibly damage the compressor at start-up.

When more than 80 ft (24.4 m) of interconnecting tubing and more than 20 ft (6.1 m) of vertical lift is used, consult the residential Long Line Application Guide for required accessories. If either refrigerant tubing or indoor coil is exposed to the atmosphere, the system must be evacuated following good refrigeration practices.

Run refrigerant tubes as directly as possible, avoiding unnecessary turns and bends. Suspend refrigerant tubes so they do not damage insulation on vapor tube and do not transmit vibration to structure. Also, when passing refrigerant tubes through a wall, seal the opening so that vibration is not transmitted to structure. Leave some slack in refrigerant tubes between structure and outdoor unit to absorb vibration. Refer to separate indoor unit installation instructions for additional information.

Filter Drier

Refer to Fig. 2 and install filter drier as follows:

1. Braze 5 in. (127 mm) liquid tube to the indoor coil.
2. Wrap filter drier with damp cloth.
3. Braze filter drier to 5 in. (127 mm) long liquid tube from step 1.
4. Connect and braze liquid refrigerant tube to the filter drier.

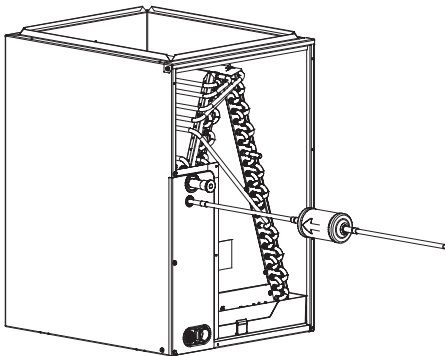

Fig. 2 – Filter Drier Components

A05178

The filter drier must be replaced whenever the refrigeration system is exposed to the atmosphere.

Only use factory specified liquid-line filter driers with rated working pressures less than 600 psig.

NOTE: Do not install a suction-line filter drier in liquid line.

Make Piping Sweat Connections



WARNING



EXPLOSION HAZARD

Failure to follow this warning could result in death, serious personal injury, and/or property damage.

Never use air or gases containing oxygen for leak testing or operating refrigerant compressors. Pressurized mixtures of air or gases containing oxygen can lead to an explosion.

Remove plastic caps from liquid and suction service valves. Use refrigerant grade tubing. Service valves are closed from the factory and are ready for brazing. After wrapping the service valve with a wet cloth, the tubing set can be brazed to the service valve using either silver bearing or non-silver bearing brazing material. Consult local code requirements. Refrigerant tubing and the indoor coil are now ready for leak testing.

NOTE: Unit is shipped with R-410A refrigerant factory charge indicated on nameplate.

Pass nitrogen or other inert gas through piping while brazing to prevent formation of copper oxide.



CAUTION

UNIT DAMAGE HAZARD

Failure to follow this caution may result in equipment damage or improper operation.

To prevent damage to unit or service valves observe the following:

- Use a brazing shield.
- Wrap service valves with wet cloth or use a heat sink material.

MAKE ELECTRICAL CONNECTIONS



WARNING

ELECTRICAL SHOCK HAZARD

Failure to follow this warning could result in personal injury or death.

The unit cabinet must have an uninterrupted or unbroken ground to minimize personal injury if an electrical fault should occur. The ground may consist of electrical wire or metal conduit when installed in accordance with existing electrical codes.



CAUTION

UNIT DAMAGE HAZARD

Failure to follow this caution may result in equipment damage or improper operation.

Unit failure as a result of operation on improper line voltage or excessive phase imbalance constitutes abuse and may cause damage to electrical components. Such operation would void any applicable warranty.



WARNING

ELECTRICAL SHOCK HAZARD

Failure to follow this warning could result in personal injury or death.

Before performing service or maintenance, be sure indoor unit main power switch is turned OFF and indoor blower has stopped.

Power Wiring

Unit is factory wired for voltage shown on nameplate. Provide adequate, fused disconnect switch within sight from unit, readily accessible, but out of reach of children. Provision for locking the switch open (off) is advisable to prevent power from being turned on while unit is being serviced.

Disconnect switch, fuses, and field wiring must comply with the NEC and local code requirements. Use copper wire only between the disconnect switch and unit. Use minimum 75 C wire for the field power connection.

Route power wires through the opening in unit side panel and connect in the unit control box as shown on the unit label diagram and Fig. 3. Unit must be grounded.

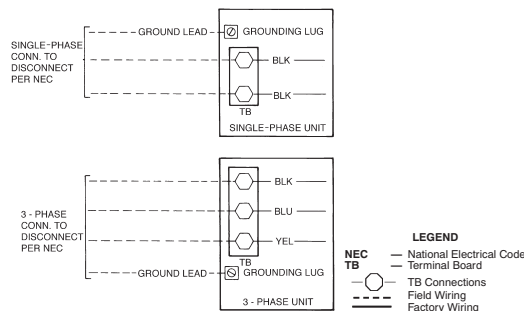

Fig. 3 – Line Power Connections

A07428

Control Circuit Wiring

Control voltage is 24 v (40 va minimum). See Fig. 4 and unit label diagram for field-supplied wiring details. Route control wire through opening in unit side panel to connection in unit control box.

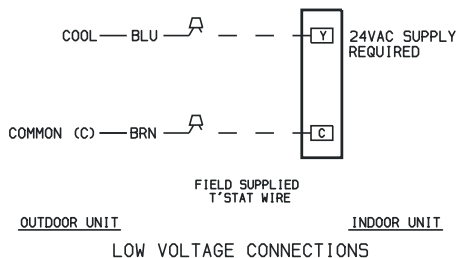

Fig. 4 – NH4A4 Typical Control Circuit Connections

A07398

NOTE: Use No. 18 AWG color-coded, insulated (35°C minimum) wire. If thermostat is located more than 100 ft. (30.5 m) from unit, as measured along the control voltage wires, use No. 16 AWG color-coded wire to avoid excessive voltage drop.

NOTE: All wiring must conform to NEC and local codes.

NOTE: Operating unit on improper line voltage constitutes abuse and could affect warranty. See Specification Sheet. **Do not** install unit in a system where voltage may fluctuate above or below permissible limits.

Refer to the Specification Sheet for recommended fuse sizes. When making electrical connections, provide clearance at the unit for refrigerant piping connections.

NOTE: The NH4A4 units use the control transformer supplied with the matched indoor unit.

START-UP

PRELIMINARY CHECKS

1. Check that all internal wiring connections are tight and that all barriers, covers, and panels are in place.
2. Field electrical power source must agree with unit name-plate rating.
3. All service valves must be open.
4. Belly-band crankcase heater must be tight on compressor crankcase for those units with belly-band heaters.

EVACUATE AND DEHYDRATE

Field piping and fan coil must be evacuated and dehydrated.

CHARGE SYSTEM

Release charge into system by opening (back-seating) liquid and suction line service valves. Outdoor unit is charged for 15 ft (4.6 m) of 3/8-in. liquid line.

TO START UNIT

Be sure that the field disconnect is closed. Set room thermostat below ambient temperature. Operate unit for 15 minutes, then check system refrigerant charge. See Refrigerant Charging section.

SERVICE



WARNING

ELECTRICAL SHOCK HAZARD

Failure to follow this warning could result in personal injury or death.

Before installing, modifying, or servicing system, main electrical disconnect switch must be in the OFF position. There may be more than 1 disconnect switch. Lock out and tag switch with a suitable warning label.

High-Pressure Relief Valve

The high-pressure relief valve is located in the compressor. The relief valve opens at a pressure differential of approximately 550 to 625 ± 50 psig between suction (low side) and discharge (high side) to allow pressure equalization.

Internal Current and Temperature Sensitive Overload

The control resets automatically when internal compressor motor temperature drops to a safe level (overloads may require up to 45 minutes to reset). When an internal overload is suspected of being open, check by using an ohmmeter or continuity tester.

Pumpdown Procedure

The system may be pumped down in order to make repairs on the low side without losing complete refrigerant charge.



CAUTION

UNIT DAMAGE HAZARD

Failure to follow this caution may result in equipment damage or improper operation.

Never open system to atmosphere while it is under a vacuum.

When system must be opened for service, recover refrigerant, break vacuum with dry nitrogen before opening system.

1. Attach pressure gage to suction service valve gage port.
2. Front-seat the liquid/mixed phase line valve.



CAUTION

UNIT DAMAGE HAZARD

Failure to follow this caution may result in equipment damage or improper operation.

The unit coils hold only the factorydesignated amount of refrigerant. Additional refrigerant may cause units to relieve pressure through the compressor internal pressure relief valve (indicated by a sudden rise of suction pressure) before suction pressure reaches 20 psig. If this occurs, shut off unit immediately then front-seat the suction valve and remove and recover excess refrigerant following accepted practices

3. Start unit and run until suction pressure reaches 20 psig.
4. Shut unit off and front-seat suction valve.
5. De-pressurize low side of unit and recover refrigerant following accepted practices.

Crankcase Heater

The crankcase heater prevents refrigerant migration and compressor oil dilution during shutdown when compressor is not operating. If the crankcase heater is de-energized for more than 6 hours, both compressor service valves must be closed.

NOTE: Addition of an accessory crankcase heater is required for long line and low ambient colling applications. Refer to the Residential Long Line Guideline.

The crankcase heater is powered by the high-voltage power of the unit. It is connected across the line side of the contactor and is thermostatically controlled.



WARNING

PERSONAL INJURY HAZARD

Failure to follow this warning could result in personal injury or death.

Use extreme caution when troubleshooting this device as line voltage is continually present.

To troubleshoot:

1. Apply voltmeter across crankcase heater leads to see if heater voltage is on. Do not touch heater. Carefully feel area around crankcase heater; if warm, crankcase heater is functioning.
2. With power off and heater leads disconnected, check across leads with ohmmeter. Do not look for a specific resistance reading. Check for resistance or an open circuit, and change heater if an open circuit is detected.

Service Valves

The service valves in the outdoor unit come from the factory front-seated. This means the refrigerant charge is isolated from the line-set connection ports. To prevent damage to the valve, use a wet cloth or other accepted heat sink material on the valve before brazing.

The service valve cannot be field repaired, therefore, only a complete valve or valve stem seal and service port caps are available for replacement.

Refrigerant Charging



WARNING

PERSONAL INJURY AND/OR EQUIPMENT DAMAGE HAZARD

Failure to follow this warning could result in personal injury and/or equipment damage.

Wear safety glasses and gloves when handling refrigerant. Do not overcharge system - this can cause compressor flooding.



WARNING

PERSONAL INJURY AND/OR EQUIPMENT DAMAGE HAZARD

Failure to follow this warning could result in personal injury and/or equipment damage.

Service valves must be fully back-seated to close service port. There is no Schrader valve at the service port, and failure to back-seat the valve could result in loss of system charge or personal injury.

NOTE: Do not vent or de-pressurize unit refrigerant to atmosphere. Remove and recover refrigerant following accepted practices.

All units are shipped with the refrigerant charge listed on the nameplate.

Refer to Specification Sheet and consider the following when working with R-410A refrigerant:

- R-410A refrigerant cylinders are rose colored.
- Recovery cylinder service pressure rating must be 400 psig, DOT (Department of Transportation) 4BA400 or DOT BW400.
- R-410A systems should be charged with liquid refrigerant. Use a commercial type metering device in the manifold hose when charging into suction line with compressor operating.
- Manifold sets should be 700 psig high side and 180 psig low side with 550 psig low-side retard.
- Use hoses with 700 psig service pressure rating.
- R-410A refrigerant, as with other HFCs, is only compatible with POE oils.
- Vacuum pumps will not remove moisture from oil.
- Polyol Ester oils absorb moisture rapidly. Do not expose oil to atmosphere.
- Polyol Ester oils may cause damage to certain plastics and roofing materials.
- Wrap all filter driers and service valves with wet cloth when brazing.
- factory approved, liquid-line filter drier is required on every unit.
- Do not use a TXV (thermostatic expansion valve) designed for use with R-22 refrigerant. Refer to separate indoor unit installation instructions for more details.
- If using a suction line drier, do not leave in place for more than 72 hours.

35 ft. (10.6 m) - 25 ft. (7.6 m) = 10 ft. X 0.6 oz./ft. = 6 oz. of additional charge.

CHECK CHARGE

Charging method is shown on information plate inside unit. To properly check or adjust charge, conditions must be favorable for subcooling charging. Favorable conditions exist when the outdoor temperature is between 70°F and 100°F (21.11°C and 37.78°C), and the indoor temperature is between 70°F and 80°F (21.11°C and 26.67°C). Follow the procedure below:

Unit is factory charged for 15ft (4.57 m) of lineset. Adjust charge by adding or removing 0.6 oz/ft (.018 kg/m) of 3/8 liquid line above or below 15ft (4.57 m) respectively.

For standard refrigerant line lengths (80 ft/24.38 m or less), allow system to operate in cooling mode at least 15 minutes. If conditions are favorable, check system charge by subcooling method. If any adjustment is necessary, adjust charge slowly and allow system to operate for 15 minutes to stabilize before declaring a properly charged system.

If the indoor temperature is above 80°F (26.67°C), and the outdoor temperature is in the favorable range, adjust system charge by weight based on line length and allow the indoor temperature to drop to 80°F (26.67°C) before attempting to check system charge by subcooling method as described above.

If the indoor temperature is below 70°F (21.11°C), or the outdoor temperature is not in the favorable range, adjust charge for line set length above or below 15ft (4.57 m) only. Charge level should then be appropriate for the system to achieve rated capacity. The charge level could then be checked at another time when the both indoor and outdoor temperatures are in a more favorable range.

NOTE: If line length is beyond 80 ft (24.38 m) or greater than 20 ft (6.10 m) vertical separation, See Residential Piping and Long Line Guideline for special charging requirements.

MAINTENANCE



WARNING

ELECTRICAL SHOCK HAZARD

Failure to follow this warning could result in personal injury or death.

Before installing, modifying, or servicing system, main electrical disconnect switch must be in the OFF position. There may be more than 1 disconnect switch. Lock out and tag switch with a suitable warning label.

LUBRICATION

Compressor

Compressor contains factory oil charge; replace oil when lost. Use Mobile 3MA-POE oil.

CLEANING COILS

Coil should be washed out with water or blown out with compressor air. Note that the blow-thru design causes dirt and debris to build up on the inside of the coils. Clean coil annually or as required by location and outdoor air conditions. Inspect coil monthly and clean as required. Fins are not continuous through coil sections. Dirt and debris may pass through first section, become trapped between the row of fins and restrict condenser airflow. Use a flashlight to determine if dirt or debris has collected between coil sections. Clean coil as follows:

1. Turn off unit power.
2. Using a garden hose or other suitable equipment, flush coil from the outside to remove dirt. Be sure to flush all dirt and debris from drain holes in base of unit. Fan motors are waterproof.