

Service Manual

Inverter Pair
Wall Mounted Type FTX-N/U Series
Floor Standing Type FVXS-V Series
Duct Connected Type FDMQ-R Series

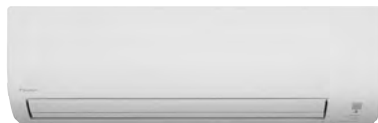
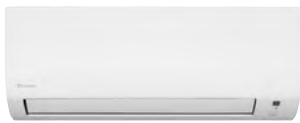

[Applied Models]

● Inverter Pair : Heat Pump

Introduction	1
1. Safety Cautions	2
1.1 Warnings and Cautions Regarding Safety of Workers	2
1.2 Warnings and Cautions Regarding Safety of Users	4
2. Icons Used	7
3. Revision History	8
Part 1 General Information	9
1. Applicable Models	10
2. Functions.....	11
Part 2 Specifications	13
1. Specifications	14
Part 3 Printed Circuit Board Connector Wiring Diagram.....	21
1. Indoor Unit.....	22
1.1 FTX09/12NMVJU	22
1.2 FTX15NMVJU	24
1.3 FTX18/24UVJU	26
1.4 FVXS09/12/15NVJU.....	28
1.5 FDMQ12/18/24RVJU	30
2. Wireless Remote Controller Receiver	32
2.1 BRC082A43	32
3. Wired Remote Controller.....	33
3.1 BRC1E73	33
4. Outdoor Unit.....	34
4.1 RXL09QMVJU.....	34
4.2 RXL12QMVJU(9)	36
4.3 RXL15QMVJU.....	38
4.4 RXL18/24UMVJU	39
5. Optional Adaptor	42
5.1 BRP072A43 Wireless LAN Adaptor	42
5.2 KRP067A41/KRP980B2 Remote Control PC-board Set.....	42
Part 4 Functions and Control	43
1. Common Functions	44
1.1 Temperature Control	44
1.2 Frequency Principle.....	44
2. Functions for FTX, FVXS Series	46
2.1 Airflow Direction Control.....	46
2.2 COMFORT AIRFLOW Operation	49
2.3 Fan Speed Control for Indoor Unit	50
2.4 Program Dry Operation	51
2.5 Automatic Cooling/Heating Changeover	52

2.6	Thermostat Control.....	53
2.7	NIGHT SET Mode	54
2.8	ECONO Operation	55
2.9	INTELLIGENT EYE Operation	56
2.10	POWERFUL Operation	57
2.11	Clock Setting	58
2.12	WEEKLY TIMER Operation	59
2.13	Other Functions.....	65
3.	Functions for FDMQ Series.....	66
3.1	Fan Speed Control for Indoor Unit	66
3.2	Program Dry Operation	67
3.3	Clock and Calender Setting (With BRC1E73).....	68
3.4	Schedule Timer Operation (With BRC1E73).....	70
3.5	Drain Pump Control.....	73
3.6	Hot Start Control (In Heating Operation Only).....	75
3.7	Other Functions.....	76
4.	Thermistor Functions	77
5.	Control Specification	78
5.1	Mode Hierarchy	78
5.2	Frequency Control.....	78
5.3	Controls at Mode Changing/Start-up.....	80
5.4	Discharge Pipe Temperature Control.....	82
5.5	Input Current Control.....	83
5.6	Freeze-up Protection Control	84
5.7	Heating Peak-cut Control	84
5.8	Outdoor Fan Control.....	85
5.9	Liquid Compression Protection Function.....	85
5.10	Defrost Control	86
5.11	Electronic Expansion Valve Control	87
5.12	Malfunctions	90

Part 5 Remote Controller 91

1.	Applicable Remote Controller	92
2.	ARC466A21	93
3.	ARC466A37	95
4.	ARC480A8	97
5.	BRC082A43	98
6.	BRC1E73	100

Part 6 Service Diagnosis 106

1.	General Problem Symptoms and Check Items	108
2.	Troubleshooting with LED	109
2.1	Indoor Unit.....	109
2.2	Outdoor Unit.....	110
3.	Service Diagnosis	111
3.1	ARC480 Series.....	111

3.2	ARC466 Series.....	114
3.3	BRC1E73	117
3.4	BRC082A43	119
4.	Error Codes and Description.....	123
5.	Troubleshooting for FTX, FVXS Series.....	124
5.1	Indoor Unit PCB Abnormality	124
5.2	Freeze-up Protection Control/Heating Peak-cut Control	126
5.3	Indoor Fan Motor (DC Motor) or Related Abnormality	128
5.4	Thermistor or Related Abnormality.....	132
5.5	Low-voltage Detection or Over-voltage Detection.....	133
5.6	Signal Transmission Error (Between Indoor Unit and Outdoor Unit).....	135
5.7	Unspecified Voltage (Between Indoor Unit and Outdoor Unit).....	137
6.	Troubleshooting for FDMQ Series	138
6.1	Indoor Unit PCB Abnormality	138
6.2	Drain Level Control System Abnormality.....	139
6.3	Indoor Fan Motor (DC Motor) or Related Abnormality	140
6.4	Indoor Fan PCB Abnormality.....	142
6.5	Humidifier or Related Abnormality.....	143
6.6	Thermistor or Related Abnormality.....	144
6.7	Remote Controller Thermistor Abnormality	145
6.8	Low-voltage Detection or Over-voltage Detection.....	146
6.9	Signal Transmission Error (Between Indoor and Outdoor Unit).....	148
6.10	Signal Transmission Error (Between Indoor Unit and Remote Controller)	150
6.11	Signal Transmission Error (Between MAIN/SUB Remote Controllers)	151
6.12	Mismatching of Indoor Unit and Outdoor Unit	152
7.	Troubleshooting for Outdoor Unit.....	153
7.1	Outdoor Unit PCB Abnormality.....	153
7.2	OL Activation (Compressor Overload)	154
7.3	Compressor Lock	157
7.4	DC Fan Lock	158
7.5	Input Overcurrent Detection	159
7.6	Four Way Valve Abnormality.....	161
7.7	Discharge Pipe Temperature Control.....	163
7.8	High Pressure Control in Cooling	165
7.9	System Shutdown due to Temperature Abnormality in the Compressor	167
7.10	Compressor Sensor System Abnormality	168
7.11	Position Sensor Abnormality	169
7.12	Thermistor or Related Abnormality (Outdoor Unit).....	172
7.13	Electrical Box Temperature Rise	174
7.14	Radiation Fin Temperature Rise	176
7.15	Output Overcurrent Detection	178
7.16	Signal Transmission Error on Outdoor Unit PCB	180
8.	Check	181
8.1	Thermistor Resistance Check	181
8.2	Indoor Fan Motor Connector Check.....	182
8.3	Power Supply Waveform Check.....	184

8.4	Electronic Expansion Valve Check.....	184
8.5	Four Way Valve Performance Check.....	185
8.6	Inverter Unit Refrigerant System Check.....	185
8.7	Inverter Analyzer Check.....	186
8.8	Rotation Pulse Check on the Outdoor Unit PCB.....	189
8.9	Installation Condition Check.....	190
8.10	Discharge Pressure Check.....	190
8.11	Outdoor Fan System Check.....	191
8.12	Main Circuit Short Check.....	191
8.13	Power Module Check.....	194

Part 7 Trial Operation and Field Settings..... 197

1.	Pump Down Operation.....	198
2.	Forced Cooling Operation.....	199
3.	Trial Operation.....	202
4.	Field Settings for FTX, FVXS Series.....	206
4.1	Temperature Display Switch.....	206
4.2	When 2 Units are Installed in 1 Room.....	207
4.3	Jumper and Switch Settings.....	209
5.	Field Settings for FDMQ Series.....	210
5.1	How to Change the Field Settings.....	210
5.2	Overview of Field Settings.....	213
5.3	MAIN/SUB and Address Setting for Wireless Remote Controller.....	214
6.	Field Settings for Outdoor Unit.....	217
6.1	Facility Setting (cooling at low outdoor temperature).....	217
6.2	Drain Pan Heater.....	218
7.	Silicone Grease on Power Transistor/Diode Bridge.....	219

Part 8 Appendix..... 220

1.	Piping Diagrams.....	221
1.1	Indoor Unit.....	221
1.2	Outdoor Unit.....	223
2.	Wiring Diagrams.....	226
2.1	Indoor Unit.....	226
2.2	Outdoor Unit.....	231
3.	Operation Limit.....	236

Introduction

1. Safety Cautions.....	2
1.1 Warnings and Cautions Regarding Safety of Workers.....	2
1.2 Warnings and Cautions Regarding Safety of Users.....	4
2. Icons Used	7
3. Revision History	8

1. Safety Cautions

Be sure to read the following safety cautions before conducting repair work.

After the repair work is complete, be sure to conduct a test operation to ensure that the equipment operates normally, and explain the cautions for operating the product to the customer.

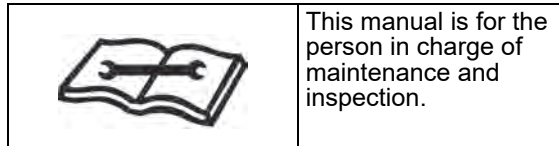







Caution Items







The caution items are classified into **Warning** and **Caution**. The **Warning** items are especially important since death or serious injury can result if they are not followed closely. The **Caution** items can also lead to serious accidents under some conditions if they are not followed. Therefore, be sure to observe all the safety caution items described below.







Pictograms



- △ This symbol indicates an item for which caution must be exercised. The pictogram shows the item to which attention must be paid.
- This symbol indicates a prohibited action. The prohibited item or action is shown in the illustration or near the symbol.
- This symbol indicates an action that must be taken, or an instruction. The instruction is shown in the illustration or near the symbol.

1.1 Warnings and Cautions Regarding Safety of Workers









 Warning	
<p>Do not store equipment in a room with fire sources (e.g., naked flames, gas appliances, electric heaters).</p>	
<p>Be sure to disconnect the power cable from the socket before disassembling equipment for repair. Working on equipment that is connected to the power supply may cause an electrical shock. If it is necessary to supply power to the equipment to conduct the repair or inspect the circuits, do not touch any electrically charged sections of the equipment.</p>	
<p>If refrigerant gas is discharged during repair work, do not touch the discharged refrigerant gas. Refrigerant gas may cause frostbite.</p>	
<p>When disconnecting the suction or discharge pipe of the compressor at the welded section, evacuate the refrigerant gas completely at a well-ventilated place first. If there is gas remaining inside the compressor, the refrigerant gas or refrigerating machine oil discharges when the pipe is disconnected, and it may cause injury.</p>	
<p>If refrigerant gas leaks during repair work, ventilate the area. Refrigerant gas may generate toxic gases when it contacts flames.</p>	







 Warning	
<p>Be sure to discharge the capacitor completely before conducting repair work. The step-up capacitor supplies high-voltage electricity to the electrical components of the outdoor unit. A charged capacitor may cause an electrical shock.</p>	
<p>Do not turn the air conditioner on or off by plugging in or unplugging the power cable. Plugging in or unplugging the power cable to operate the equipment may cause an electrical shock or fire.</p>	
<p>Be sure to wear a safety helmet, gloves, and a safety belt when working in a high place (more than 2 m (6.5 ft)). Insufficient safety measures may cause a fall.</p>	
<p>In case of R-32 / R-410A refrigerant models, be sure to use pipes, flare nuts and tools intended for the exclusive use with the R-32 / R-410A refrigerant. The use of materials for R-22 refrigerant models may cause a serious accident, such as a damage of refrigerant cycle or equipment failure.</p>	
<p>Do not mix air or gas other than the specified refrigerant (R-32 / R-410A / R-22) in the refrigerant system. If air enters the refrigerant system, an excessively high pressure results, causing equipment damage and injury.</p>	







 Caution	
<p>Do not repair electrical components with wet hands. Working on the equipment with wet hands may cause an electrical shock.</p>	
<p>Do not clean the air conditioner with water. Washing the unit with water may cause an electrical shock.</p>	
<p>Be sure to provide an earth / grounding when repairing the equipment in a humid or wet place, to avoid electrical shocks.</p>	
<p>Be sure to turn off the power switch and unplug the power cable when cleaning the equipment. The internal fan rotates at a high speed, and may cause injury.</p>	
<p>Be sure to conduct repair work with appropriate tools. The use of inappropriate tools may cause injury.</p>	





 Caution	
<p>Be sure to check that the refrigerating cycle section has cooled down enough before conducting repair work. Working on the unit when the refrigerating cycle section is hot may cause burns.</p>	
<p>Conduct welding work in a well-ventilated place. Using the welder in an enclosed room may cause oxygen deficiency.</p>	

1.2 Warnings and Cautions Regarding Safety of Users

 Warning	
<p>Do not store the equipment in a room with fire sources (e.g., naked flames, gas appliances, electric heaters).</p>	
<p>Be sure to use parts listed in the service parts list of the applicable model and appropriate tools to conduct repair work. Never attempt to modify the equipment. The use of inappropriate parts or tools may cause an electrical shock, excessive heat generation or fire.</p>	
<p>If the power cable and lead wires are scratched or have deteriorated, be sure to replace them. Damaged cable and wires may cause an electrical shock, excessive heat generation or fire.</p>	
<p>Do not use a joined power cable or extension cable, or share the same power outlet with other electrical appliances, since it may cause an electrical shock, excessive heat generation or fire.</p>	
<p>Be sure to use an exclusive power circuit for the equipment, and follow the local technical standards related to the electrical equipment, the internal wiring regulations, and the instruction manual for installation when conducting electrical work. Insufficient power circuit capacity and improper electrical work may cause an electrical shock or fire.</p>	
<p>Be sure to use the specified cable for wiring between the indoor and outdoor units. Make the connections securely and route the cable properly so that there is no force pulling the cable at the connection terminals. Improper connections may cause excessive heat generation or fire.</p>	
<p>When wiring between the indoor and outdoor units, make sure that the terminal cover does not lift off or dismount because of the cable. If the cover is not mounted properly, the terminal connection section may cause an electrical shock, excessive heat generation or fire.</p>	
<p>Do not damage or modify the power cable. Damaged or modified power cables may cause an electrical shock or fire. Placing heavy items on the power cable, or heating or pulling the power cable may damage it.</p>	





 Warning	
<p>Do not mix air or gas other than the specified refrigerant (R-32 / R-410A / R-22) in the refrigerant system. If air enters the refrigerant system, an excessively high pressure results, causing equipment damage and injury.</p>	
<p>If the refrigerant gas leaks, be sure to locate the leaking point and repair it before charging the refrigerant. After charging the refrigerant, make sure that there is no leak. If the leaking point cannot be located and the repair work must be stopped, be sure to pump-down, and close the service valve, to prevent refrigerant gas from leaking into the room. Refrigerant gas itself is harmless, but it may generate toxic gases when it contacts flames, such as those from fan type and other heaters, stoves and ranges.</p>	
<p>When relocating the equipment, make sure that the new installation site has sufficient strength to withstand the weight of the equipment. If the installation site does not have sufficient strength or the installation work is not conducted securely, the equipment may fall and cause injury.</p>	
<p>Check to make sure that the power cable plug is not dirty or loose, then insert the plug into a power outlet securely. If the plug is dusty or has a loose connection, it may cause an electrical shock or fire.</p>	
<p>When replacing the coin battery in the remote controller, be sure to dispose of the old battery to prevent children from swallowing it. If a child swallows the coin battery, see a doctor immediately.</p>	

 Caution	
<p>Installation of a leakage breaker is necessary in some cases depending on the conditions of the installation site, to prevent electrical shocks.</p>	
<p>Do not install the equipment in a place where there is a possibility of combustible gas leaks. If combustible gas leaks and remains around the unit, it may cause a fire.</p>	
<p>Check to see if parts and wires are mounted and connected properly, and if connections at the soldered or crimped terminals are secure. Improper installation and connections may cause excessive heat generation, fire or an electrical shock.</p>	
<p>If the installation platform or frame has corroded, replace it. A corroded installation platform or frame may cause the unit to fall, resulting in injury.</p>	
<p>Check the earth / grounding, and repair it if the equipment is not properly earthed / grounded. Improper earth / grounding may cause an electrical shock.</p>	

 Caution	
Be sure to measure insulation resistance after the repair, and make sure that the resistance is 1 MΩ or higher. Faulty insulation may cause an electrical shock.	
Be sure to check the drainage of the indoor unit after the repair. Faulty drainage may cause water to enter the room and wet the furniture and floor.	
Do not tilt the unit when removing it. The water inside the unit may spill and wet the furniture and floor.	

2. Icons Used

The following icons are used to attract the attention of the reader to specific information.

Icon	Type of Information	Description
 Warning	Warning	Warning is used when there is danger of personal injury.
 Caution	Caution	Caution is used when there is danger that the reader, through incorrect manipulation, may damage equipment, lose data, get an unexpected result or have to restart (part of) a procedure.
 Note	Note	Note provides information that is not indispensable, but may nevertheless be valuable to the reader, such as tips and tricks.
 Reference	Reference	Reference guides the reader to other places in this binder or in this manual, where he/she will find additional information on a specific topic.

3. Revision History

Month/Year	Version	Revised contents
02 / 2016	SiUS091601E	First edition
10 / 2019	SiUS091601EA	Model addition : FTX18/24UVJU, FDMQ12/18/24RVJU, RXL12QMVJU9, RXL18/24UMVJU

Part 1

General Information

1. Applicable Models	10
2. Functions.....	11

1. Applicable Models

Indoor Unit

FTX09NMVJU
FTX12NMVJU
FTX15NMVJU

FVXS09NVJU
FVXS12NVJU
FVXS15NVJU

FDMQ12RVJU
FDMQ18RVJU
FDMQ24RVJU

FTX18UVJU
FTX24UVJU

Outdoor Unit

RXL09QMVJU
RXL12QMVJU
RXL12QMVJU9
RXL15QMVJU

RXL18UMVJU
RXL24UMVJU

2. Functions

Category	Functions	FTX				FVXS	FDMQ	
		09	12	15	18/24		Wired R/C	Wireless R/C
Basic Function	Inverter (with inverter power control)	●	●	●	●	●	●	●
	Operation limit	Refer to page 236						
	PAM control	●	●	●	●	●	●	●
	Standby electricity saving	●	●★1	●	—	—	—	—
Compressor	Swing compressor	●	●	●	●	●	●	●
	Reluctance DC motor	●	●	●	●	●	●	●
Comfortable Airflow	Power-airflow flap (horizontal blade)	●	●	—	—	●	—	—
	Power-airflow dual flaps (horizontal blades)	—	—	●	●	—	—	—
	Wide-angle louvers (vertical blades)	●	●	●	●	●	—	—
	Auto-swing (up and down)	●	●	●	●	●	—	—
	Auto-swing (right and left)	—	—	—	●	—	—	—
	3-D airflow	—	—	—	●	—	—	—
	COMFORT AIRFLOW operation	●	●	●	●	—	—	—
Comfort Control	Auto fan speed	●	●	●	●	●	●	—
	Switchable fan speed	5 steps	5 steps	5 steps	5 steps	5 steps	3 steps	3 steps
	Indoor unit quiet operation	●	●	●	●	●	—	—
	OUTDOOR UNIT QUIET operation (manual)	—	—	—	●	●	—	—
	INTELLIGENT EYE operation (auto energy saving)	—	—	—	●	—	—	—
	2 selectable temperature sensors	—	—	—	—	—	●	—
	Quick warming function	●	●	●	●	—	●	●
	Hot-start function	●	●	●	●	●	●	●
	Automatic defrosting	●	●	●	●	●	●	●
Operation	Automatic cooling/heating changeover	●	●	●	●	●	●	●
	Program dry operation	●	●	●	●	●	●	●
	Fan only	●	●	●	●	●	●	●
Lifestyle Convenience	Inverter POWERFUL operation	●	●	●	●	●	—	—
	ECONO operation	●	●	●	●	●	—	—
	Indoor unit ON/OFF switch	●	●	●	●	●	—	—
	Emergency operation switch	—	—	—	—	—	—	●
	Signal receiving sign	●	●	●	●	●	—	●★2
Health and Cleanliness	Titanium apatite deodorizing filter	●	●	●	●	●	—	—
	Air filter (prefilter)	●	●	●	●	●	—	—
	Wipe-clean flat panel	●	●	●	●	●	—	—
	Silver ion anti-bacterial drain pan	—	—	—	—	—	●	●
	Filter cleaning indicator	—	—	—	—	—	●	●
Remote Control & Timer	WEEKLY TIMER operation	—	—	—	●	●	—	—
	Schedule timer	—	—	—	—	—	●	—
	24-hour ON/OFF TIMER	—	—	—	●	●	●	—
	72-hour ON/OFF TIMER	—	—	—	—	—	—	●
	Count up-down ON/OFF timer	●	●	●	—	—	—	●
	Off timer (turns unit off after set time)	—	—	—	—	—	●	—
	Setpoint auto reset	—	—	—	—	—	●	—
	Setpoint range set	—	—	—	—	—	●	—
	NIGHT SET mode	●	●	●	●	●	—	—
	Remote controller with back light	●	●	●	●	●	●	—
	DIII-NET compatible (adaptor)	Option	Option	Option	Option	Option	Option	Option
	Wireless LAN connection	Option	Option	Option	Option	Option	—	—

Category	Functions	FTX				FVXS	FDMQ	
		09	12	15	18/24		Wired R/C	Wireless R/C
Worry Free (Reliability & Durability)	Auto-restart (after power failure)	●	●	●	●	●	●	●
	Self-diagnosis (R/C, LED)	●	●	●	●	●	●	●
	Anti-corrosion treatment of outdoor heat exchanger	●	●	●	●	●	●	●
Work & Servicing	Multi-split/split type compatible indoor unit	—	—	—	—	●	●	●
	Chargeless	32.8 ft. (10m)	32.8 ft. (10m)	32.8 ft. (10m)	32.8 ft. (10m)	32.8 ft. (10m)	32.8 ft. (10m)	32.8 ft. (10m)
	Drain pump	—	—	—	—	—	●	●
	Either side drain (right or left)	●	●	●	●	—	—	—
	Low temperature cooling operation	-4°F ★3 (-20°C)	-4°F ★3 (-20°C)	-4°F ★3 (-20°C)	-4°F ★3 (-20°C)	-4°F ★3 (-20°C)	-4°F ★3 (-20°C)	-4°F ★3 (-20°C)
	°F/°C changeover R/C temperature display (factory setting: °F)	●	●	●	●	●	●	— (°F only)

● : Available

— : Not available

★1 : Not available with RXL12QMVJU9

★2 : Receiving sound only

★3 : Below 50°F (10°C): Needs setting on outdoor unit.

09/12/15 class cutting jumper on the main PCB

18/24 class switch on the service monitor PCB

Below 14°F (-10°C): Need to install the air direction adjustment grille.

Part 2 Specifications

1. Specifications 14

1. Specifications

Model	Indoor Unit		FTX09NMVJU		FTX12NMVJU	
	Outdoor Unit		RXL09QMVJU		RXL12QMVJU	
			Cooling	Heating	Cooling	Heating
Power Supply			1 ϕ , 60 Hz, 208 - 230 V		1 ϕ , 60 Hz, 208 - 230 V	
Capacity Rated (Min. ~ Max.)	kW		2.64 (1.30 ~ 3.20)	3.20 (1.30 ~ 4.70)	3.20 (1.30 ~ 3.90)	4.00 (1.30 ~ 5.50)
	Btu/h		9,000 (4,400 ~ 10,900)	10,900 (4,400 ~ 16,000)	10,900 (4,400 ~ 13,300)	13,600 (4,400 ~ 18,800)
	kcal/h		2,270 (1,120 ~ 2,750)	2,750 (1,120 ~ 4,040)	2,750 (1,120 ~ 3,350)	3,440 (1,120 ~ 4,730)
Moisture Removal	gal/h		0.32	—	0.45	—
Running Current (Rated)	A		3.76 - 3.40	3.95 - 3.57	4.36 - 3.94	5.10 - 4.61
Power Consumption Rated (Min. ~ Max.)	W		720 (250 ~ 1,180)	760 (230 ~ 1,440)	870 (280 ~ 1,390)	1,025 (240 ~ 1,660)
Power Factor (Rated)	%		92.1 - 92.1	92.6 - 92.6	96.0 - 96.0	96.7 - 96.7
COP Rated (Min. ~ Max.)	W/W		3.66 (5.20 ~ 2.70)	4.20 (5.64 ~ 3.26)	3.68 (4.64 ~ 2.80)	3.90 (5.42 ~ 3.30)
EER Rated (Min. ~ Max.)	Btu/h-W		12.5 (17.6 ~ 9.2)	14.3 (19.1 ~ 11.1)	12.5 (15.7 ~ 9.6)	13.3 (18.3 ~ 11.3)
SEER / HSPF			20.0	12.5	20.0	12.0
Piping Connections	Liquid	in. (mm)	ϕ 1/4 (ϕ 6.4)		ϕ 1/4 (ϕ 6.4)	
	Gas	in. (mm)	ϕ 3/8 (ϕ 9.5)		ϕ 3/8 (ϕ 9.5)	
	Drain	in. (mm)	ϕ 5/8 (ϕ 16.0)		ϕ 5/8 (ϕ 16.0)	
Heat Insulation			Both Liquid and Gas Pipes		Both Liquid and Gas Pipes	
Max. Interunit Piping Length	ft (m)		65-5/8 (20)		65-5/8 (20)	
Max. Interunit Height Difference	ft (m)		49-1/4 (15)		49-1/4 (15)	
Chargeless	ft (m)		32-13/16 (10)		32-13/16 (10)	
Amount of Additional Charge of Refrigerant	oz/ft (g/m)		0.21 (20)		0.21 (20)	
Indoor Unit			FTX09NMVJU		FTX12NMVJU	
Front Panel Color			White		White	
Airflow Rate	H	cfm (m ³ /min)	417 (11.8)	403 (11.4)	434 (12.3)	413 (11.7)
	M		297 (8.4)	328 (9.3)	311 (8.8)	321 (9.1)
	L		244 (6.9)	251 (7.1)	247 (7.0)	258 (7.3)
	SL		141 (4.0)	215 (6.1)	145 (4.1)	219 (6.2)
Fan	Type / Motor Output	W	Cross Flow Fan / 21		Cross Flow Fan / 28	
	Speed	Steps	5 Steps, Quiet, Auto		5 Steps, Quiet, Auto	
Air Direction Control			Right, Left, Horizontal, Downward		Right, Left, Horizontal, Downward	
Air Filter			Removable, Washable, Mildew Proof		Removable, Washable, Mildew Proof	
Running Current (Rated)	A		0.25 - 0.23	0.23 - 0.21	0.28 - 0.25	0.25 - 0.23
Power Consumption (Rated)	W		28 - 28	25 - 25	31 - 31	28 - 28
Power Factor (Rated)	%		53.8 - 52.9	52.3 - 51.8	53.2 - 53.9	53.8 - 52.9
Temperature Control			Microcomputer Control		Microcomputer Control	
Dimensions (H x W x D)	in. (mm)		11-1/4 x 30-5/16 x 8-3/4 (285 x 770 x 223)		11-1/4 x 30-5/16 x 8-3/4 (285 x 770 x 223)	
Packaged Dimensions (H x W x D)	in. (mm)		14-3/16 x 32-11/16 x 12 (360 x 831 x 305)		14-3/16 x 32-11/16 x 12 (360 x 831 x 305)	
Weight (Mass)	Lbs (kg)		18 (8)		18 (8)	
Gross Weight (Gross Mass)	Lbs (kg)		24 (11)		25 (12)	
Sound Pressure Level	H / M / L / SL	dB(A)	43 / 36 / 30 / 19	43 / 36 / 29 / 25	45 / 37 / 30 / 19	45 / 37 / 30 / 26
Outdoor Unit			RXL09QMVJU		RXL12QMVJU	
Casing Color			Ivory White		Ivory White	
Heat Exchanger	Fin / Spec. Tube		Waffle Fin (PE) / ϕ 7 mm Hi-XD Tube		Waffle Fin (PE) / ϕ 7 mm Hi-XD Tube	
Compressor	Type		Hermetically Sealed Swing Type		Hermetically Sealed Swing Type	
	Model		1YC23AUXD		2YC36PXD	
	Motor Output	W	790		1,100	
Refrigerant Oil	Type / Charge	oz (L)	FVC50K / 12.4 (0.375)		FVC50K / 21.5 (0.650)	
Refrigerant	Type / Charge	Lbs (kg)	R-410A / 2.09 (0.95)		R-410A / 2.09 (0.95)	
Airflow Rate	H	cfm (m ³ /min)	1,105 (31.3)	922 (26.1)	1,144 (32.4)	1,006 (28.5)
	SL		865 (24.5)	777 (22.0)	865 (24.5)	777 (22.0)
Fan	Type / Motor Output	W	Propeller / 18		Propeller / 20	
Running Current (Rated)	A		3.51 - 3.17	3.72 - 3.36	4.08 - 3.69	4.85 - 4.38
Power Consumption (Rated)	W		692 - 692	735 - 735	839 - 839	997 - 997
Power Factor (Rated)	%		94.8 - 94.9	95.1 - 95.1	98.9 - 98.9	98.9 - 99.0
Starting Current	A		3.95		4.94	
Dimensions (H x W x D)	in. (mm)		21-5/8 x 26-9/16 x 11-3/16 (550 x 675 x 284)		21-5/8 x 26-9/16 x 11-3/16 (550 x 675 x 284)	
Packaged Dimensions (H x W x D)	in. (mm)		24-3/4 x 32-11/16 x 16 (629 x 830 x 407)		24-3/4 x 32-11/16 x 16 (629 x 830 x 407)	
Weight (Mass)	Lbs (kg)		60 (27)		70 (32)	
Gross Weight (Gross Mass)	Lbs (kg)		71 (32)		80 (36)	
Sound Pressure Level	H	dB(A)	49	49	50	50
Conditions Based on			Indoor ; 80°FDB (26.7°CDB) / 67°FWB (19.4°CWB) Outdoor ; 95°FDB (35°CDB) / 75°FWB (24°CWB) Piping Length: 25 ft (7.5 m)	Indoor ; 70°FDB (21°CDB) / 60°FWB (15.6°CWB) Outdoor ; 47°FDB (8.3°CDB) / 43°FWB (6°CWB) Piping Length: 25 ft (7.5 m)	Indoor ; 80°FDB (26.7°CDB) / 67°FWB (19.4°CWB) Outdoor ; 95°FDB (35°CDB) / 75°FWB (24°CWB) Piping Length: 25 ft (7.5 m)	Indoor ; 70°FDB (21°CDB) / 60°FWB (15.6°CWB) Outdoor ; 47°FDB (8.3°CDB) / 43°FWB (6°CWB) Piping Length: 25 ft (7.5 m)
Drawing No.			C: 3D101720		C: 3D101721	
Notes			SL: The quiet fan level of the airflow rate setting.		SL: The quiet fan level of the airflow rate setting.	

Conversion Formulae

$$\begin{aligned} \text{kcal/h} &= \text{kW} \times 860 \\ \text{Btu/h} &= \text{kW} \times 3412 \\ \text{cfm} &= \text{m}^3/\text{min} \times 35.3 \end{aligned}$$

Model	Indoor Unit		FTX12NMVJU		FTX15NMVJU	
	Outdoor Unit		RXL12QMVCJU9		RXL15QMVCJU	
			Cooling	Heating	Cooling	Heating
Power Supply			1 ϕ, 60 Hz, 208 - 230 V		1 ϕ, 60 Hz, 208 - 230 V	
Capacity Rated (Min. ~ Max.)			kW		4.40 (1.70 ~ 5.40)	
			Btu/h		15,000 (5,800 ~ 18,400)	
			kcal/h		3,780 (1,460 ~ 4,640)	
Moisture Removal			gal/h		0.63	
Running Current (Rated)			A		5.92 - 5.35	
Power Consumption Rated (Min. ~ Max.)			W		1,150 (290 ~ 1,630)	
Power Factor (Rated)			%		93.5 - 93.5	
COP Rated (Min. ~ Max.)			W/W		3.82 (5.86 ~ 3.30)	
EER Rated (Min. ~ Max.)			Btu/h-W		13 (20 ~ 11.3)	
SEER / HSPF			20.0		12.0	
Piping Connections			Liquid		ϕ 1/4 (ϕ 6.4)	
			Gas		ϕ 3/8 (ϕ 9.5)	
			Drain		ϕ 5/8 (ϕ 16.0)	
Heat Insulation			Both Liquid and Gas Pipes		Both Liquid and Gas Pipes	
Max. Interunit Piping Length			ft (m)		98-1/2 (30)	
Max. Interunit Height Difference			ft (m)		65-5/8 (20)	
Chargeless			ft (m)		32-13/16 (10)	
Amount of Additional Charge of Refrigerant			oz/ft (g/m)		0.21 (20)	
Indoor Unit			FTX12NMVJU		FTX15NMVJU	
Front Panel Color			White		White	
Airflow Rate			H		434 (12.3)	
			M		311 (8.8)	
			L		247 (7.0)	
			SL		145 (4.1)	
Fan			Type / Motor Output		Cross Flow Fan / 28	
			Speed		Steps	
Air Direction Control			Right, Left, Horizontal, Downward		Right, Left, Horizontal, Downward	
Air Filter			Removable, Washable, Mildew Proof		Removable, Washable, Mildew Proof	
Running Current (Rated)			A		0.23 - 0.21	
Power Consumption (Rated)			W		33 - 33	
Power Factor (Rated)			%		69.0 - 68.3	
Temperature Control			Microcomputer Control		Microcomputer Control	
Dimensions (H x W x D)			in. (mm)		11-5/8 x 39 x 10-3/8 (295 x 990 x 263)	
Packaged Dimensions (H x W x D)			in. (mm)		14-3/16 x 32-11/16 x 12 (360 x 831 x 305)	
Weight (Mass)			Lbs (kg)		18 (8)	
Gross Weight (Gross Mass)			Lbs (kg)		25 (12)	
Sound Pressure Level			H / M / L / SL		dB(A)	
Outdoor Unit			RXL12QMVCJU9		RXL15QMVCJU	
Casing Color			Ivory White		Ivory White	
Heat Exchanger			Fin / Spec. Tube		Waffle Fin (PE) / ϕ 7 mm Hi-XD Tube	
Compressor			Type		Hermetically Sealed Swing Type	
			Model		2YC36PXD	
			Motor Output		W	
Refrigerant Oil			Type / Charge		oz (L)	
Refrigerant			Type / Charge		Lbs (kg)	
Airflow Rate			H		1,144 (32.4)	
			SL		865 (24.5)	
Fan			Type / Motor Output		W	
Running Current (Rated)			A		4.08 - 3.69	
Power Consumption (Rated)			W		839 - 839	
Power Factor (Rated)			%		98.9 - 98.9	
Starting Current			A		4.94	
Dimensions (H x W x D)			in. (mm)		21-5/8 x 26-9/16 x 11-3/16 (550 x 675 x 284)	
Packaged Dimensions (H x W x D)			in. (mm)		24-3/4 x 32-11/16 x 16 (629 x 830 x 407)	
Weight (Mass)			Lbs (kg)		70 (32)	
Gross Weight (Gross Mass)			Lbs (kg)		80 (36)	
Sound Pressure Level			H		dB(A)	
Conditions Based on			Indoor ; 80°FDB (26.7°CDB) / 67°FWB (19.4°CWB) Outdoor ; 95°FDB (35°CDB) / 75°FWB (24°CWB) Piping Length: 25 ft (7.5 m)		Indoor ; 70°FDB (21°CDB) / 60°FWB (15.6°CWB) Outdoor ; 47°FDB (8.3°CDB) / 43°FWB (6°CWB) Piping Length: 25 ft (7.5 m)	
Drawing No.			C: 3D123801		C: 3D101716	
Notes			SL: The quiet fan level of the airflow rate setting.		SL: The quiet fan level of the airflow rate setting.	

Conversion Formulae
kcal/h = kW × 860
Btu/h = kW × 3412
cfm = m³/min × 35.3

Model	Indoor Unit		FTX18UVJU		FTX24UVJU	
	Outdoor Unit		RXL18UMVJU		RXL24UMVJU	
			Cooling	Heating	Cooling	Heating
Power Supply			1 ϕ , 60 Hz, 208 - 230 V		1 ϕ , 60 Hz, 208 - 230 V	
Capacity Rated (Min. ~ Max.)	Btu/h		18,000 (9,000 ~ 21,600)	21,600 (9,000 ~ 28,000)	21,200 (9,000 ~ 25,800)	24,000 (9,000 ~ 32,000)
Power Consumption Rated (Min. ~ Max.)	W		1,440 (570 ~ 1,930)	1,809 (540 ~ 3,080)	1,696 (580 ~ 2,360)	2,132 (570 ~ 3,800)
Power Factor (Rated)	%		96	97	96	97
COP (Min. ~ Max.)	W/W		—	3.50 (4.88 ~ 2.66)	—	3.30 (4.62 ~ 2.46)
EER (Min. ~ Max.)	Btu/h-W		12.50 (15.80 ~ 11.20)	—	12.50 (15.50 ~ 10.90)	—
SEER / HSPF			20.30	10.30	20.00	10.30
Piping Connections	Liquid	in. (mm)	ϕ 1/4 (ϕ 6.4)		ϕ 1/4 (ϕ 6.4)	
	Gas	in. (mm)	ϕ 1/2 (ϕ 12.7)		ϕ 5/8 (ϕ 15.9)	
	Drain	in. (mm)	ϕ 5/8 (ϕ 16)		ϕ 5/8 (ϕ 16)	
Max. Interunit Piping Length	ft (m)		98-1/2 (30)		98-1/2 (30)	
Max. Interunit Height Difference	ft (m)		65-5/8 (20)		65-5/8 (20)	
Chargeless	ft (m)		32-13/16 (10)		32-13/16 (10)	
Amount of Additional Charge of Refrigerant	oz/ft (g/m)		0.32 (30)		0.32 (30)	
Indoor Unit			FTX18UVJU		FTX24UVJU	
Front Panel Color (Munsell No.)			White (N-95)		White (N-95)	
Airflow Rate	H	cfm (m ³ /min)	583 (16.5)	713 (20.2)	643 (18.2)	699 (19.8)
	M		484 (13.7)	583 (16.5)	494 (14.0)	572 (16.2)
	L		385 (10.9)	431 (12.2)	350 (9.9)	445 (12.6)
	SL		360 (10.2)	399 (11.3)	328 (9.3)	403 (11.4)
Fan	Type		Cross Flow Fan		Cross Flow Fan	
	Speed	Steps	5 Steps, Quiet, Auto		5 Steps, Quiet, Auto	
Dimensions (H x W x D)	in. (mm)		13-3/8 x 41-5/16 x 10-1/4 (340 x 1,050 x 261)		13-3/8 x 41-5/16 x 10-1/4 (340 x 1,050 x 261)	
Packaged Dimensions (H x W x D)	in. (mm)		13-1/2 x 45-1/2 x 17 (342 x 1,160 x 429)		13-1/2 x 45-1/2 x 17 (342 x 1,160 x 429)	
Weight (Mass)	Lbs (kg)		33 (15)		33 (15)	
Gross Weight (Gross Mass)	Lbs (kg)		42 (19)		44 (20)	
Sound Pressure Level	H / M / L / SL	dB(A)	46 / 41 / 36 / 33	48 / 42 / 35 / 32	51 / 44 / 37 / 34	48 / 42 / 37 / 34
Outdoor Unit			RXL18UMVJU		RXL24UMVJU	
Casing Color			Ivory White		Ivory White	
Heat Exchanger		Fin / Spec. Tube	Waffle Fin (PE) / ϕ 7 mm Hi-XD Tube		Waffle Fin (PE) / ϕ 7 mm Hi-XD Tube	
Compressor	Type		Hermetically Sealed Swing Type		Hermetically Sealed Swing Type	
	Model		2YC63AAXD		2YC63AAXD	
Refrigerant Oil	Type / Charge	oz (L)	FVC50K / 31.75 (0.900)		FVC50K / 31.75 (0.900)	
Refrigerant	Type / Charge	Lbs (kg)	R-410A / 3.53 (1.60)		R-410A / 3.53 (1.60)	
Airflow Rate	H	cfm	2,417 (68.5)	2,361 (66.9)	2,417 (68.5)	2,361 (66.9)
	SL	(m ³ /min)	1,907 (54.0)	2,134 (60.4)	1,907 (54.0)	2,134 (60.4)
Fan	Type		Propeller		Propeller	
Dimensions (H x W x D)	in. (mm)		28-15/16 x 34-1/4 x 12-5/8 (735 x 870 x 320)		28-15/16 x 34-1/4 x 12-5/8 (735 x 870 x 320)	
Packaged Dimensions (H x W x D)	in. (mm)		31-7/8 x 41-1/2 x 18-1/4 (810 x 1,056 x 464)		31-7/8 x 41-1/2 x 18-1/4 (810 x 1,056 x 464)	
Weight (Mass)	Lbs (kg)		130 (59)		130 (59)	
Gross Weight (Gross Mass)	Lbs (kg)		137 (62)		137 (62)	
Sound Pressure Level		dB(A)	54 / —	55 / —	55 / —	55 / —
Conditions Based on			Indoor ; 80.0°FDB (26.7°CDB) / 67.0°FWB (19.4°CWB) Outdoor ; 95.0°FDB (35°CDB) / 75°FWB (23.9°CWB) Piping Length: 25 ft (7.5 m)	Indoor ; 70.0°FDB (21.1°CDB) / 60.0°FWB (15.6°CWB) Outdoor ; 47°FDB (8.33°CDB) / 43.0°FWB (6.11°CWB) Piping Length: 25 ft (7.5 m)	Indoor ; 80.0°FDB (26.7°CDB) / 67.0°FWB (19.4°CWB) Outdoor ; 95.0°FDB (35°CDB) / 75°FWB (23.9°CWB) Piping Length: 25 ft (7.5 m)	Indoor ; 70.0°FDB (21.1°CDB) / 60.0°FWB (15.6°CWB) Outdoor ; 47°FDB (8.33°CDB) / 43.0°FWB (6.11°CWB) Piping Length: 25 ft (7.5 m)
Drawing No.			C: 3D123803A		C: 3D123803A	
Note			SL: The quiet fan level of the airflow rate setting.		SL: The quiet fan level of the airflow rate setting.	

Conversion Formulae
kcal/h = kW x 860
Btu/h = kW x 3412
cfm = m ³ /min x 35.3

Model	Indoor Unit		FVXS09NVJU		FVXS12NVJU	
	Outdoor Unit		RXL09QMVJU		RXL12QMVJU	
			Cooling	Heating	Cooling	Heating
Power Supply			1 ϕ, 60 Hz, 208 - 230 V		1 ϕ, 60 Hz, 208 - 230 V	
Capacity Rated (Min. ~ Max.)	kW		2.64 (1.30 ~ 3.00)	2.95 (1.30 ~ 4.20)	3.00 (1.30 ~ 3.60)	3.80 (1.30 ~ 5.00)
	Btu/h		9,000 (4,400 ~ 10,200)	10,100 (4,400 ~ 14,300)	10,200 (4,400 ~ 12,300)	13,000 (4,400 ~ 17,100)
	kcal/h		2,270 (1,120 ~ 2,580)	2,540 (1,120 ~ 3,610)	2,580 (1,120 ~ 3,100)	3,270 (1,120 ~ 4,300)
Moisture Removal	gal/h		0.32	—	0.45	—
Running Current (Rated)	A		3.75 - 3.39	3.67 - 3.32	4.20 - 3.80	4.69 - 4.24
Power Consumption Rated (Min. ~ Max.)	W		720 (250 ~ 820)	720 (240 ~ 1,390)	850 (270 ~ 1,350)	950 (250 ~ 1,570)
Power Factor (Rated)	%		92.3 - 92.3	94.3 - 94.3	97.3 - 97.3	97.4 - 97.4
COP Rated (Min. ~ Max.)	W/W		3.66 (5.20 ~ 3.66)	4.10 (5.42 ~ 3.02)	3.52 (4.80 ~ 2.66)	4.00 (5.20 ~ 3.18)
EER Rated (Min. ~ Max.)	Btu/h-W		12.5 (17.6 ~ 12.4)	14 (18.3 ~ 10.3)	12.0 (16.3 ~ 9.1)	13.7 (17.6 ~ 10.9)
SEER / HSPF			20.0	11.7	20.0	11.4
Piping Connections	Liquid	in. (mm)	ϕ 1/4 (ϕ 6.4)		ϕ 1/4 (ϕ 6.4)	
	Gas	in. (mm)	ϕ 3/8 (ϕ 9.5)		ϕ 3/8 (ϕ 9.5)	
	Drain	in. (mm)	ϕ 13/16 (ϕ 20.0)		ϕ 13/16 (ϕ 20.0)	
Heat Insulation			Both Liquid and Gas Pipes		Both Liquid and Gas Pipes	
Max. Interunit Piping Length	ft (m)		65-5/8 (20)		65-5/8 (20)	
Max. Interunit Height Difference	ft (m)		49-1/4 (15)		49-1/4 (15)	
Chargeless	ft (m)		32-13/16 (10)		32-13/16 (10)	
Amount of Additional Charge of Refrigerant	oz/ft (g/m)		0.21 (20)		0.21 (20)	
Indoor Unit			FVXS09NVJU		FVXS12NVJU	
Front Panel Color			White		White	
Airflow Rate	H	cfm (m³/min)	290 (8.2)	311 (8.8)	300 (8.5)	332 (9.4)
	M		230 (6.5)	244 (6.9)	237 (6.7)	258 (7.3)
	L		169 (4.8)	177 (5.0)	173 (4.9)	184 (5.2)
	SL		145 (4.1)	155 (4.4)	159 (4.5)	166 (4.7)
Fan	Type / Motor Output	W	Turbo Fan / 12.3		Turbo Fan / 13.4	
	Speed	Steps	5 Steps, Quiet, Auto		5 Steps, Quiet, Auto	
Air Direction Control			Right, Left, Horizontal, Downward		Right, Left, Horizontal, Downward	
Air Filter			Removable, Washable, Mildew Proof		Removable, Washable, Mildew Proof	
Running Current (Rated)	A		0.14 - 0.13	0.15 - 0.14	0.14 - 0.13	0.15 - 0.14
Power Consumption (Rated)	W		15 - 15	17 - 17	15 - 15	17 - 17
Power Factor (Rated)	%		51.5 - 50.2	54.5 - 52.8	51.5 - 50.2	54.5 - 52.8
Temperature Control			Microcomputer Control		Microcomputer Control	
Dimensions (H × W × D)	in. (mm)		23-5/8 × 27-9/16 × 8-1/4 (600 × 700 × 210)		23-5/8 × 27-9/16 × 8-1/4 (600 × 700 × 210)	
Packaged Dimensions (H × W × D)	in. (mm)		27-3/8 × 30-15/16 × 11 (696 × 786 × 280)		27-3/8 × 30-15/16 × 11 (696 × 786 × 280)	
Weight (Mass)	Lbs (kg)		31 (14)		31 (14)	
Gross Weight (Gross Mass)	Lbs (kg)		40 (18)		40 (18)	
Sound Pressure Level	H / M / L / SL	dB(A)	38 / 32 / 26 / 23	38 / 32 / 26 / 23	39 / 33 / 27 / 24	39 / 33 / 27 / 24
Outdoor Unit			RXL09QMVJU		RXL12QMVJU	
Casing Color			Ivory White		Ivory White	
Heat Exchanger	Fin / Spec. Tube		Waffle Fin (PE) / ϕ 7 mm Hi-XD Tube		Waffle Fin (PE) / ϕ 7 mm Hi-XD Tube	
Compressor	Type		Hermetically Sealed Swing Type		Hermetically Sealed Swing Type	
	Model		1YC23AUXD		2YC36PXD	
	Motor Output	W	790		1,100	
Refrigerant Oil	Type / Charge	oz (L)	FVC50K / 12.4 (0.375)		FVC50K / 21.5 (0.650)	
Refrigerant	Type / Charge	Lbs (kg)	R-410A / 2.09 (0.95)		R-410A / 2.09 (0.95)	
Airflow Rate	H	cfm (m³/min)	1,105 (31.3)	922 (26.1)	1,144 (32.4)	1,006 (28.5)
	SL		865 (24.5)	777 (22.0)	865 (24.5)	777 (22.0)
Fan	Type / Motor Output	W	Propeller / 18		Propeller / 20	
Running Current (Rated)	A		3.61 - 3.26	3.52 - 3.18	4.06 - 3.67	4.54 - 4.10
Power Consumption (Rated)	W		705 - 705	703 - 703	835 - 835	933 - 933
Power Factor (Rated)	%		93.9 - 94.0	96.0 - 96.1	98.8 - 98.9	98.8 - 98.9
Starting Current	A		3.76		4.54	
Dimensions (H × W × D)	in. (mm)		21-5/8 × 26-9/16 × 11-3/16 (550 × 675 × 284)		21-5/8 × 26-9/16 × 11-3/16 (550 × 675 × 284)	
Packaged Dimensions (H × W × D)	in. (mm)		24-3/4 × 32-11/16 × 16 (629 × 830 × 407)		24-3/4 × 32-11/16 × 16 (629 × 830 × 407)	
Weight (Mass)	Lbs (kg)		60 (27)		70 (32)	
Gross Weight (Gross Mass)	Lbs (kg)		71 (32)		80 (36)	
Sound Pressure Level	H	dB(A)	49	49	50	50
Conditions Based on			Indoor ; 80°FDB (26.7°CDB) / 67°FWB (19.4°CWB) Outdoor ; 95°FDB (35°CDB) / 75°FWB (24°CWB) Piping Length: 25 ft (7.5 m)	Indoor ; 70°FDB (21°CDB) / 60°FWB (15.6°CWB) Outdoor ; 47°FDB (8.3°CDB) / 43°FWB (6°CWB) Piping Length: 25 ft (7.5 m)	Indoor ; 80°FDB (26.7°CDB) / 67°FWB (19.4°CWB) Outdoor ; 95°FDB (35°CDB) / 75°FWB (24°CWB) Piping Length: 25 ft (7.5 m)	Indoor ; 70°FDB (21°CDB) / 60°FWB (15.6°CWB) Outdoor ; 47°FDB (8.3°CDB) / 43°FWB (6°CWB) Piping Length: 25 ft (7.5 m)
Drawing No.			C: 3D101722		C: 3D101724	
Notes			SL: The quiet fan level of the airflow rate setting.		SL: The quiet fan level of the airflow rate setting.	

Conversion Formulae
kcal/h = kW × 860
Btu/h = kW × 3412
cfm = m³/min × 35.3

Model	Indoor Unit		FVXS12NVJU		FVXS15NVJU	
	Outdoor Unit		RXL12QMVJU9		RXL15QMVJU	
			Cooling	Heating	Cooling	Heating
Power Supply			1 ϕ, 60 Hz, 208 - 230 V		1 ϕ, 60 Hz, 208 - 230 V	
Capacity Rated (Min. ~ Max.)			kW		3.80 (1.30 ~ 3.60)	
			Btu/h		10,200 (4,400 ~ 12,300)	
			kcal/h		3,270 (1,120 ~ 4,300)	
Moisture Removal			gal/h		0.45	
Running Current (Rated)			A		4.20 - 3.80	
Power Consumption Rated (Min. ~ Max.)			W		850 (270 ~ 1,350)	
Power Factor (Rated)			%		97.3 - 97.3	
COP Rated (Min. ~ Max.)			W/W		3.52 (4.80 ~ 2.66)	
EER Rated (Min. ~ Max.)			Btu/h-W		12.0 (16.3 ~ 9.1)	
SEER / HSPF					20.0	
Piping Connections			Liquid		in. (mm)	
			Gas		in. (mm)	
			Drain		in. (mm)	
Heat Insulation			Both Liquid and Gas Pipes		Both Liquid and Gas Pipes	
Max. Interunit Piping Length			ft (m)		65-5/8 (20)	
Max. Interunit Height Difference			ft (m)		49-1/4 (15)	
Chargeless			ft (m)		32-13/16 (10)	
Amount of Additional Charge of Refrigerant			oz/ft (g/m)		0.21 (20)	
Indoor Unit			FVXS12NVJU		FVXS15NVJU	
Front Panel Color			White		White	
Airflow Rate			H		300 (8.5)	
			M		237 (6.7)	
			L		173 (4.9)	
			SL		159 (4.5)	
Fan			Type / Motor Output		W	
			Speed		Steps	
Air Direction Control			Right, Left, Horizontal, Downward		Right, Left, Horizontal, Downward	
Air Filter			Removable, Washable, Mildew Proof		Removable, Washable, Mildew Proof	
Running Current (Rated)			A		0.14 - 0.13	
Power Consumption (Rated)			W		15 - 15	
Power Factor (Rated)			%		51.5 - 50.2	
Temperature Control			Microcomputer Control		Microcomputer Control	
Dimensions (H x W x D)			in. (mm)		23-5/8 x 27-9/16 x 8-1/4 (600 x 700 x 210)	
Packaged Dimensions (H x W x D)			in. (mm)		27-3/8 x 30-15/16 x 11 (696 x 786 x 280)	
Weight (Mass)			Lbs (kg)		31 (14)	
Gross Weight (Gross Mass)			Lbs (kg)		40 (18)	
Sound Pressure Level			H / M / L / SL		dB(A)	
Outdoor Unit			RXL12QMVJU9		RXL15QMVJU	
Casing Color			Ivory White		Ivory White	
Heat Exchanger			Fin / Spec. Tube		Waffle Fin (PE) / ϕ 7 mm Hi-XD Tube	
Compressor			Type		Hermetically Sealed Swing Type	
			Model		2YC36PXD	
			Motor Output		W	
Refrigerant Oil			Type / Charge		oz (L)	
Refrigerant			Type / Charge		Lbs (kg)	
Airflow Rate			H		1,144 (32.4)	
			SL		865 (24.5)	
Fan			Type / Motor Output		W	
Running Current (Rated)			A		4.06 - 3.67	
Power Consumption (Rated)			W		835 - 835	
Power Factor (Rated)			%		98.8 - 98.9	
Starting Current			A		4.54	
Dimensions (H x W x D)			in. (mm)		21-5/8 x 26-9/16 x 11-3/16 (550 x 675 x 284)	
Packaged Dimensions (H x W x D)			in. (mm)		24-3/4 x 32-11/16 x 16 (629 x 830 x 407)	
Weight (Mass)			Lbs (kg)		70 (32)	
Gross Weight (Gross Mass)			Lbs (kg)		80 (36)	
Sound Pressure Level			H		dB(A)	
Conditions Based on			Indoor : 80°FDB (26.7°CDB) / 67°FWB (19.4°CWB) Outdoor : 95°FDB (35°CDB) / 75°FWB (24°CWB) Piping Length: 25 ft (7.5 m)		Indoor : 70°FDB (21°CDB) / 60°FWB (15.6°CWB) Outdoor : 47°FDB (8.3°CDB) / 43°FWB (6°CWB) Piping Length: 25 ft (7.5 m)	
Drawing No.			C: 3D123806		C: 3D101718	
Notes			SL: The quiet fan level of the airflow rate setting.		SL: The quiet fan level of the airflow rate setting.	

Conversion Formulae
kcal/h = kW x 860
Btu/h = kW x 3412
cfm = m ³ /min x 35.3

Model	Indoor Unit		FDMQ12RVJU				FDMQ18RVJU						
	Outdoor Unit		RXL12QMJVU9				RXL18UMVJU						
			Cooling		Heating		Cooling		Heating				
Power Supply			1 ϕ, 60 Hz, 208 - 230 V				1 ϕ, 60 Hz, 208 - 230 V						
Capacity (Min. ~ Max.) ★4			kW	3.18 (1.91 ~ 3.87) ★1	3.99 (1.85 ~ 4.98) ★2	5.16 (2.64 ~ 5.92) ★1	6.33 (2.64 ~ 7.33) ★2	Btu/h	10,800 (6,500 ~ 13,200) ★1	13,600 (6,300 ~ 17,000) ★2	17,600 (9,000 ~ 20,200) ★1	21,600 (9,000 ~ 25,000) ★2	
			kcal/h	2,720 (1,640 ~ 3,330) ★1	3,430 (1,590 ~ 4,280) ★2	4,440 (2,270 ~ 5,090) ★1	5,440 (2,270 ~ 6,300) ★2						
Capacity ★3, ★4			kW	—	2.52	—	4.28						
			Btu/h	—	8,600	—	14,600						
			kcal/h	—	2,170	—	3,680						
COP (Min. ~ Max.)			—		3.70 (4.62 ~ 2.40)	—		3.80 (5.28 ~ 2.78)					
EER (Min. ~ Max.)			11.7 (14.4 ~ 9.9)		—	12.7 (15.8 ~ 11.7)		—					
SEER / HSPF			18.0		10.8	19.4		10.3					
Indoor Unit			FDMQ12RVJU				FDMQ18RVJU						
Casing Color			—				—						
Dimensions (H × W × D)			in. (mm) 9-5/8 × 27-9/16 × 31-1/2 (245 × 700 × 800)				9-5/8 × 39-3/8 × 31-1/2 (245 × 1,000 × 800)						
Coil	Type		Cross Fin Coil				Cross Fin Coil						
	Rows × Stages × Fin per inch		3 × 26 × 18				3 × 26 × 18						
	Face Area		ft ² (m ²)		1-15/16 (0.178)		3-1/8 (0.288)						
Fan	Type / Motor Output		W Sirocco Fan / 130				Sirocco Fan / 230						
	Airflow Rate	H / M / L	cfm (m ³ /min)	392 / 332 / 275 (11.1 / 9.4 / 7.8)	392 / 332 / 275 (11.1 / 9.4 / 7.8)	675 / 572 / 473 (19.1 / 16.2 / 13.4)	675 / 572 / 473 (19.1 / 16.2 / 13.4)						
	External Static Pressure		inH ₂ O	0.20 (0.60 - 0.12) ★5				0.20 (0.60 - 0.20) ★5					
			Pa	50 (150 - 30) ★5				50 (150 - 50) ★5					
Sound Pressure Level			33		33	35		35					
Sound Power Level			47		47	49		49					
Air Filter			— ★6				— ★6						
Weight (Mass) / Gross Weight (Gross Mass)			Lbs (kg)		64 (29) / 71 (32)		82 (37) / 88 (40)						
Piping Connections	Liquid		in. (mm)		ϕ 1/4 (6.4) (Flare)		ϕ 1/4 (6.4) (Flare)						
	Gas		in. (mm)		ϕ 3/8 (9.5) (Flare)		ϕ 1/2 (12.7) (Flare)						
	Drain		in. (mm)		I.D. ϕ 1 (25) / O.D. ϕ 1-1/4 (32)		I.D. ϕ 1 (25) / O.D. ϕ 1-1/4 (32)						
Remote Controller (Option)	Wired		BRC1E73				BRC1E73						
	Wireless		BRC082A43				BRC082A43						
Outdoor Unit			RXL12QMJVU9				RXL18UMVJU						
Casing Color			Ivory White				Ivory White						
Dimensions (H × W × D)			in. (mm) 21-5/8 × 26-9/16 × 11-3/16 (550 × 675 × 284)				28-15/16 × 34-1/4 × 12-5/8 (735 × 870 × 320)						
Coil	Type		Cross Fin Coil				Cross Fin Coil						
	Rows × Stages × Fin per inch		2 × 24 × 17				2 × 32 × 18						
	Face Area		ft ² (m ²)		3-11/16 (0.342)		7-1/16 (0.658)						
Compressor	Model		2YC36PXD				2YC63AAXD						
	Type		Hermetically Sealed Swing Type				Hermetically Sealed Swing Type						
Motor Output			W		1,100		1,920						
Fan	Type / Motor Output		W Propeller / 20				Propeller / 76						
	Airflow Rate		cfm (m ³ /min)	1,144 (32.4)	1,006 (28.5)	2,418 (68.5)	2,361 (66.9)						
Sound Pressure Level			dB(A)		50		50		54			55	
Sound Power Level			dB(A)		62		62		66			67	
Weight (Mass) / Gross Weight (Gross Mass)			Lbs (kg)		70 (32) / 80 (36)		130 (59) / 137 (62)						
Piping Connections	Liquid		in. (mm)		ϕ 1/4 (6.4) (Flare)		ϕ 1/4 (6.4) (Flare)						
	Gas		in. (mm)		ϕ 3/8 (9.5) (Flare)		ϕ 1/2 (12.7) (Flare)						
	Drain		in. (mm)		I.D. ϕ 5/8 (16)		I.D. ϕ 5/8 (16)						
Safety Devices			Fuse				Fuse						
Max. Interunit Piping Length			ft (m)		65-5/8 (20)		98-1/2 (30)						
Max. Interunit Height Difference			ft (m)		49-1/4 (15)		65-5/8 (20)						
Chargeless			ft (m)		32-13/16 (10)		32-13/16 (10)						
Amount of Additional Charge of Refrigerant			oz/ft (g/m)		0.21 (20)		0.32 (30)						
Refrigerant Oil	Type / Charge		FVC50K / 12.4 (0.375)				FVC50K / 31.75 (0.900)						
Refrigerant	Type / Charge		R-410A / 2.09 (0.95)				R-410A / 3.53 (1.60)						
Drawing No.			C: 3D123805				C: 3D123805						
Notes			<p>★1 Indoor temp.: 80.0°FDB (26.7°CDB), 67.0°FWB (19.4°CWB) / Outdoor temp.: 95.0°FDB (35.0°CDB) / Equivalent piping length: 25 ft (7.6 m) / Level difference: 0</p> <p>★2 Indoor temp.: 70.0°FDB (21.1°CDB) / Outdoor temp.: 47.0°FDB (8.3°CDB), 43.0°FWB (6.1°CWB) / Equivalent piping length: 25 ft (7.6 m) / Level difference: 0</p> <p>★3 Indoor temp.: 70.0°FDB (21.1°CDB) / Outdoor temp.: 17.0°FDB (-8.3°CDB), 15.0°FWB (-9.4°CWB) / Equivalent piping length: 25 ft (7.6 m) / Level difference: 0</p> <p>★4 Capacities are net, including a deduction for cooling (an addition for heating) for indoor fan motor heat.</p> <p>★5 External static pressure is changeable in 13 stages by remote controller.</p> <p>★6 Air filter is not standard accessory, but please mount it in the duct system of the suction side. Select its dust collection efficiency (gravity method) 50% or more.</p>				<p>★1 Indoor temp.: 80.0°FDB (26.7°CDB), 67.0°FWB (19.4°CWB) / Outdoor temp.: 95.0°FDB (35.0°CDB) / Equivalent piping length: 25 ft (7.6 m) / Level difference: 0</p> <p>★2 Indoor temp.: 70.0°FDB (21.1°CDB) / Outdoor temp.: 47.0°FDB (8.3°CDB), 43.0°FWB (6.1°CWB) / Equivalent piping length: 25 ft (7.6 m) / Level difference: 0</p> <p>★3 Indoor temp.: 70.0°FDB (21.1°CDB) / Outdoor temp.: 17.0°FDB (-8.3°CDB), 15.0°FWB (-9.4°CWB) / Equivalent piping length: 25 ft (7.6 m) / Level difference: 0</p> <p>★4 Capacities are net, including a deduction for cooling (an addition for heating) for indoor fan motor heat.</p> <p>★5 External static pressure is changeable in 11 stages by remote controller.</p> <p>★6 Air filter is not standard accessory, but please mount it in the duct system of the suction side. Select its dust collection efficiency (gravity method) 50% or more.</p>						

Conversion Formulae	
kcal/h = kW × 860	
Btu/h = kW × 3412	
cfm = m ³ /min × 35.3	

Model	Indoor Unit		FDMQ24RVJU	
	Outdoor Unit		RXL24UMVJU	
		Cooling		Heating
Power Supply		1 ϕ , 60 Hz, 208 - 230 V		
Cooling Capacity (Min. ~ Max.) ★4	kW	6.21 (2.64 ~ 7.03) ★1		7.02 (2.64 ~ 8.09) ★2
	Btu/h	21,200 (9,000 ~ 24,000) ★1		24,000 (9,000 ~ 27,600) ★2
	kcal/h	5,340 (2,270 ~ 6,050) ★1		6,050 (2,270 ~ 6,960) ★2
Heating Capacity ★3, ★4	kW	—		4.69
	Btu/h	—		16,000
	kcal/h	—		4,030
COP (Min. ~ Max.)		—		3.80 (5.38 ~ 2.66)
EER (Min. ~ Max.)		12.5 (15.8 ~ 11.4)		—
SEER / HSPF		18.6		10.0
Indoor Unit		FDMQ24RVJU		
Casing Color		—		
Dimensions (H × W × D)		in. (mm) 9-5/8 × 39-3/8 × 31-1/2 (245 × 1,000 × 800)		
Coil	Type	Cross Fin Coil		
	Rows × Stages × Fin per inch	3 × 26 × 18		
	Face Area	ft ² (m ²) 3-1/8 (0.288)		
Fan	Type / Motor Output	W Sirocco Fan / 230		
	Airflow Rate	H / M / L	cfm (m ³ /min)	798 / 678 / 558 (22.6 / 19.2 / 15.8)
	External Static Pressure	inH ₂ O		0.20 (0.60 - 0.20) ★5
		Pa		50 (150 - 50) ★5
Sound Pressure Level		40		40
Sound Power Level		54		54
Air Filter		— ★6		
Weight (Mass) / Gross Weight (Gross Mass)		Lbs (kg) 82 (37) / 88 (40)		
Piping Connections	Liquid	in. (mm) ϕ 1/4 (6.4) (Flare)		
	Gas	in. (mm) ϕ 5/8 (15.9) (Flare)		
	Drain	in. (mm) I.D. ϕ 1 (25) / O.D. ϕ 1-1/4 (32)		
Remote Controller (Option)	Wired		BRC1E73	
	Wireless		BRC082A43	
Outdoor Unit		RXL24UMVJU		
Casing Color		Ivory White		
Dimensions (H × W × D)		in. (mm) 28-15/16 × 34-1/4 × 12-5/8 (735 × 870 × 320)		
Coil	Type	Cross Fin Coil		
	Rows × Stages × Fin per inch	2 × 32 × 18		
	Face Area	ft ² (m ²) 7-1/16 (0.658)		
Compressor	Model		2YC63AAXD	
	Type		Hermetically Sealed Swing Type	
Motor Output		W 1,920		
Fan	Type / Motor Output	W Propeller / 76		
	Airflow Rate	cfm (m ³ /min)	2,418 (68.5)	2,361 (66.9)
Sound Pressure Level		dB(A) 55		55
Sound Power Level		dB(A) 67		67
Weight (Mass) / Gross Weight (Gross Mass)		Lbs (kg) 130 (59) / 137 (62)		
Piping Connections	Liquid	in. (mm) ϕ 1/4 (6.4) (Flare)		
	Gas	in. (mm) ϕ 5/8 (15.9) (Flare)		
	Drain	in. (mm) I.D. ϕ 5/8 (16)		
Safety Devices		Fuse		
Max. Interunit Piping Length		ft (m) 98-1/2 (30)		
Max. Interunit Height Difference		ft (m) 65-5/8 (20)		
Chargeless		ft (m) 32-13/16 (10)		
Amount of Additional Charge of Refrigerant		oz/ft (g/m) 0.32 (30)		
Refrigerant Oil	Type / Charge	FVC50K / 31.75 (0.900)		
Refrigerant	Type / Charge	R-410A / 3.53 (1.60)		
Drawing No.		C: 3D123805		
Notes		<p>★1 Indoor temp.: 80.0°FDB (26.7°CDB), 67.0°FWB (19.4°CWB) / Outdoor temp.: 95.0°FDB (35.0°CDB) / Equivalent piping length: 25 ft (7.6 m) / Level difference: 0</p> <p>★2 Indoor temp.: 70.0°FDB (21.1°CDB) / Outdoor temp.: 47.0°FDB (8.3°CDB), 43.0°FWB (6.1°CWB) / Equivalent piping length: 25 ft (7.6 m) / Level difference: 0</p> <p>★3 Indoor temp.: 70.0°FDB (21.1°CDB) / Outdoor temp.: 17.0°FDB (-8.3°CDB), 15.0°FWB (-9.4°CWB) / Equivalent piping length: 25 ft (7.6 m) / Level difference: 0</p> <p>★4 Capacities are net, including a deduction for cooling (an addition for heating) for indoor fan motor heat.</p> <p>★5 External static pressure is changeable in 11 stages by remote controller.</p> <p>★6 Air filter is not standard accessory, but please mount it in the duct system of the suction side. Select its dust collection efficiency (gravity method) 50% or more.</p>		

Conversion Formulae

$$\begin{aligned} \text{kcal/h} &= \text{kW} \times 860 \\ \text{Btu/h} &= \text{kW} \times 3412 \\ \text{cfm} &= \text{m}^3/\text{min} \times 35.3 \end{aligned}$$

Part 3

Printed Circuit Board Connector Wiring Diagram

1. Indoor Unit.....	22
1.1 FTX09/12NMVJU	22
1.2 FTX15NMVJU	24
1.3 FTX18/24UVJU	26
1.4 FVXS09/12/15NVJU.....	28
1.5 FDMQ12/18/24RVJU	30
2. Wireless Remote Controller Receiver	32
2.1 BRC082A43	32
3. Wired Remote Controller.....	33
3.1 BRC1E73	33
4. Outdoor Unit.....	34
4.1 RXL09QMVJU.....	34
4.2 RXL12QMVJU(9)	36
4.3 RXL15QMVJU.....	38
4.4 RXL18/24UMVJU	39
5. Optional Adaptor	42
5.1 BRP072A43 Wireless LAN Adaptor	42
5.2 KRP067A41/KRP980B2 Remote Control PC-board Set.....	42

1. Indoor Unit

1.1 FTX09/12NMVJU

Control PCB (PCB1)

- | | |
|-------------------|--|
| 1) S6 | Connector for swing motor (horizontal blade) |
| 2) S26 | Connector for display/signal receiver PCB (PCB2) |
| 3) S32 | Connector for indoor heat exchanger thermistor (R2T) |
| 4) S200 | Connector for DC fan motor |
| 5) S403 | Connector for adaptor PCB (option) |
| 6) H1, H2, H3, FG | Connector for terminal strip |
| 7) FU1 | Fuse (3.15 A, 250 V) |
| 8) V2 | Varistor |

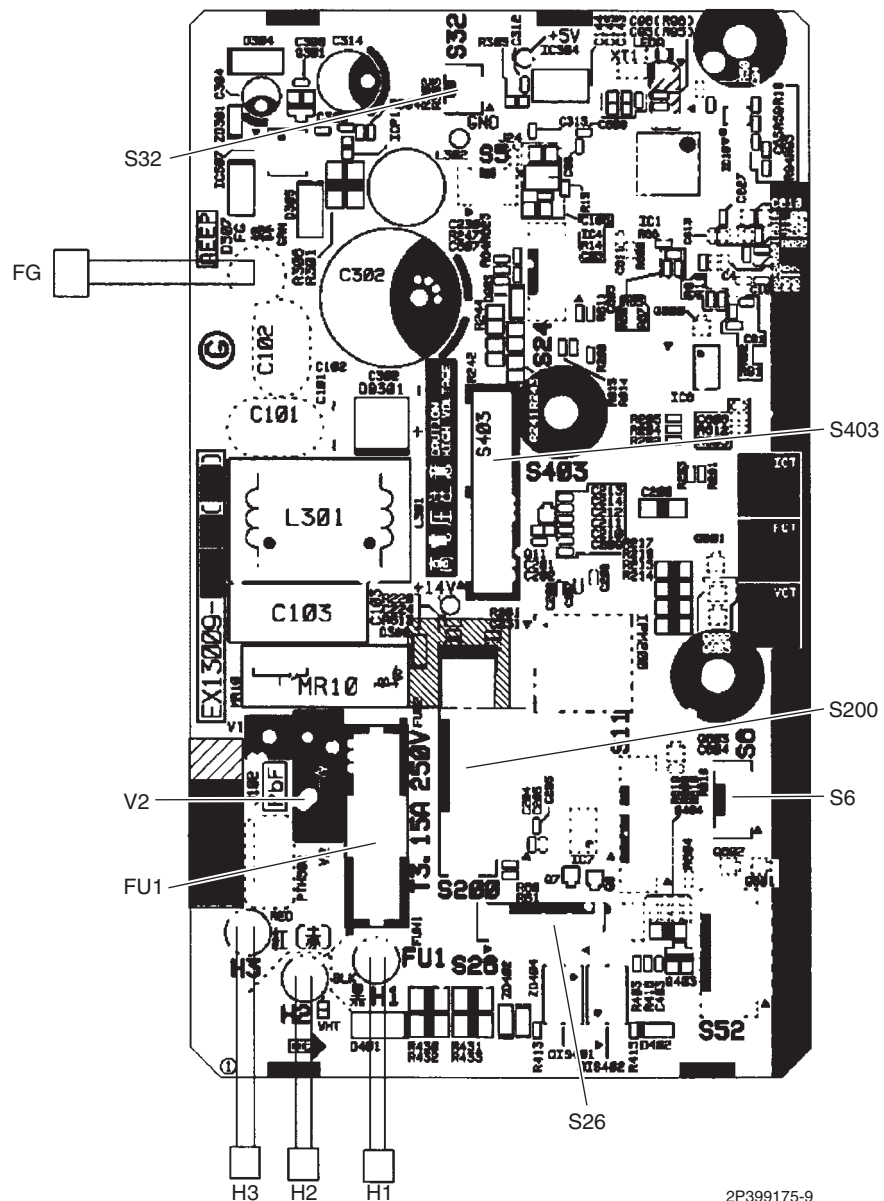

**Display/Signal
Receiver PCB
(PCB2)**

- | | | |
|----|------------|---|
| 1) | S27 | Connector for control PCB (PCB1) |
| 2) | SW1 (S1W) | Indoor unit ON/OFF switch
(Forced cooling operation ON/OFF switch)
Refer to page 199 for details of forced cooling operation. |
| 3) | LED1 (H1P) | LED for operation (green) |
| 4) | LED2 (H2P) | LED for timer (yellow) |
| 5) | RTH1 (R1T) | Room temperature thermistor |

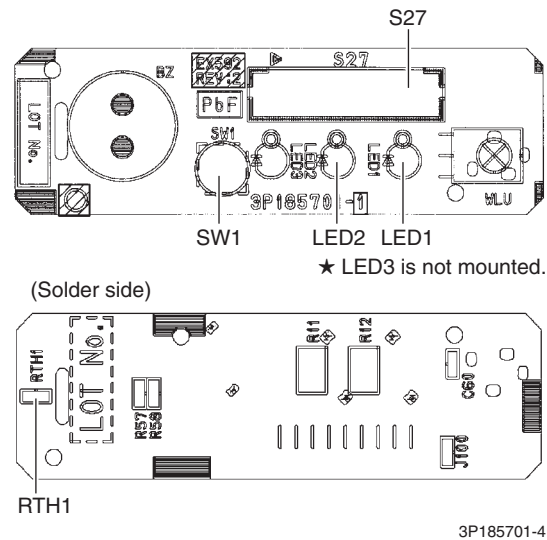

Note

The symbols in the parenthesis are the names on the appropriate wiring diagram.

1.2 FTX15NMVJU

Control PCB (PCB2)

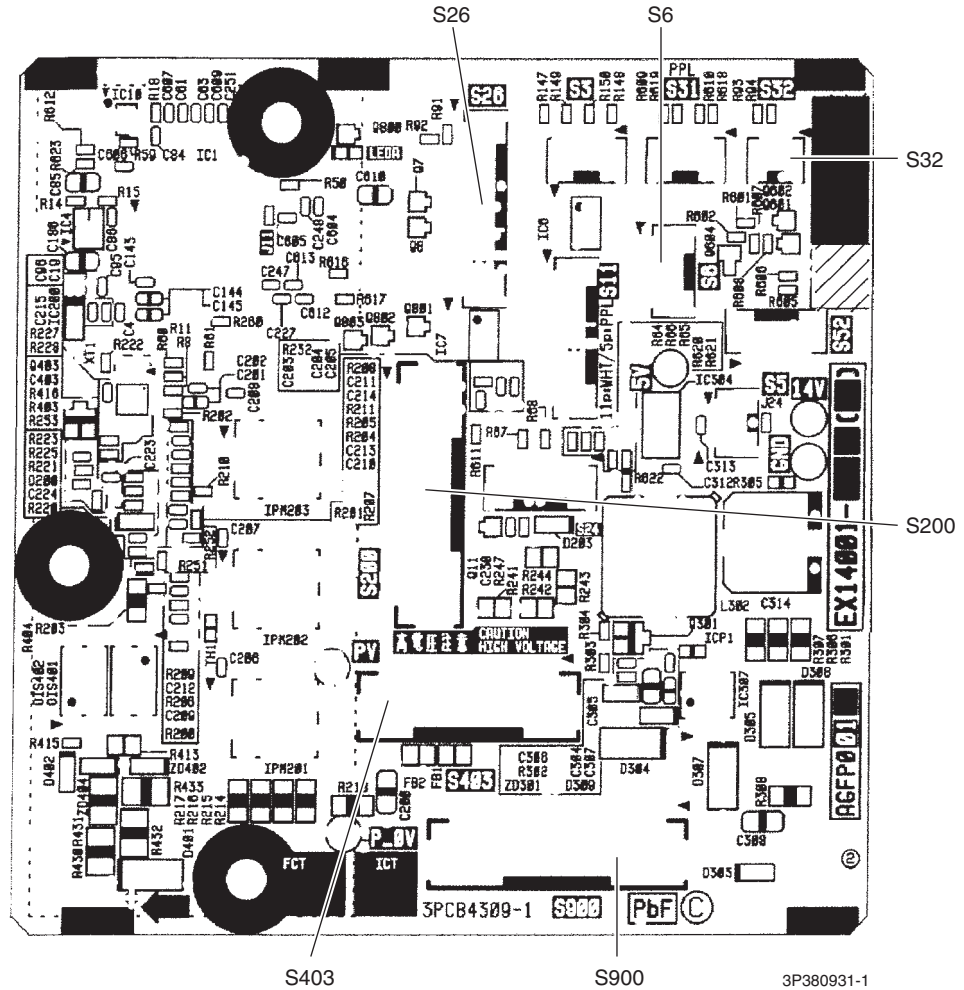
- 1) S6 Connector for swing motor (horizontal blade)
- 2) S26 Connector for display/signal receiver PCB (PCB3)
- 3) S32 Connector for indoor heat exchanger thermistor (R2T)
- 4) S200 Connector for DC fan motor
- 5) S403 Connector for adaptor PCB (option)
- 6) S900 Connector for filter PCB (PCB1)



Filter PCB (PCB1)

- 1) S100 Connector for terminal strip
- 2) S800 Connector for control PCB (PCB2)
- 3) FG, HE Connector for ground
- 4) FU1 Fuse (3.15 A, 250 V)
- 5) V2 Varistor

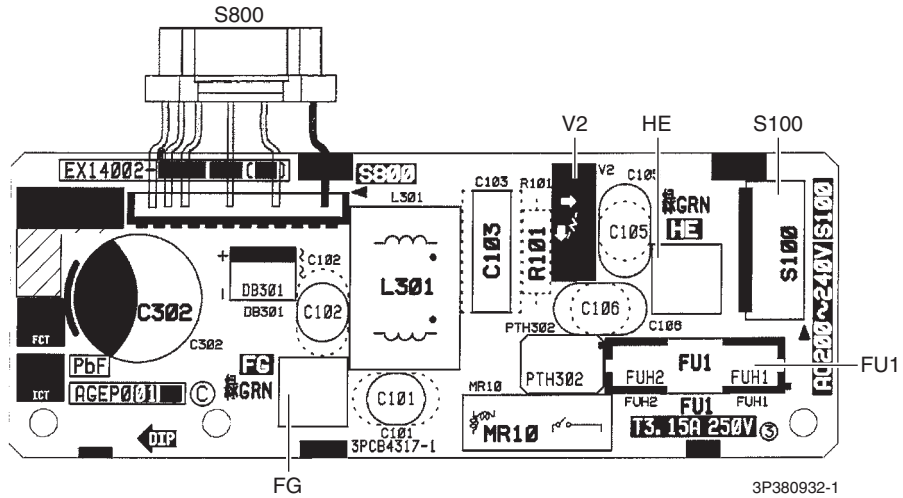

Display/Signal Receiver PCB (PCB3)

- 1) S27 Connector for control PCB (PCB2)
- 2) SW1 (S1W) Indoor unit **ON/OFF** switch
(Forced cooling operation **ON/OFF** switch)
Refer to page 199 for details of forced cooling operation.
- 3) LED1 (H1P) LED for operation (green)
- 4) LED2 (H2P) LED for timer (yellow)
- 5) RTH1 (R1T) Room temperature thermistor

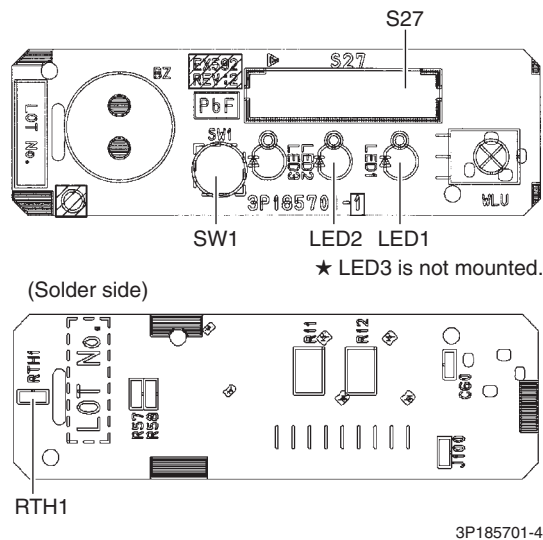

Note

The symbols in the parenthesis are the names on the appropriate wiring diagram.

1.3 FTX18/24UVJU

Control PCB (PCB1)

- | | | |
|-----|-------------------------|--|
| 1) | S1 | Connector for DC fan motor |
| 2) | S21 | Connector for centralized control (HA) |
| 3) | S25 | Connector for INTELLIGENT EYE sensor PCB (PCB4) |
| 4) | S32 | Indoor heat exchanger thermistor (R2T) |
| 5) | S41 | Connector for swing motors |
| 6) | S46 | Connector for display PCB (PCB3) |
| 7) | S47 | Connector for signal receiver PCB (PCB2) |
| 8) | H1, H2, H3, FG | Connector for terminal strip |
| 9) | JA | Address setting jumper
Refer to page 207 for details. |
| 10) | JB | Fan speed setting when compressor stops for thermostat OFF
Refer to page 209 for details. |
| 11) | JC | Power failure recovery function (auto-restart)
Refer to page 209 for details. |
| 12) | LED A | LED for service monitor (green) |
| 13) | FU1 (F1U),
FU2 (F2U) | Fuse (3.15 A, 250 V) |
| 14) | V1 | Varistor |

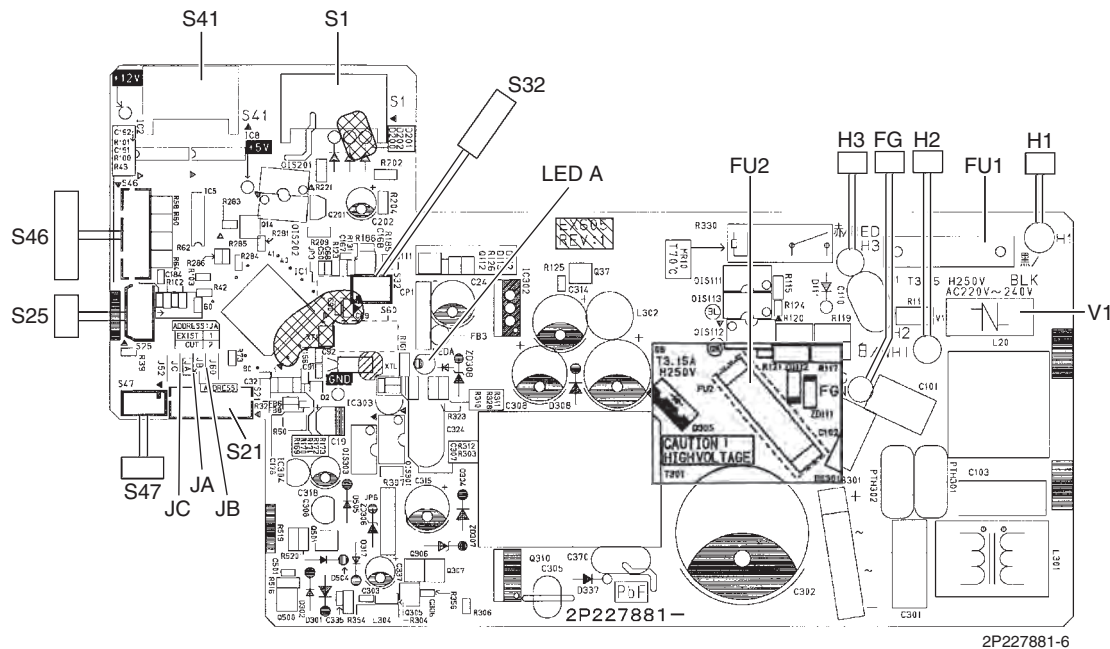

Caution

Replace the PCB if you cut a jumper unintentionally.

Jumpers are necessary for electronic circuit. Improper operation may occur if you cut any of them.



Note

The symbols in the parenthesis are the names on the appropriate wiring diagram.

**Signal Receiver
PCB (PCB2)**

- 1) S48 Connector for control PCB (PCB1)

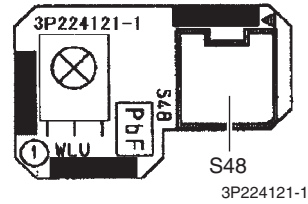
**Display PCB
(PCB3)**

- 1) S49 Connector for control PCB (PCB1)
 2) SW1 Indoor unit **ON/OFF** switch
 (Forced cooling operation **ON/OFF** switch)
 Refer to page 199 for details of forced cooling operation.
 3) LED1 (H1P) LED for operation (green)
 4) LED2 (H2P) LED for timer (yellow)
 5) LED3 (H3P) LED for INTELLIGENT EYE (green)
 6) RTH1 (R1T) Room temperature thermistor

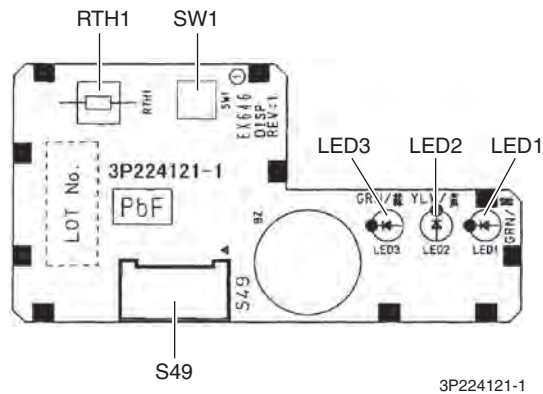
**INTELLIGENT
EYE Sensor PCB
(PCB4)**

- 1) S36 Connector for control PCB (PCB1)

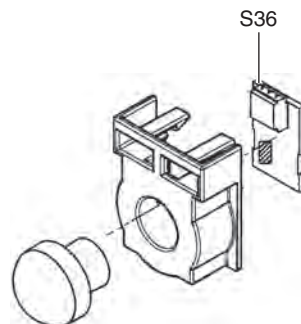

3P227885-1

**Note**

The symbols in the parenthesis are the names on the appropriate wiring diagram.

1.4 FVXS09/12/15NVJU

Control PCB (PCB2)

- | | | |
|-----|-------------------------|--|
| 1) | S1 | Connector for DC fan motor |
| 2) | S21 | Connector for centralized control (HA) |
| 3) | S26 | Connector for service PCB (PCB3) |
| 4) | S32 | Indoor heat exchanger thermistor (R2T) |
| 5) | S41 | Connector for lower air outlet motor |
| 6) | S42 | Connector for swing motor |
| 7) | S46 | Connector for display/signal receiver PCB (PCB4) |
| 8) | S48 | Connector for sensor PCB (PCB1) |
| 9) | H1, H2, H3 | Connector for terminal strip |
| 10) | E1 | Terminal for ground wire |
| 11) | JA | Address setting jumper |
| | | Refer to page 207 for details. |
| 12) | JB | Fan speed setting when compressor stops for thermostat OFF |
| | | Refer to page 209 for details. |
| 13) | JC | Power failure recovery function |
| | | Refer to page 209 for details. |
| 14) | FU1 (F1U),
FU2 (F2U) | Fuse (3.15 A, 250 V) |
| 15) | LED A | LED for service monitor (green) |
| 16) | V1, V2 | Varistor |

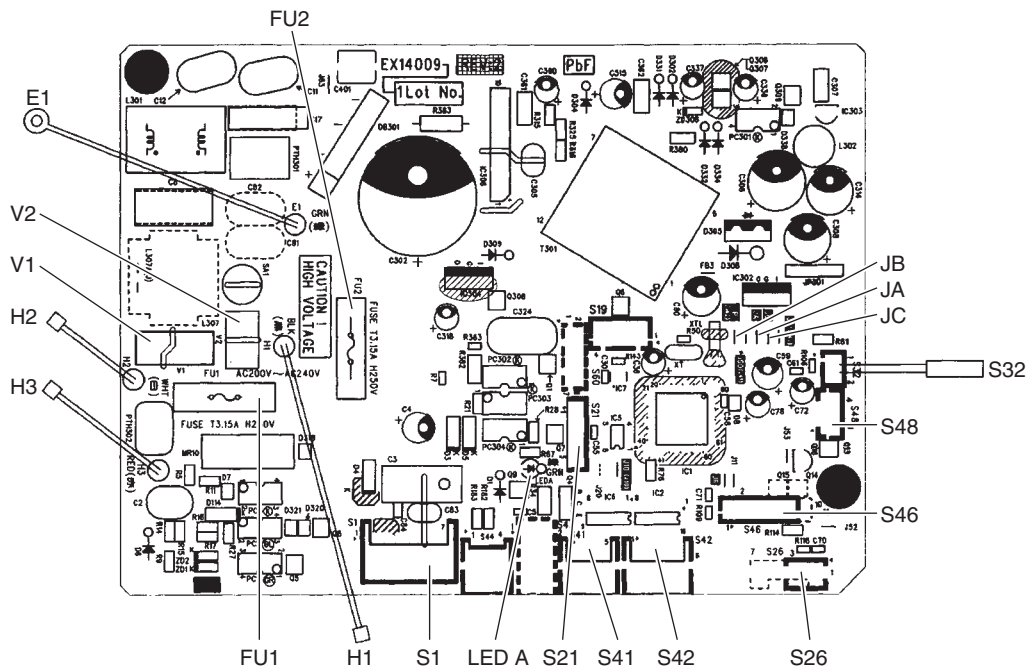

2P383711-1

**Caution**

Replace the PCB if you cut a jumper unintentionally.

Jumpers are necessary for electronic circuit. Improper operation may occur if you cut any of them.

**Note**

The symbols in the parenthesis are the names on the appropriate wiring diagram.

**Sensor PCB
(PCB1)**

- | | | |
|----|------------|----------------------------------|
| 1) | S49 | Connector for control PCB (PCB2) |
| 2) | RTH2 (R1T) | Room temperature thermistor |

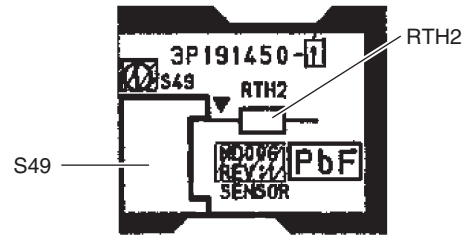

3P191450-1

**Service PCB
(PCB3)**

- | | | |
|----|-------------|--|
| 1) | S27 | Connector for control PCB (PCB2) |
| 2) | SW2 (S2W)-4 | Switch for upward airflow limit setting
Refer to page 209 for details.
* Keep the other switches as factory setting. |
| 3) | SW4 (S4W) | Switch for airflow selection
Refer to page 46 for details. |

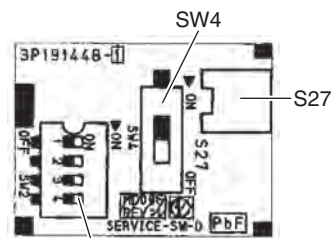

3P191448-1

**Display/Signal
Receiver PCB
(PCB4)**

- | | | |
|----|------------|---|
| 1) | S47 | Connector for control PCB (PCB2) |
| 2) | SW1 (S1W) | Indoor unit ON/OFF switch
(Forced cooling operation ON/OFF switch)
Refer to page 199 for details of forced cooling operation. |
| 3) | LED1 (H1P) | LED for operation (green) |
| 4) | LED2 (H2P) | LED for timer (yellow) |

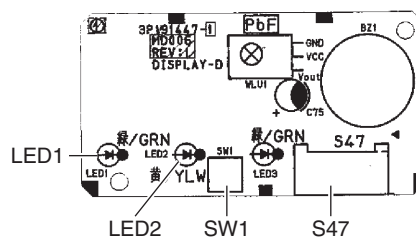

3P191447-1

★ LED3 does not function.

**Note**

The symbols in the parenthesis are the names on the appropriate wiring diagram.

1.5 FDMQ12/18/24RVJU

Control PCB (A1P)

- | | | |
|-----|------------|--|
| 1) | X15A | Connector for float switch |
| 2) | X16A | Connector for room temperature thermistor (suction air thermistor) (R1T) |
| 3) | X17A, X18A | Connector for indoor heat exchanger thermistor (R2T, R3T) |
| 4) | X25A | Connector for drain pump motor |
| 5) | X27A | Connector for terminal block (for power supply) |
| 6) | X28A | Connector for power supply wiring (option) |
| 7) | X30A | Connector for terminal block (for wired remote controller) |
| 8) | X33A | Connector for wiring (option) |
| 9) | X35A | Connector for wiring adaptor (option) |
| 10) | X70A | Connector for indoor fan PCB (A2P) |
| 11) | F1U | Fuse (3.15 A, 250 V) |
| 12) | HAP | LED for service monitor (green) |
| 13) | DS1 | DIP switch for emergency |

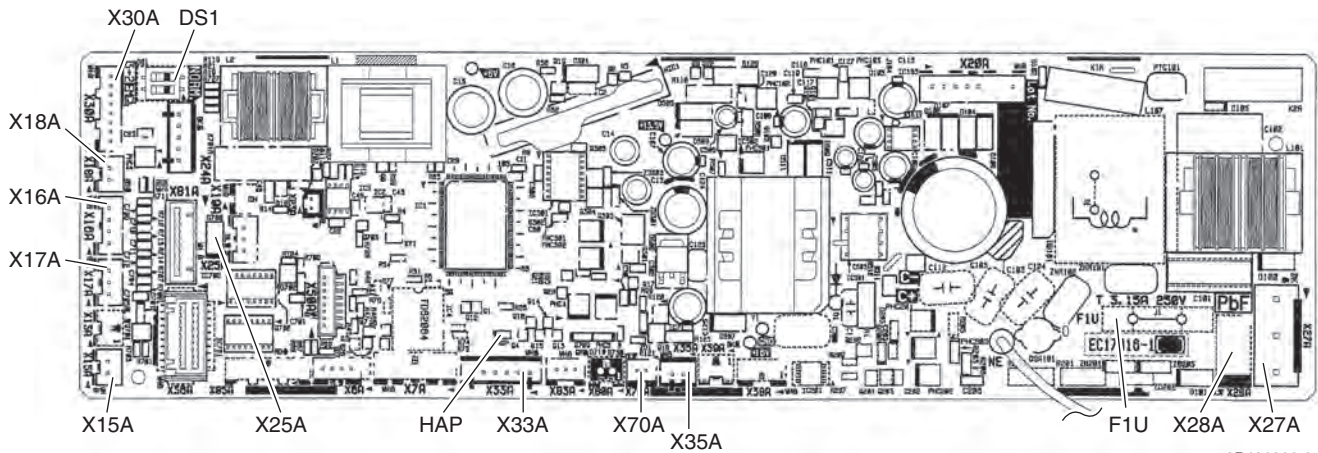

2P486802-2

**Indoor Fan PCB
(A2P)**

- 1) X3A Connector for control PCB (A1P)
- 2) X6A Connector for reactor
- 3) X8A Connector for DC fan motor
- 4) X10A Connector for terminal block (for power supply)
- 5) F2U Fuse (5 A, 250 V)
- 6) F4U Fuse (6.3 A, 250 V)
- 7) HAP LED for service monitor (green)

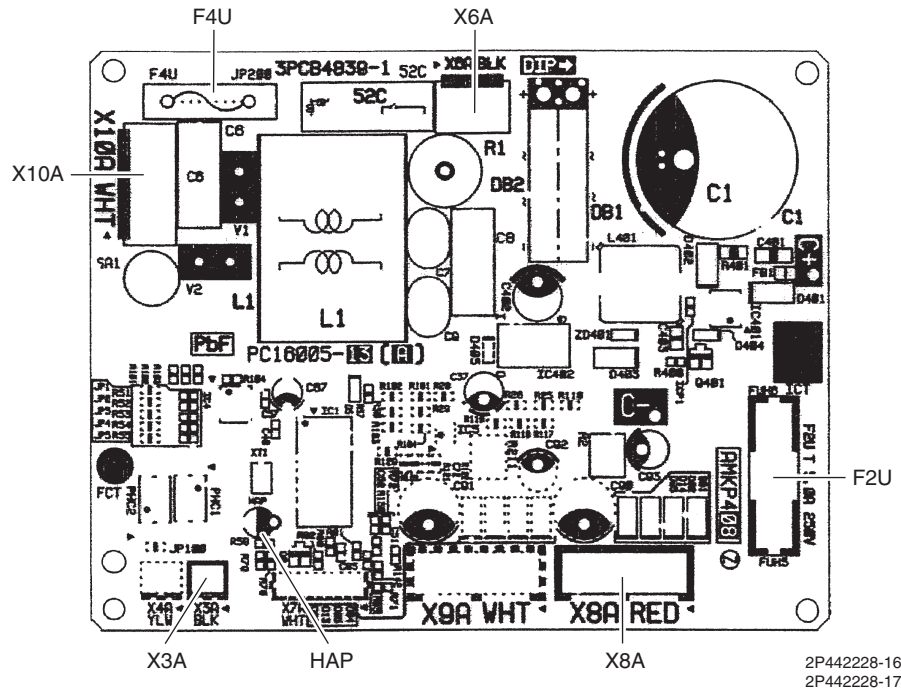

2P442228-16
2P442228-17

2. Wireless Remote Controller Receiver

2.1 BRC082A43

Wired Remote Controller PCB

- 1) SS1 MAIN/SUB setting switch
Refer to page 214 for details.
- 2) SS2 Address setting switch
Refer to page 214 for details.
- 3) P1, P2 Terminal for indoor unit control PCB (A1P)

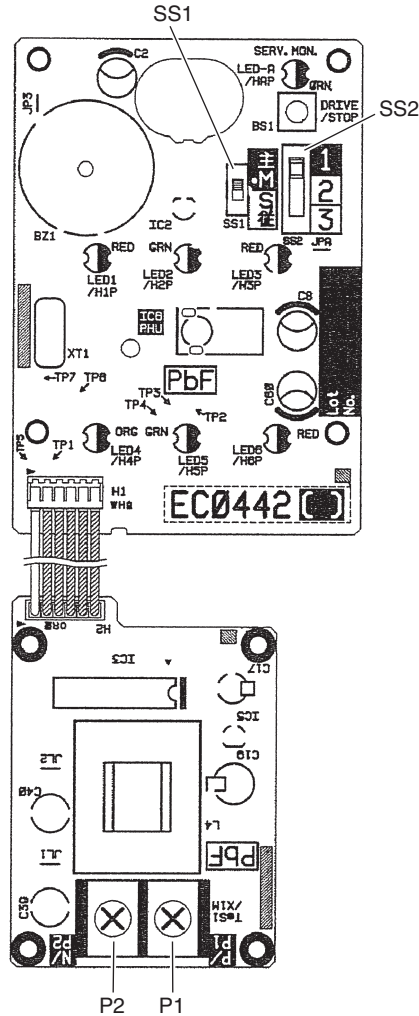

3P156152-1

3. Wired Remote Controller

3.1 BRC1E73

Wired Remote Controller PCB

- 1) P1, P2 Terminal for indoor unit
- 2) R4T Room temperature thermistor

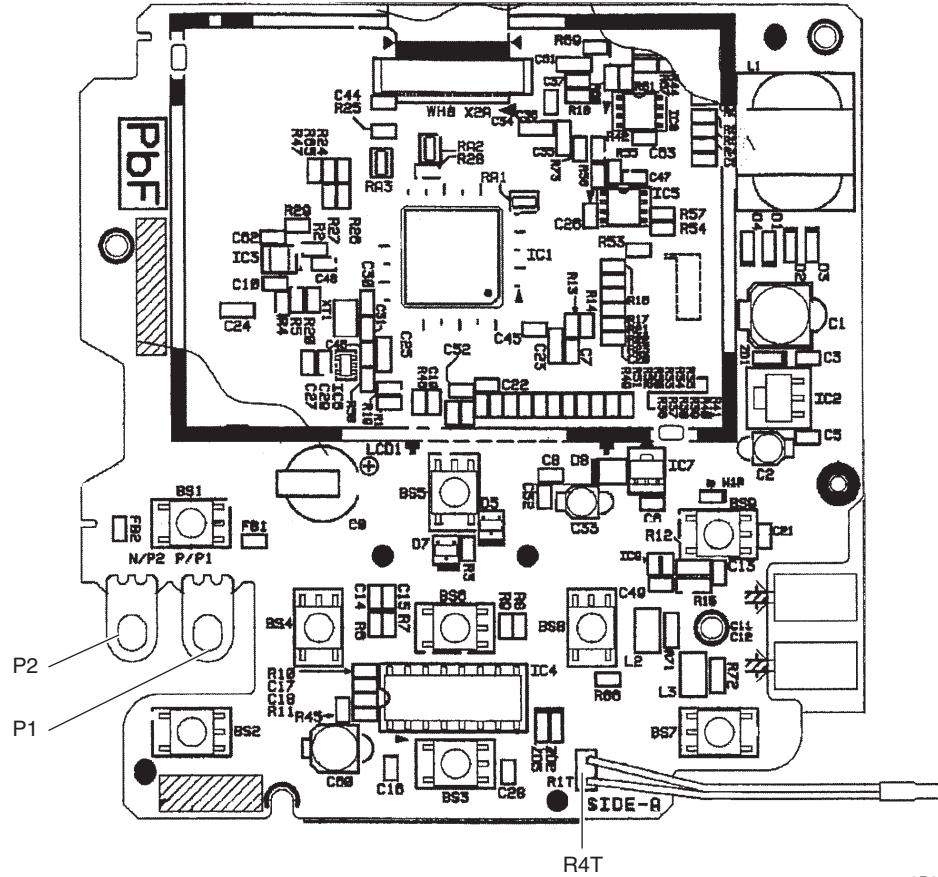

2P298037-7

4. Outdoor Unit

4.1 RXL09QMVJU

Main PCB (PCB1)

1)	S20	Connector for electronic expansion valve coil
2)	S30	Connector for compressor
3)	S40	Connector for overload protector
4)	S71	Connector for DC fan motor
5)	S80	Connector for four way valve coil
6)	S90	Connector for thermistors (outdoor temperature, outdoor heat exchanger, discharge pipe)
7)	HL1, HN1, S	Connector for terminal block
8)	E1, E2	Terminal for ground wire
9)	HR1, HR2	Connector for reactor
10)	FU1, FU2	Fuse (3.15 A, 250 V)
11)	FU3	Fuse (20 A, 250 V)
12)	J6	Jumper for facility setting Refer to page 217 for details.
13)	LED A	LED for service monitor (green)
14)	V2, V3, V150	Varistor

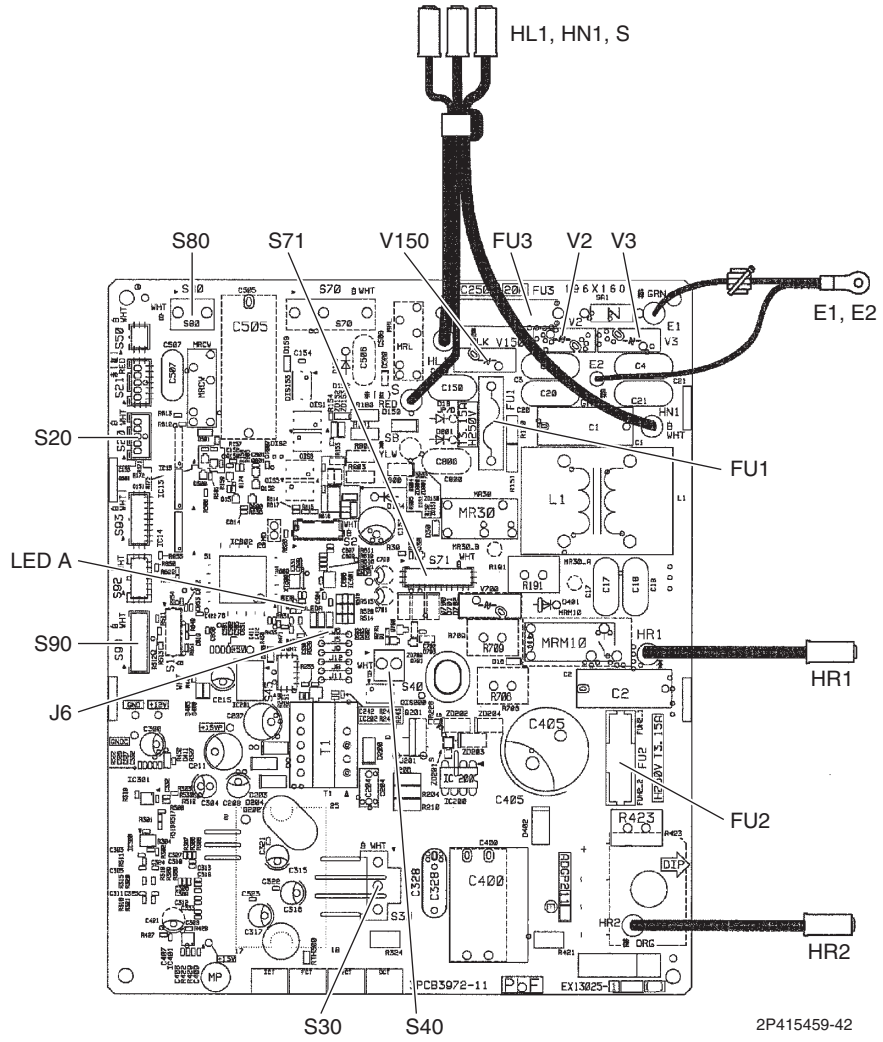

 **Caution**

Replace the PCB if you cut a jumper unintentionally.

Jumpers are necessary for electronic circuit. Improper operation may occur if you cut any of them.

4.2 RXL12QMVJU(9)

Main PCB

1)	S20	Connector for electronic expansion valve coil
2)	S40	Connector for overload protector
3)	S70	Connector for DC fan motor
4)	S80	Connector for four way valve coil
5)	S90	Connector for thermistors (outdoor temperature, outdoor heat exchanger, discharge pipe)
6)	HL1, HN1, S	Connector for terminal block
7)	E1, E2	Terminal for ground wire
8)	U, V, W	Connector for compressor
9)	FU1, FU2	Fuse (3.15 A, 250 V)
10)	FU3	Fuse (20 A, 250 V)
11)	J6	Jumper for facility setting Refer to page 217 for details.
12)	LED A	LED for service monitor (green)
13)	V2, V3, V150	Varistor

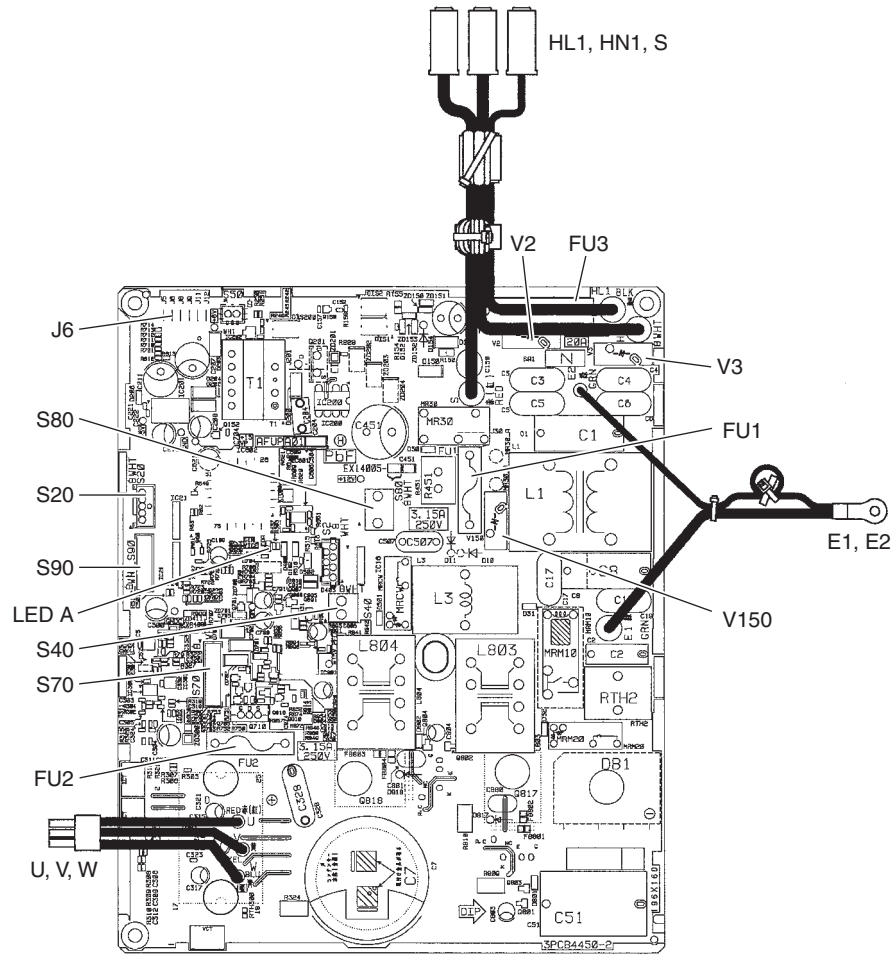

2P381219-4
2P575834-12



Caution

Replace the PCB if you cut a jumper unintentionally.

Jumpers are necessary for electronic circuit. Improper operation may occur if you cut any of them.

4.3 RXL15QMVJU

Main PCB

- | | | |
|-----|-------------|--|
| 1) | S20 | Connector for electronic expansion valve coil |
| 2) | S40 | Connector for overload protector |
| 3) | S70 | Connector for DC fan motor |
| 4) | S80 | Connector for four way valve coil |
| 5) | S90 | Connector for thermistors
(outdoor temperature, outdoor heat exchanger, discharge pipe) |
| 6) | HL1, HN1, S | Connector for terminal block |
| 7) | E1, E2 | Terminal for ground wire |
| 8) | U, V, W | Connector for compressor |
| 9) | FU1, FU2 | Fuse (3.15 A, 250 V) |
| 10) | FU3 | Fuse (30 A, 250 V) |
| 11) | J6 | Jumper for facility setting
Refer to page 217 for details. |
| 12) | LED A | LED for service monitor (green) |
| 13) | V1, V2, V3 | Varistor |

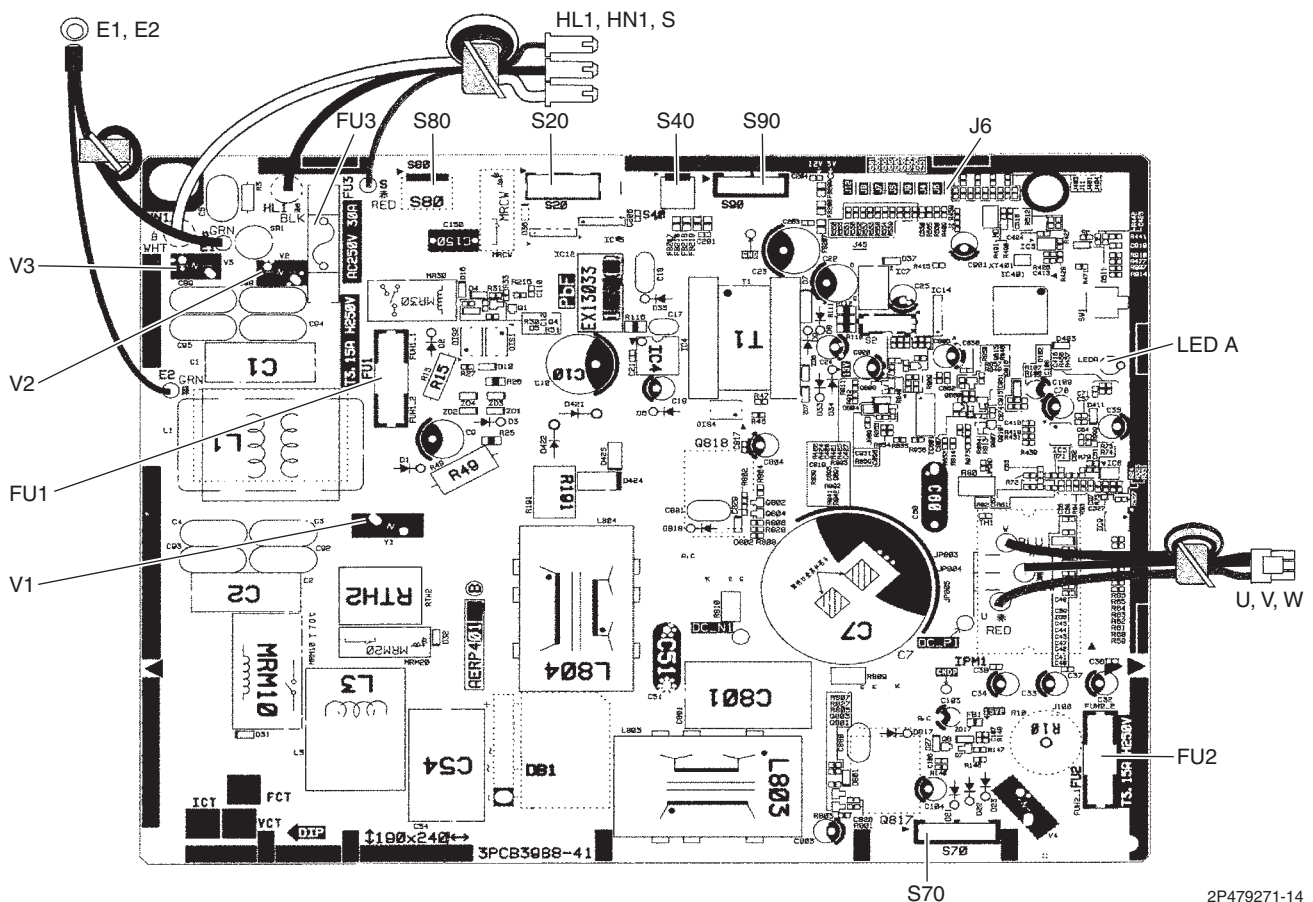

Caution

Replace the PCB if you cut a jumper unintentionally.

Jumpers are necessary for electronic circuit. Improper operation may occur if you cut any of them.

4.4 RXL18/24UMVJU

Main PCB (PCB1)

1)	S	Connector for terminal block (indoor - outdoor transmission)
2)	S20	Connector for electronic expansion valve coil (White)
3)	S40	Connector for overload protector
4)	S70	Connector for DC fan motor
5)	S80	Connector for four way valve coil
6)	S90	Connector for thermistors (outdoor temperature, outdoor heat exchanger, discharge pipe)
7)	S201, 202	Connector for service monitor PCB (PCB2)
8)	CK1	Connector for voltage endurance test
9)	HL1, HN1	Connector for terminal block (power supply)
10)	E1, E2	Terminals for ground wire
11)	U, V, W	Connector for compressor
12)	FU1, FU2	Fuse (3.15 A, 250 V)
13)	FU3	Fuse (30 A, 250 V)
14)	V2, V3, V401	Varistor

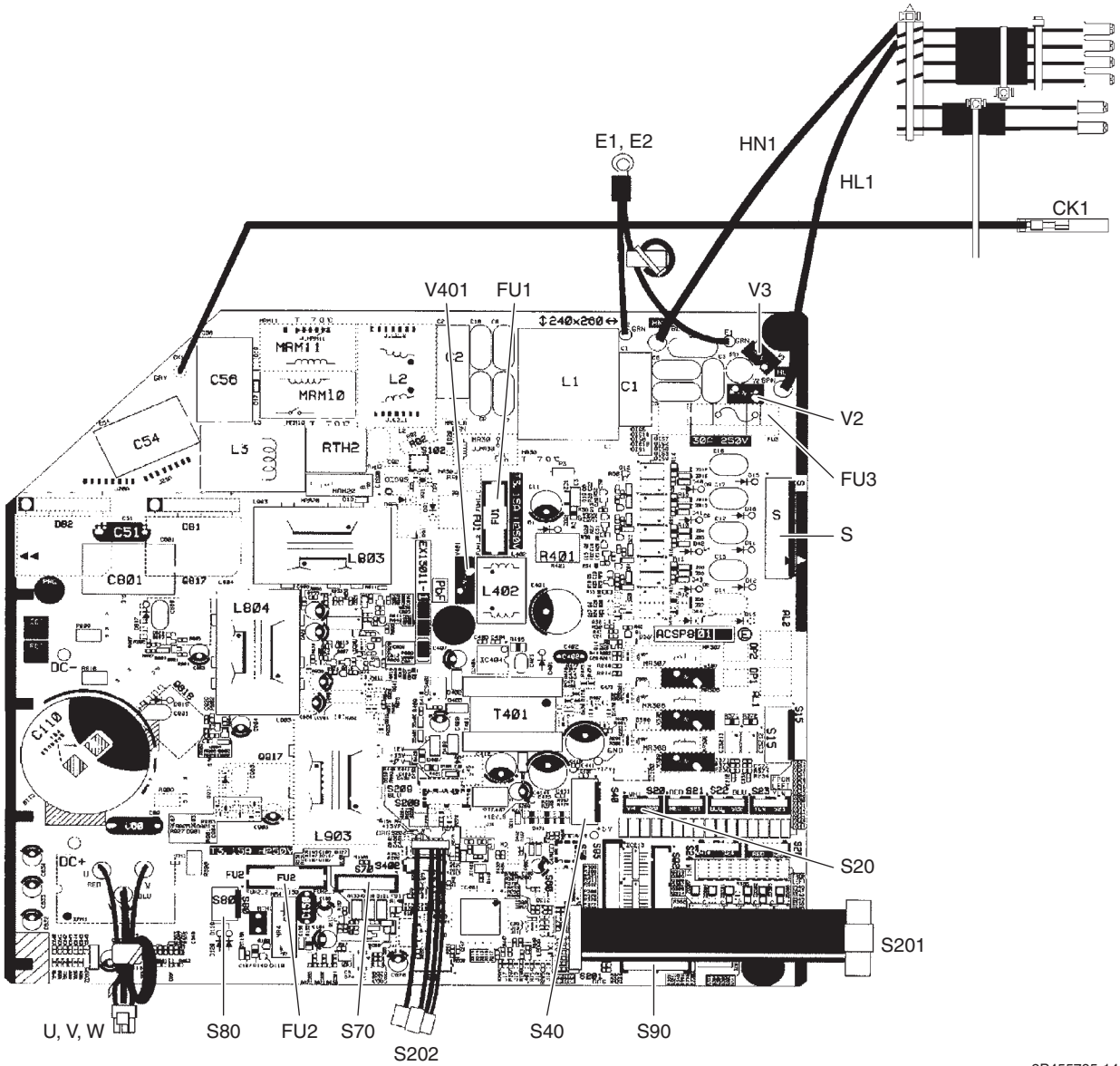

2P455785-14

**Service Monitor
PCB (PCB2)**

- 1) S501, S502 Connector for main PCB (PCB1)
- 2) LED A LED for service monitor (green)
- 3) SW5-3 Switch for facility setting
Refer to page 217 for details.
- 4) SW6-1 Switch for drain pan heater
Refer to page 218 for details.

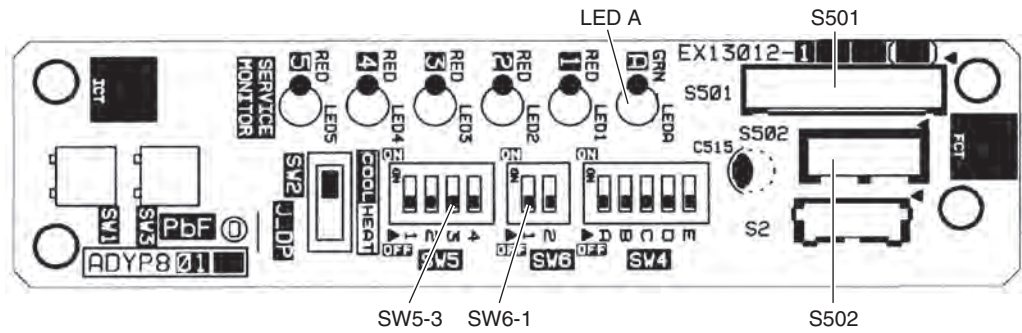

3P346711-10

★ SW1 ~ SW4 and LED1 ~ LED5 do not work.

5. Optional Adaptor

5.1 BRP072A43 Wireless LAN Adaptor

Wireless LAN
Adaptor PCB

- 1) CN1 Connector for [S21] or [S403]

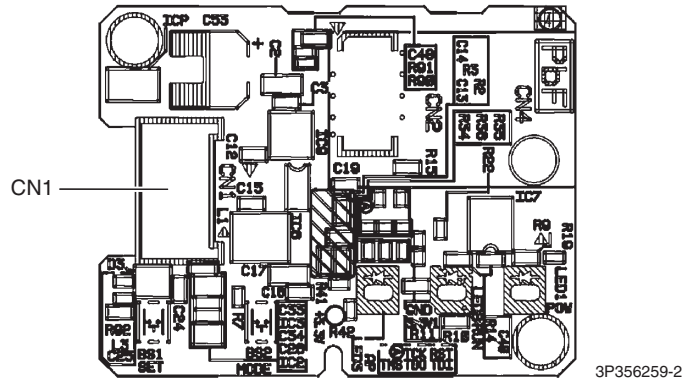

Note

★ Connectors

Models	Connector
FTX09/12/15NMVJU	S403
FTX18/24UVJU	S21
FVXS series	S21

5.2 KRP067A41/KRP980B2 Remote Control PC-board Set

Adaptor PCB

- 1) S21 Connector for wireless LAN adaptor PCB
- 2) S601, S602 Connector for [S403] on indoor unit control PCB

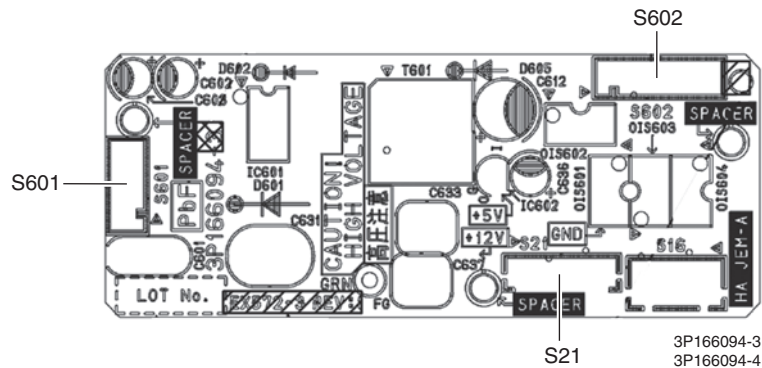

Part 4

Functions and Control

1. Common Functions	44
1.1 Temperature Control	44
1.2 Frequency Principle.....	44
2. Functions for FTX, FVXS Series	46
2.1 Airflow Direction Control.....	46
2.2 COMFORT AIRFLOW Operation	49
2.3 Fan Speed Control for Indoor Unit	50
2.4 Program Dry Operation	51
2.5 Automatic Cooling/Heating Changeover	52
2.6 Thermostat Control.....	53
2.7 NIGHT SET Mode	54
2.8 ECONO Operation	55
2.9 INTELLIGENT EYE Operation	56
2.10 POWERFUL Operation	57
2.11 Clock Setting	58
2.12 WEEKLY TIMER Operation	59
2.13 Other Functions.....	65
3. Functions for FDMQ Series.....	66
3.1 Fan Speed Control for Indoor Unit	66
3.2 Program Dry Operation	67
3.3 Clock and Calender Setting (With BRC1E73).....	68
3.4 Schedule Timer Operation (With BRC1E73).....	70
3.5 Drain Pump Control.....	73
3.6 Hot Start Control (In Heating Operation Only).....	75
3.7 Other Functions.....	76
4. Thermistor Functions	77
5. Control Specification	78
5.1 Mode Hierarchy	78
5.2 Frequency Control.....	78
5.3 Controls at Mode Changing/Start-up.....	80
5.4 Discharge Pipe Temperature Control.....	82
5.5 Input Current Control.....	83
5.6 Freeze-up Protection Control	84
5.7 Heating Peak-cut Control	84
5.8 Outdoor Fan Control.....	85
5.9 Liquid Compression Protection Function.....	85
5.10 Defrost Control	86
5.11 Electronic Expansion Valve Control	87
5.12 Malfunctions	90

1. Common Functions

1.1 Temperature Control

Definitions of Temperatures

The definitions of temperatures are classified as following.

- Room temperature: temperature of lower part of the room
- Set temperature: temperature set by remote controller
- Room thermistor temperature: temperature detected by room temperature thermistor
- Target temperature: temperature determined by microcomputer

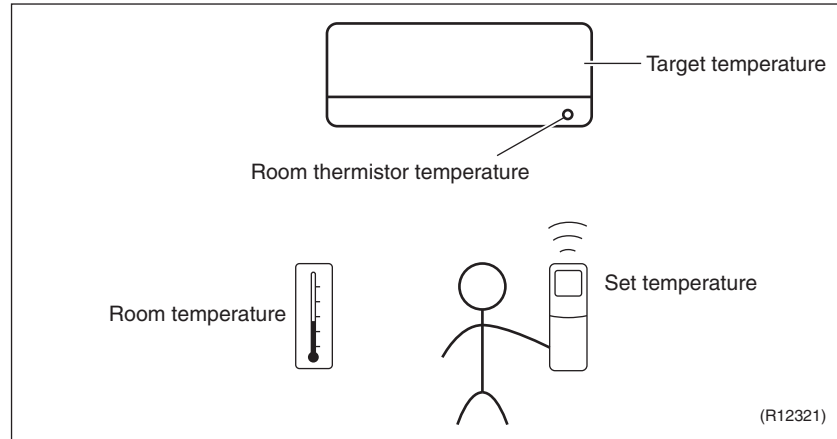

★ The illustration is for wall mounted type as representative.

Temperature Control

The temperature of the room is detected by the room temperature thermistor. However, there is a difference between the temperature detected by room temperature thermistor and the temperature of lower part of the room, depending on the type of the indoor unit or installation condition. In practice, the temperature control is done by the target temperature appropriately adjusted for the indoor unit and the temperature detected by room temperature thermistor.

1.2 Frequency Principle

Control Parameters

The frequency of the compressor is controlled by the following 2 parameters:

- The load condition of the operating indoor unit
- The difference between the room thermistor temperature and the target temperature

The target frequency is adapted by additional parameters in the following cases:

- Frequency restrictions
- Initial settings
- Forced cooling operation

Inverter Principle

To regulate the capacity, a frequency control is needed. The inverter makes it possible to control the rotation speed of the compressor. The followings explain the inverter principle:

Phase 1

The supplied AC power source is converted into the DC power source for the present.

Phase 2

The DC power source is reconverted into the three phase AC power source with variable frequency.

- When the frequency increases, the rotation speed of the compressor increases resulting in an increase of refrigerant circulation. This leads to a larger amount of heat exchange per unit.
- When the frequency decreases, the rotation speed of the compressor decreases resulting in a decrease of refrigerant circulation. This leads to a smaller amount of heat exchange per unit.

The following drawing shows a schematic view of the inverter principle:

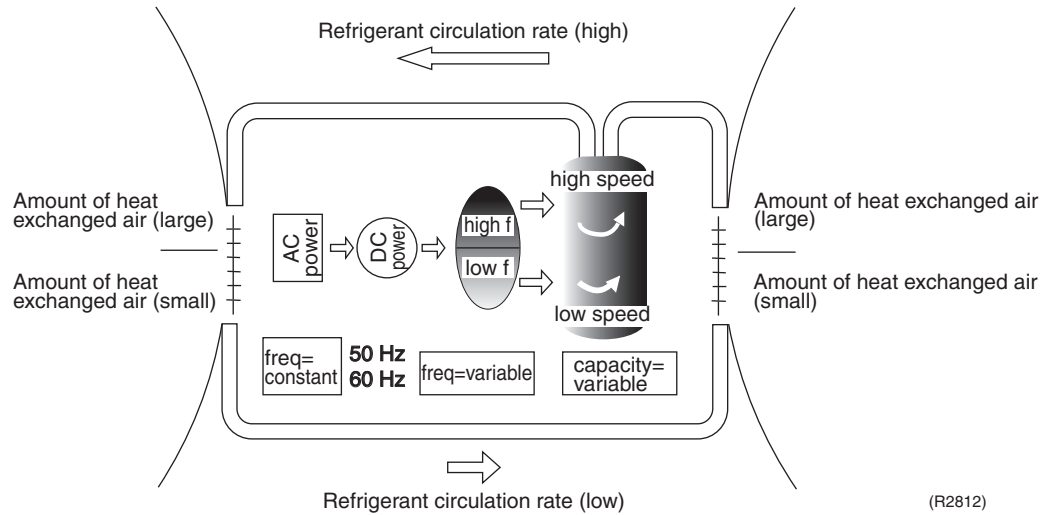

Inverter Features

The inverter provides the following features:

- The regulating capacity can be changed according to the changes in the outdoor temperature and cooling/heating load.
- Quick heating and quick cooling
The rotation speed of the compressor is increased when starting the heating (cooling). This enables to reach the set temperature quickly.
- Even during extreme cold weather, high capacity is achieved. It is maintained even when the outdoor temperature is 2°C (35.6°F).
- Comfortable air conditioning
A fine adjustment is integrated to keep the room temperature constant.
- Energy saving heating and cooling
Once the set temperature is reached, the energy saving operation enables to maintain the room temperature at low power.

Frequency Limits

The following functions regulate maximum frequency:

Low frequency

- Four way valve operation compensation. Refer to page 81.

High frequency

- Compressor protection function. Refer to page 81.
- Discharge pipe temperature control. Refer to page 82.
- Input current control. Refer to page 83.
- Freeze-up protection control. Refer to page 84.
- Heating peak-cut control. Refer to page 84.
- Defrost control. Refer to page 86.

Forced Cooling Operation

Refer to page 199 for details.

2. Functions for FTX, FVXS Series

2.1 Airflow Direction Control

Power-Airflow (Dual) Flap(s)

The large flap sends a large volume of air downward to the floor and provides an optimum control in cooling, dry and heating operation.

Cooling/Dry

During cooling or dry operation, the flap retracts into the indoor unit. Then, cool air can be blown far and distributed all over the room.

Heating

During heating operation, the large flap directs airflow downward to spread the warm air to the entire room.



Wide-Angle Louvers

The louvers, made of elastic synthetic resin, provide a wide range of airflow that guarantees comfortable air distribution.

Auto-Swing

The following tables explain the auto-swing process for cooling, dry, heating and fan:

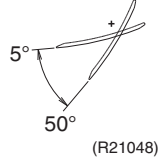
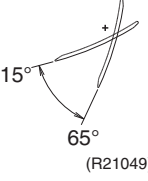
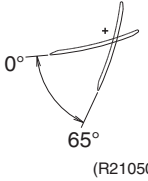
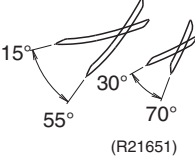
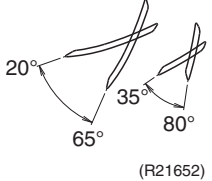
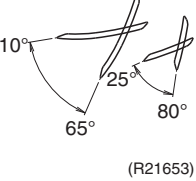
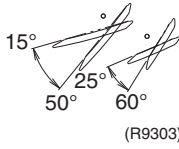
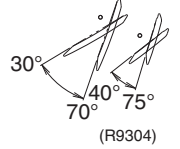
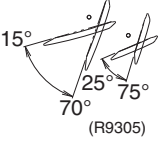
FTX series

	Flap (up and down)			Louver (right and left)
	Cooling/Dry	Heating	Fan	
09/12 class	 5° 50° (R21048)	 15° 65° (R21049)	 0° 65° (R21050)	—
15 class	 15° 55° 70° (R21651)	 20° 65° 35° 80° (R21652)	 10° 65° 25° 80° (R21653)	—
18/24 class	 15° 50° 25° 60° (R9303)	 30° 70° 40° 75° (R9304)	 15° 70° 25° 75° (R9305)	 45° 45° (R9306)

FVXS series

	Flap (up and down)	
	Cooling/Dry	Heating
Upward airflow limit OFF	 R4003397	 R4003396
Upward airflow limit ON	 R4003394	 R4003394

3-D Airflow

FTX18/24UVJU only

Alternative repetition of vertical and horizontal swing motions enables uniform air-conditioning of the entire room.

When the horizontal swing and vertical swing are both set to automatic operation, the airflow becomes 3-D airflow. The horizontal and vertical swing motions are alternated and the airflow direction changes in the order shown in the following diagram.

- (1) The vertical blades (louvers) move from the right to the left.
- (2) The horizontal blades (flaps) move downward.
- (3) The vertical blades (louvers) move from the left to the right.
- (4) The horizontal blades (flaps) move upward.

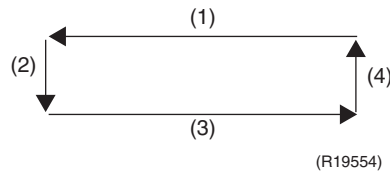

Airflow Selection Setting

FVXS Series

Airflow direction can be set with the airflow selection switch.

- Open the front panel.

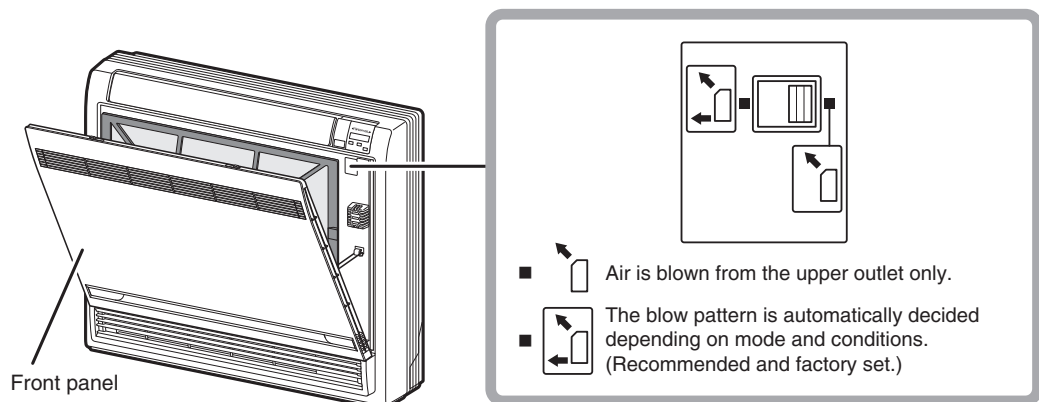

(R17866)









Caution

Before opening the front panel, be sure to stop the operation and turn the breaker off. Do not touch the aluminum fins (indoor heat exchanger) inside the indoor unit, as it may result in injury.

When setting the airflow selection switch to .

- The air conditioner automatically decides the appropriate blowing pattern depending on the operating mode/situation.

Operating mode	Situation	Blowing pattern	
Cooling	When the operation is activated or when the room is not fully cooled.		Air is blown from the upper and lower air outlets in order to reach the set temperature quickly.
	When the room has become fully cool, or when 1 hour has passed since turning on the air conditioner.		Air is blown only from the upper air outlet so that air does not come into direct contact with people and indoor temperature is equalized.
Heating	When the operation is activated or when air emitted is of low temperature.		Air is blown only from the upper air outlet so that air does not come into direct contact with people.
	At times other than the above situations.		Air is blown from the upper and lower air outlets so that warm air is spread throughout the whole room.
Dry	Whenever in DRY mode.		Air is blown only from the upper air outlet so that air does not come into direct contact with people.
Fan	Whenever in FAN mode.		—
Automatic	Operates in the actual operation mode of the air conditioner according to the descriptions in this table. (COOL or HEAT)		

- ◆ During dry operation, air is blown from upper air outlet, so that cold air does not come into direct contact with people.

When setting the airflow selection switch to .

- Regardless of the operating mode or situation, air is blown from the upper air outlet.
- Use this switch when you do not want air coming out of the lower air outlet (e.g., while sleeping).



2.2 COMFORT AIRFLOW Operation

Applicable Models

FTX09/12/15NMVJU
FTX18/24UVJU

Outline

The horizontal blades (louvers) are controlled not to blow the air directly at the people in the room.

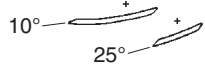
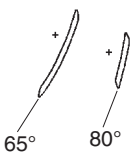
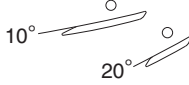
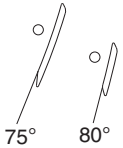
	Cooling	Heating
09/12 class	 0° R4003675	 65° R4003676
15 class	 10° 25° R4003682	 65° 80° R4003683
18/24 class	 10° 20° R4003684	 75° 80° R4003679

- The fan speed is controlled automatically within the following steps.

Cooling

L tap ~ MH tap (same as automatic)

Heating

L tap ~ M tap

- The latest command has the priority between POWERFUL and COMFORT AIRFLOW.

2.3 Fan Speed Control for Indoor Unit

Outline

Phase control and fan speed control contains 9 steps: LLL, LL, SL, L, ML, M, MH, H, and HH. The airflow rate can be automatically controlled depending on the difference between the room thermistor temperature and the target temperature.

Automatic Fan Speed Control

In automatic fan speed operation, the step SL is not available.

Step	Cooling	Heating
LLL	↕	↕
LL		
L		
ML		
M		
MH		
H		
HH (POWERFUL)		

↕ = The airflow rate is automatically controlled within this range when **FAN** setting button is set to automatic.

R4003512

■ Cooling

The following drawing explains the principle of fan speed control for cooling.

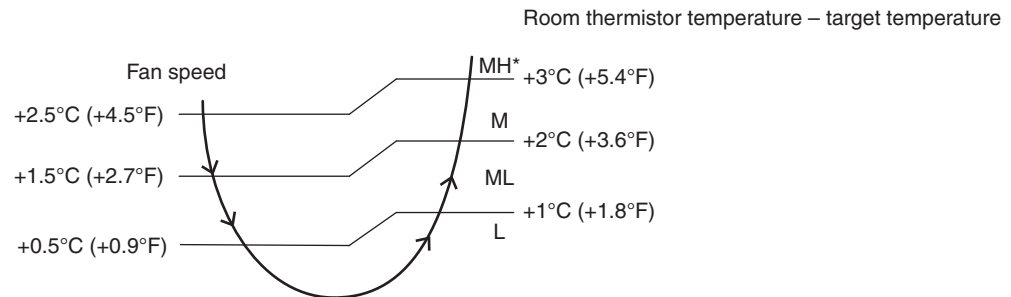

(R21654)

* The upper limit is at M tap in 30 minutes from the operation start.

■ Heating

In heating operation, the fan speed is regulated according to the indoor heat exchanger temperature and the difference between the room thermistor temperature and the target temperature.



Note(s)

The fan stops during defrost operation.

2.4 Program Dry Operation

Outline

Program dry operation removes humidity while preventing the room temperature from lowering. Since the microcomputer controls both the temperature and airflow rate, the temperature adjustment and **FAN** setting buttons are inoperable.

Details

The microcomputer automatically sets the temperature and airflow rate. The difference between the room thermistor temperature at start-up and the target temperature is divided into two zones. Then, the unit operates in an appropriate capacity for each zone to maintain the temperature and humidity at a comfortable level.

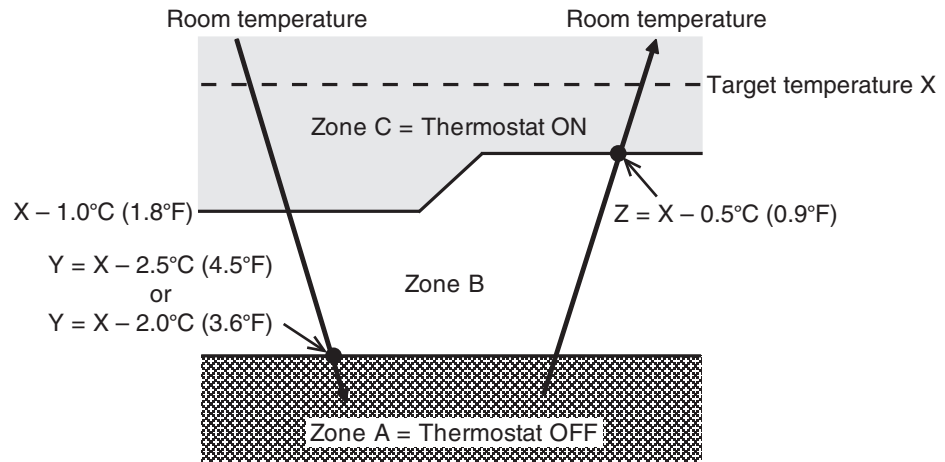

(R23000)

Room thermistor temperature at start-up	Target temperature X	Thermostat OFF point Y	Thermostat ON point Z ★
24°C or more (75.2°F or more)	Room thermistor temperature at start-up	X - 2.5°C (X - 4.5°F)	X - 0.5°C (X - 0.9°F)
18 ~ 23.5°C (64.4 ~ 74.3°F)		X - 2.0°C (X - 3.6°F)	X - 0.5°C (X - 0.9°F)
17.5°C or less (63.5°F or less)	18°C (64.4°F)	X - 2.0°C (X - 3.6°F)	X - 0.5°C = 17.5°C (X - 0.9°F = 63.5°F)

★ Thermostat turns on also when the room temperature is in the zone B for 10 minutes.

2.5 Automatic Cooling/Heating Changeover

Outline

When the automatic operation is selected with the remote controller, the microcomputer automatically determines the operation mode as cooling or heating according to the room temperature and the set temperature at start-up.

The unit automatically switches the operation mode to maintain the room temperature at the set temperature.

Details

Ts: set temperature (set by remote controller)

Tt: target temperature (determined by microcomputer)

Tr: room thermistor temperature (detected by room temperature thermistor)

C: correction value

- The set temperature (Ts) determines the target temperature (Tt).
(Ts = 18 ~ 30°C (64.4 ~ 86°F))
- The target temperature (Tt) is calculated as;
Tt = Ts + C
where C is the correction value.
C = 0°C (0°F)
- Thermostat ON/OFF point and operation mode switching point are as follows.
 - Heating → Cooling switching point:
Tr ≥ Tt + 3.0°C (+ 5.4°F)
 - Cooling → Heating switching point:
Tr < Tt - 3.0°C (- 5.4°F) (FTX09/12/15NMVJU)
Tr < Tt - 2.5°C (- 4.5°F) (FTX18/24UVJU)
 - Thermostat ON/OFF point is the same as the ON/OFF point of cooling or heating operation.
- During initial operation
Tr ≥ Ts : Cooling operation
Tr < Ts : Heating operation

FTX09/12/15NMVJU, FVXS Series

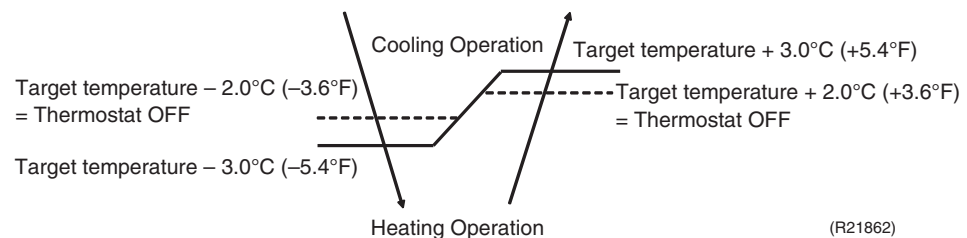

Ex: When the target temperature is 25°C (77°F)

Cooling → 23°C (73.4°F): Thermostat OFF → 22°C (71.6°F): Switch to heating

Heating → 27°C (80.6°F): Thermostat OFF → 28°C (82.4°F): Switch to cooling

FTX18/24UVJU

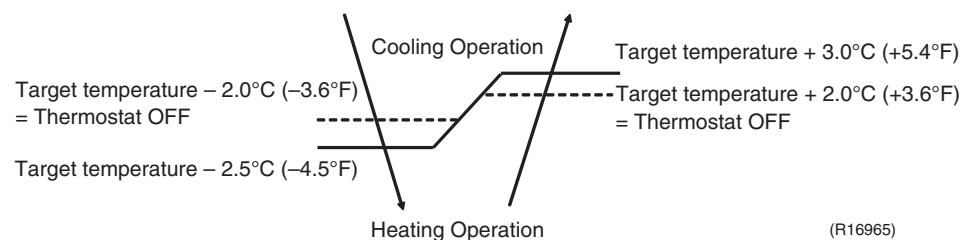

Ex: When the target temperature is 25°C (77°F)

Cooling → 23°C (73.4°F): Thermostat OFF → 22.5°C (72.5°F): Switch to heating

Heating → 27°C (80.6°F): Thermostat OFF → 28°C (82.4°F): Switch to cooling

2.6 Thermostat Control

Outline Thermostat control is based on the difference between the room thermistor temperature and the target temperature.

Details **Thermostat OFF Condition**
 ■ The temperature difference is in the zone A.

- Thermostat ON Conditions**
- The temperature difference returns to the zone C after being in the zone A.
 - The system resumes from defrost control in any zones except A.
 - The operation turns on in any zones except A.
 - The temperature difference remains in zone B for the determined monitoring time.

	Cooling	Dry	Heating
FTX09/12/15NMVJU	10 minutes	7.5 minutes	10 seconds
FTX18/24UVJU	10 minutes	10 minutes	10 seconds
FVXS series	10 minutes	10 minutes	10 seconds

Cooling/Dry

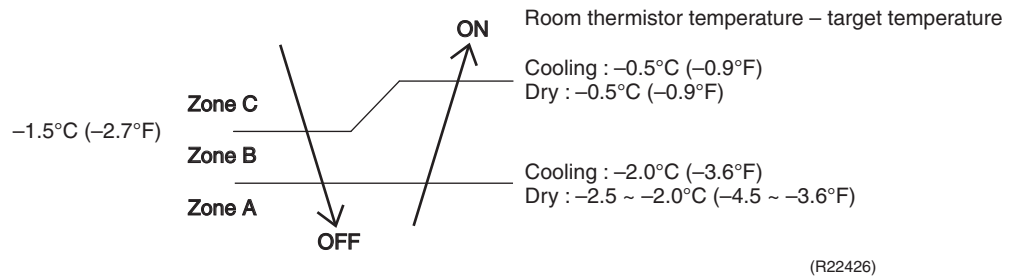

Heating FTX Series

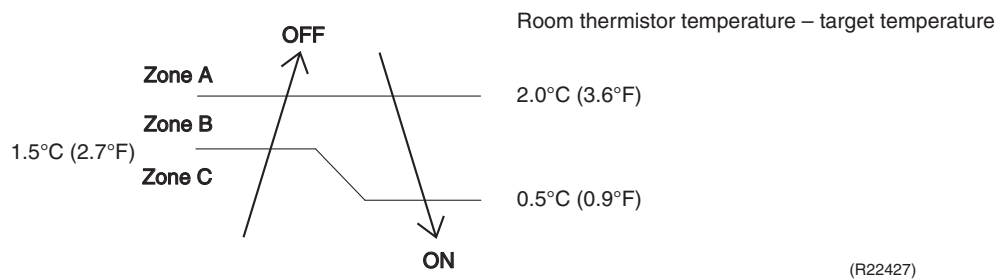

FVXS Series

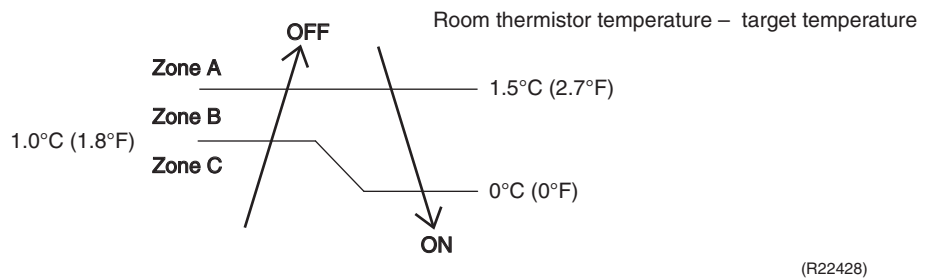

Reference

Refer to Temperature Control on page 44 for details.

2.7 NIGHT SET Mode

Outline

When the OFF TIMER is set, NIGHT SET mode is automatically activated. NIGHT SET mode keeps the airflow rate setting.

Details

NIGHT SET mode continues operation at the target temperature for the first one hour, then automatically raises the target temperature slightly in the case of cooling, or lowers the target temperature slightly in the case of heating. This prevents excessive cooling in summer and excessive heating in winter to ensure comfortable sleeping conditions, and also conserves electricity.

Cooling

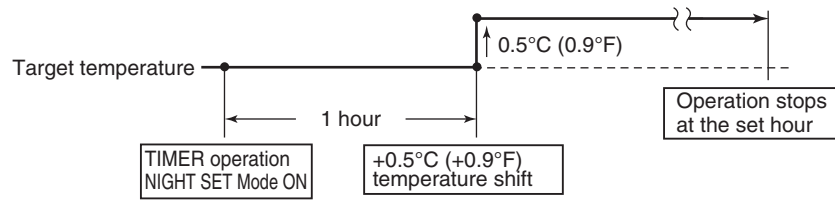

(R23917)

Heating

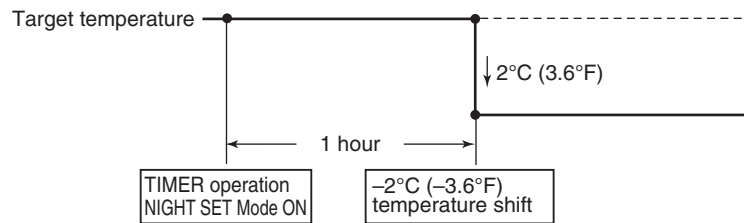

(R23918)

2.8 ECONO Operation

Outline

ECONO operation reduces the maximum operating current and the power consumption. This operation is particularly convenient for energy-saving. It is also a major bonus when breaker capacity does not allow the use of multiple electrical devices and air conditioners. It can be easily activated by pressing **ECONO** or **Econo/Quiet** button on the wireless remote controller.

Details

- When this function is activated, the maximum capacity also decreases.
- The remote controller can send the ECONO command when the unit is in cooling, heating, dry, or automatic operation. This function can only be set when the unit is running. To cancel the ECONO operation, press **ECONO** or **Econo/Quiet** button several times until the ECONO symbol on the remote controller disappears.
- This function and POWERFUL operation cannot be used at the same time. The latest command has the priority.

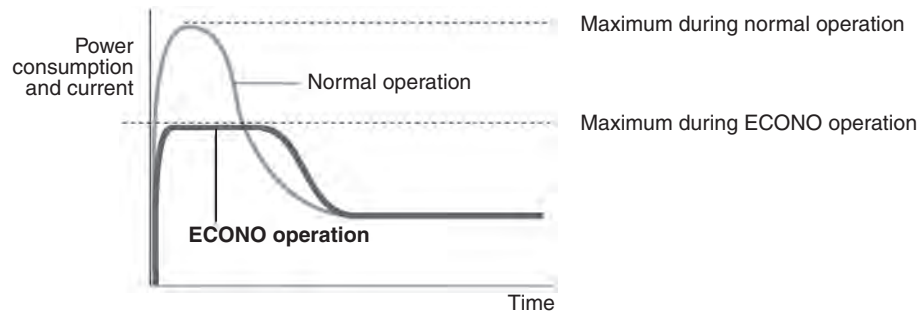

(R22012)

2.9 INTELLIGENT EYE Operation

Applicable Models

FTX18/24UVJU

Outline

The microcomputer detects the presence of humans in the room with a motion sensor and reduces the capacity when there is nobody in the room in order to save electricity.

Details

1. INTELLIGENT EYE detection method

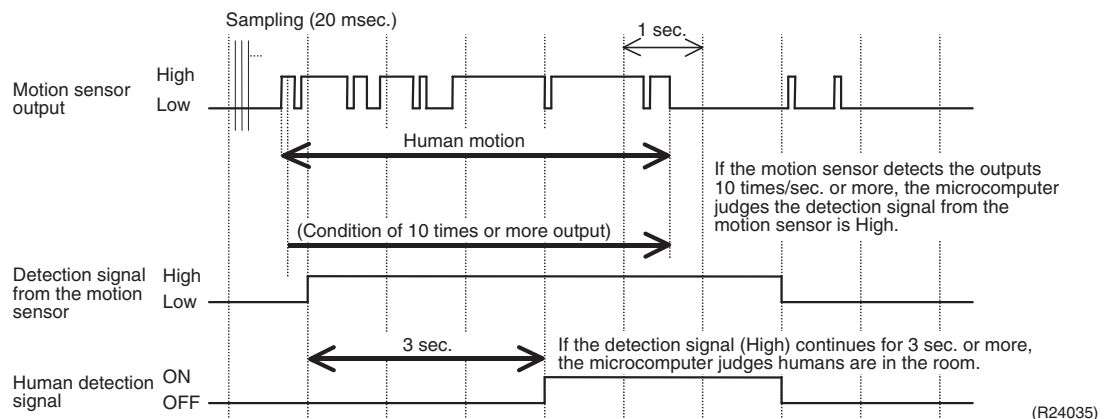

- The motion sensor detects human motion by receiving infrared rays and sends the pulse wave output.
- The microcomputer in the indoor unit carries out a sampling every 20 msec. If the motion sensor detects 10 times or more of the wave output in one second in total, and the High signal continues for 3 sec., the microcomputer judges humans are in the room as the human detection signal is ON.

2. Motions (in cooling)

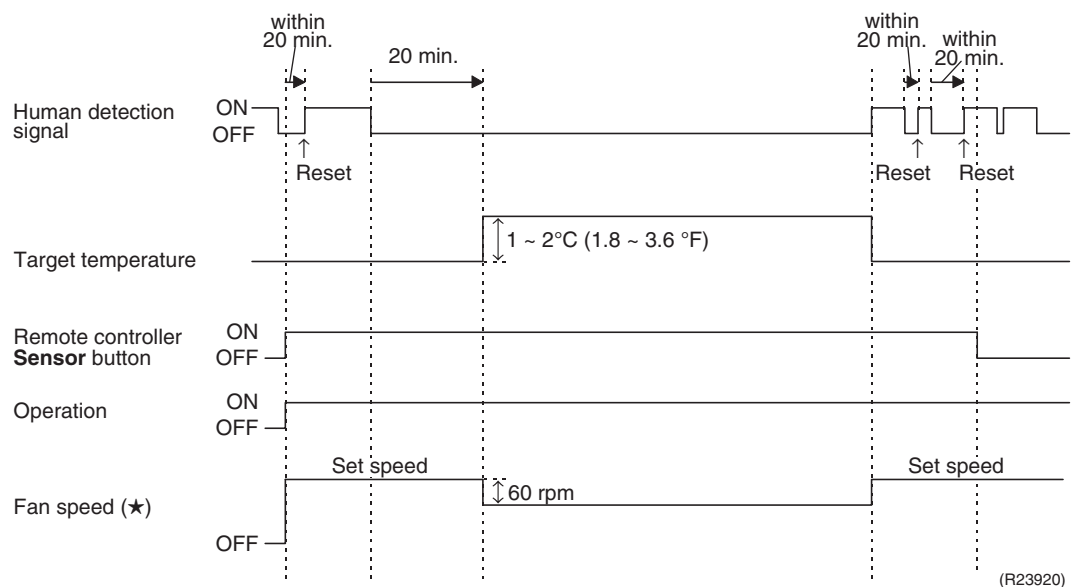

- ★ In FAN operation, the fan speed is reduced by 60 rpm when no one is in the area.
- When there is no signal from the motion sensor in 20 minutes, the microcomputer judges that nobody is in the room and operates the unit at a temperature shifted from the target temperature. (Cooling/Dry: 1 ~ 2°C (1.8 ~ 3.6°F) higher, Heating: 2°C (3.6°F) lower, Auto: according to the operation mode at that time)

i Note(s) For dry operation, the temperature cannot be set with a remote controller, but the target temperature is shifted internally.

2.10 POWERFUL Operation

Outline In order to exploit the cooling and heating capacity to full extent, the air conditioner can be operated by increasing the indoor fan rotating speed and the compressor frequency.

Details When **POWERFUL** button is pressed, the fan speed and target temperature are converted to the following states for 20 minutes.

Operation mode	Fan speed	Target temperature
COOL	H tap + A rpm	18°C (64.4°F)
DRY	Dry rotating speed + A rpm	Lowered by 2.5°C (4.5°F)
HEAT	H tap + A rpm	B
FAN	H tap + A rpm	—
AUTO	Same as cooling/heating in POWERFUL operation	The target temperature is kept unchanged.

A = FTX09/12/15NMVJU: 80 (rpm)
 FTX18/24UVJU: 50 (rpm)
 FVXS series: 30 ~ 40 (rpm)

B = FTX09/12/15NMVJU: 31°C (87.8°F)
 FTX18/24UVJU: 31.5°C (88.7°F)
 FVXS series: 32°C (89.6°F)

Ex: POWERFUL operation in cooling

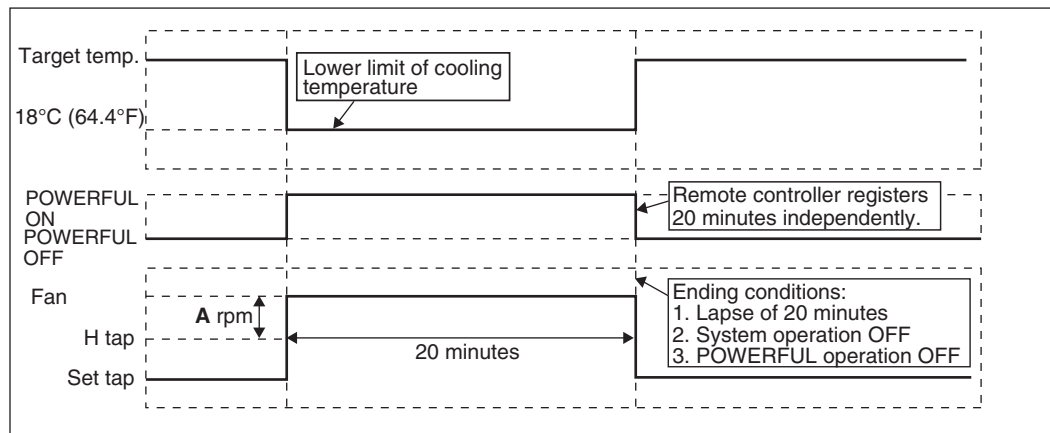

(R24589)

i Note(s) ■ POWERFUL operation cannot be used together with ECONO, COMFORT AIRFLOW, or OUTDOOR UNIT QUIET operation.

2.11 Clock Setting

ARC466 Series

The clock can be set by taking the following steps:

1. Press **Clock** button.
→ 0:00 is displayed, then **MON** and ☰ blink.
2. Press **Select ▲** or **Select ▼** button to set the clock to the current day of the week.
3. Press **Clock** button.
→ ☰ blinks.
4. Press **Select ▲** or **Select ▼** button to set the clock to the present time.
Holding down **Select ▲** or **Select ▼** button rapidly increases or decreases the time display.
5. Press **Clock** button to set the clock. Point the remote controller at the indoor unit when pressing the button.
→ ☰ blinks and clock setting is completed.

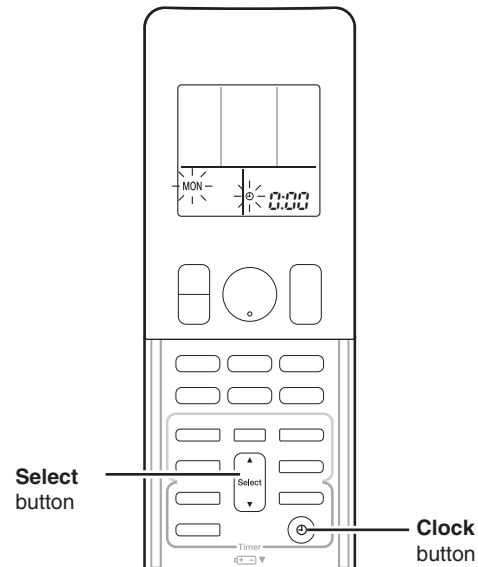

(R19926)

2.12 WEEKLY TIMER Operation

Applicable Models

FTX18/24UVJU
FVXS09/12/15NVJU

Outline

Up to 4 timer settings can be saved for each day of the week (up to 28 settings in total).
The 3 items: ON/OFF, temperature, and time can be set.

Details

★ The illustrations are for FVXS series as representative.

Setting example of the WEEKLY TIMER

The same timer settings are used from Monday through Friday, while different timer settings are used for the weekend.

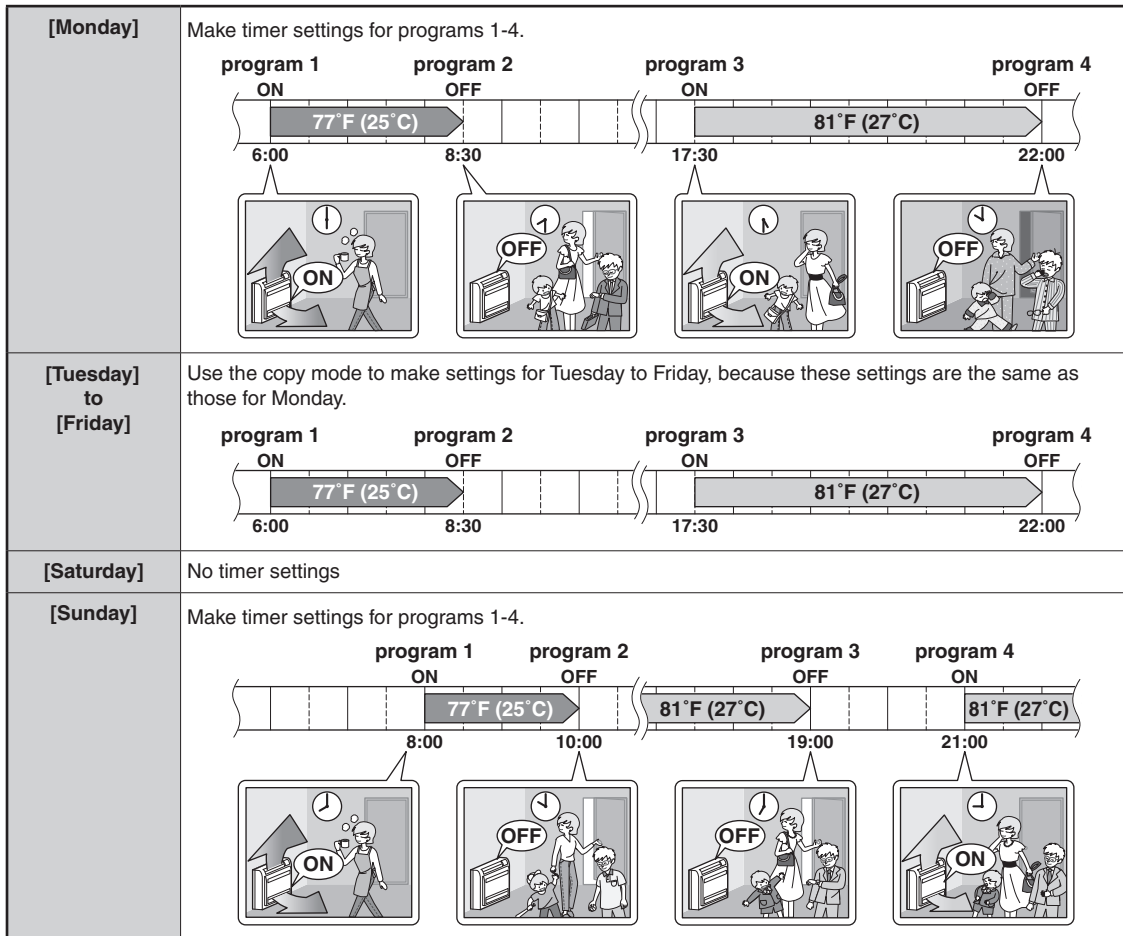

- Up to 4 reservations per day and 28 reservations per week can be set using the WEEKLY TIMER. The effective use of the copy mode simplifies timer programming.
- The use of ON-ON-ON-ON settings, for example, makes it possible to schedule operating mode and set temperature changes. Furthermore, by using OFF-OFF-OFF-OFF settings, only the turn off time of each day can be set. This will turn off the air conditioner automatically if you forget to turn it off.

R4003657

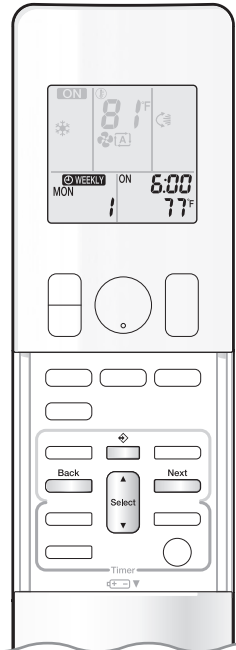

To use WEEKLY TIMER operation

Setting mode

- Make sure the day of the week and time are set.
If not, set the day of the week and time.

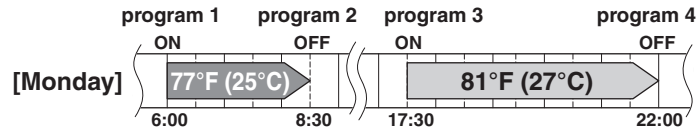

Setting Displays

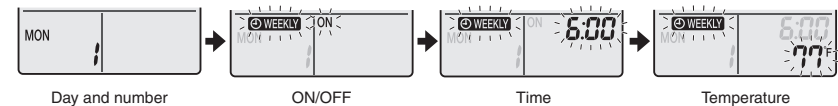

1. Press .

- The day of the week and the reservation number of the current day will be displayed.
- 1 to 4 settings can be made per day.

2. Press to select the desired day of the week and reservation number.

- Pressing  changes the reservation number and the day of the week.

3. Press .

- The day of the week and reservation number will be set.
- “ WEEKLY ” and “ON” blink.

4. Press to select the desired mode.

- Pressing  changes the “ON” or “OFF” setting in sequence.



- In case the reservation has already been set, selecting “blank” deletes the reservation.
- Proceed to **STEP 9** if “blank” is selected.
- To return to the day of the week and reservation number setting, press .

5. Press .

- The ON/OFF TIMER mode will be set.
- “ WEEKLY ” and the time blink.

R4003658

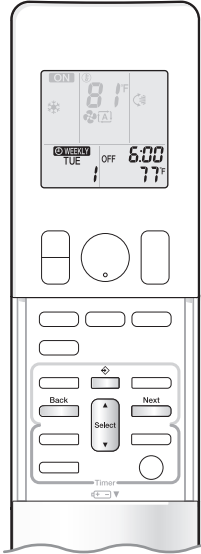

6. Press  to select the desired time.

- The time can be set between 0:00 and 23:50 in 10-minute intervals.
- To return to the ON/OFF TIMER mode setting, press .
- Proceed to **STEP 9** when setting the OFF TIMER.

7. Press .

- The time will be set.
- “ WEEKLY” and the temperature blink.

8. Press  to select the desired temperature.

- The temperature can be set between 50°F (10°C) and 90°F (32°C).
COOL or AUTO: The unit operates at 64°F (18°C) even if it is set at 50°F (10°C) to 63°F (17°C).
HEAT or AUTO : The unit operates at 86°F (30°C) even if it is set at 87°F (31°C) to 90°F (32°C).
- To return to the time setting, press .
- The set temperature is only displayed when the mode setting is on.

9. Press .

- The temperature will be set and go to the next reservation setting.
- The temperature is set while in ON TIMER operation, and the time is set while in OFF TIMER operation.
- The next reservation screen will appear.
- To continue further settings, repeat the procedure from **STEP 4**.

10. Press  to complete the setting.

- Be sure to direct the remote controller toward the indoor unit and check for a receiving tone and blinking of the OPERATION lamp.
- “ WEEKLY” is displayed on the LCD and WEEKLY TIMER operation is activated.
- The TIMER lamp lights orange.

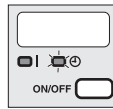



Display

- A reservation made once can be easily copied and the same settings used for another day of the week. Refer to **Copy mode**.

NOTE

Notes on WEEKLY TIMER operation

- Do not forget to set the clock on the remote controller first.
- The day of the week, ON/OFF TIMER mode, time and set temperature (only for ON TIMER mode) can be set with the WEEKLY TIMER. Other settings for the ON TIMER are based on the settings just before the operation.
- WEEKLY TIMER and ON/OFF TIMER operation cannot be used at the same time. The ON/OFF TIMER operation has priority if it is set while WEEKLY TIMER is still active. The WEEKLY TIMER will enter the standby state, and “ WEEKLY” will disappear from the LCD. When the ON/OFF TIMER is up, the WEEKLY TIMER will automatically become active.
- Only the time and set temperature with the WEEKLY TIMER are sent with the . Set the WEEKLY TIMER only after setting the operation mode, the airflow rate and the airflow direction ahead of time.
- Turning off the circuit breaker, power failure, and other similar events will render operation of the indoor unit's internal clock inaccurate. Reset the clock.
-  can be used only for the time and temperature settings. It cannot be used to go back to the reservation number.

R4003659

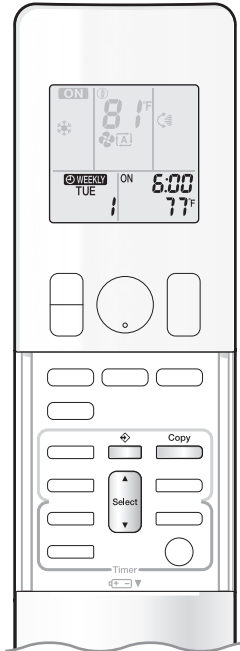

Copy mode

- A reservation made once can be copied to another day of the week. The whole reservation of the selected day of the week will be copied.

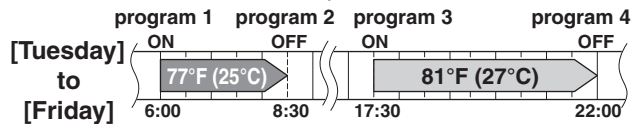
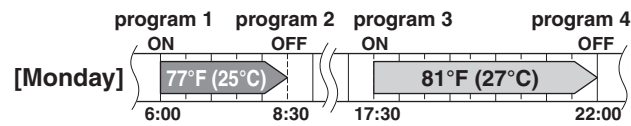

Setting Displays

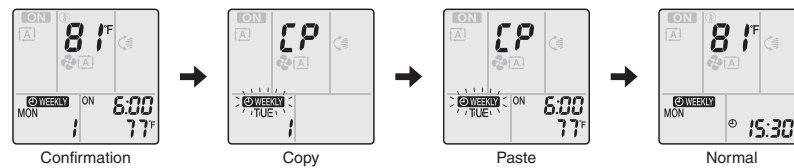

1. Press .

2. Press to confirm the day of the week to be copied.

3. Press .

- The whole reservation of the selected day of the week will be copied.

4. Press to select the destination day of the week.

5. Press .

- The reservation will be copied to the selected day of the week. The whole reservation of the selected day of the week will be copied.
- To continue copying the settings to other days of the week, repeat **STEP 4** and **STEP 5**.

6. Press to complete the setting.

- “ WEEKLY” is displayed on the LCD and WEEKLY TIMER operation is activated.
- The TIMER lamp periodically lights orange.

NOTE

Note on COPY MODE

- The entire reservation of the source day of the week is copied in the copy mode.
- In the case of making a reservation change for any day of the week individually after copying the content of weekly reservations, press and change the settings in the steps of **Setting mode**.

R4003660

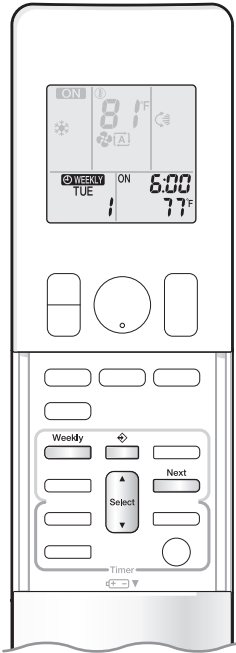

Confirming a reservation

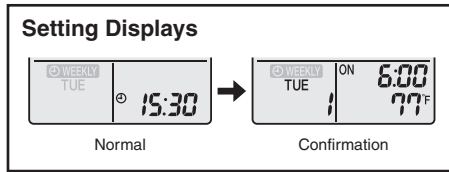

- The reservation can be confirmed.



1. Press .

- The day of the week and the reservation number of the current day will be displayed.

2. Press to select the day of the week and the reservation number to be confirmed.

- Pressing  displays the reservation details.
- To change the confirmed reserved settings, select the reservation number and press . The mode is switched to setting mode. Proceed to **Setting mode STEP 4**.

3. Press to exit the confirmation mode.

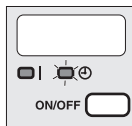

- “ WEEKLY” is displayed on the LCD and WEEKLY TIMER operation is activated.
- The TIMER lamp lights orange.



Display

To deactivate WEEKLY TIMER operation

Press while “ WEEKLY” is displayed on the LCD.

- “ WEEKLY” disappears from the LCD.
- The TIMER lamp goes off.
- To reactivate the WEEKLY TIMER operation, press  again.
- If a reservation deactivated with  is activated once again, the last reservation mode will be used.

NOTE

- If not all the reservation settings are reflected, deactivate the WEEKLY TIMER operation once. Then press  again to reactivate the WEEKLY TIMER operation.

R4003661

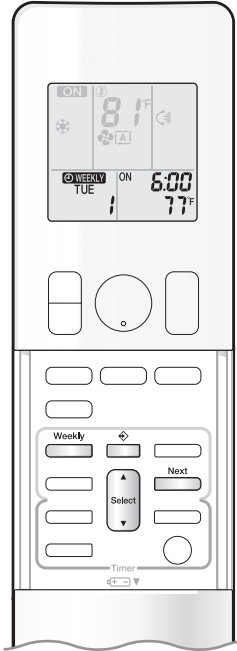

To delete reservations

An individual reservation

1. Press .

- The day of the week and the reservation number will be displayed.

2. Press to select the day of the week and the reservation number to be deleted.

3. Press .

- “ WEEKLY” and “ON” or “OFF” blink.

4. Press until no icon is displayed.

- Pressing  changes the ON/OFF TIMER mode in sequence.
- Selecting “blank” will cancel any reservation you may have.



5. Press .

- The selected reservation will be deleted.

6. Press .

- If there are still other reservations, WEEKLY TIMER operation will be activated.

Reservations for each day of the week

- This function can be used for deleting reservations for each day of the week.
- It can be used while confirming or setting reservations.

1. Press .

- The day of the week and the reservation number will be displayed.

2. Press to select the day of the week to be deleted.

3. Hold for about 5 seconds.

- The reservation of the selected day of the week will be deleted.

4. Press .

- If there are still other reservations, WEEKLY TIMER operation will be activated.

All reservations

Hold for about 5 seconds with the normal display.

- Be sure to direct the remote controller toward the indoor unit and check for a receiving tone.
- This operation cannot be used for the WEEKLY TIMER setting display.
- All reservations will be deleted.

R4003662

2.13 Other Functions

2.13.1 Hot-Start Function

In order to prevent the cold air blast that normally occurs when heating operation is started, the temperature of the indoor heat exchanger is detected, and the airflow is either stopped or significantly weakened resulting in comfortable heating.



Note(s) The cold air blast is prevented using similar control when defrost control starts or when the thermostat is turned ON.

2.13.2 Signal Receiving Sign

When the indoor unit receives a signal from the remote controller, the unit emits a signal receiving sound.

2.13.3 Indoor Unit ON/OFF Switch

ON/OFF switch is provided on the display of the unit.

- Press ON/OFF switch once to start operation. Press once again to stop it.
- ON/OFF switch is useful when the remote controller is missing or the battery has run out.

Operation mode	Temperature setting	Airflow rate
AUTO	25°C (77°F)	Automatic

FTX09/12/15NMVJU

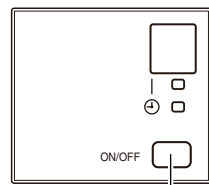

ON/OFF switch

(R21052)

FTX18/24UVJU

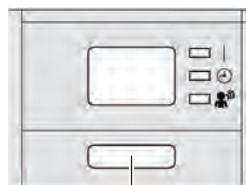

ON/OFF switch

(R13555)

FVXS Series

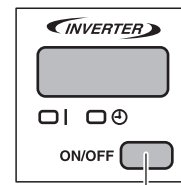

ON/OFF switch

(R23001)

Forced Cooling Operation

Forced cooling operation can be started by pressing ON/OFF switch for 5 to 9 seconds while the unit is not operating.

Refer to page 199 for details.



Note(s) Forced cooling operation is not started if ON/OFF switch is pressed for 10 seconds or more.

2.13.4 Auto-restart Function

If a power failure (even a momentary one) occurs during the operation, the system restarts automatically in the same conditions as before when the power supply is restored to the conditions prior to the power failure.



Note It takes 3 minutes to restart the operation because 3-minute standby function is activated.

3. Functions for FDMQ Series

3.1 Fan Speed Control for Indoor Unit

■ With Wired Remote Controller (BRC1E73)

To change the fan speed, press **Fan Speed** button and select the fan speed from Low/Medium/High/Auto.

- ◆ Auto cannot be selected if the indoor unit does not have Auto Fan speed function.
- ◆ The system may change the fan speed automatically for equipment protection purposes.
- ◆ The system may turn off the fan when the room temperature is satisfied.
- ◆ It is normal for a delay to occur when changing the fan speed.
- ◆ If the Auto is selected for the fan speed, the fan speed varies automatically based on the difference between set temperature and room temperature.

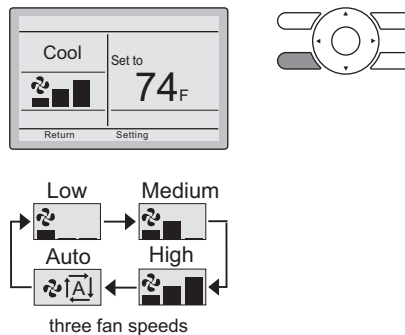

■ With Wireless Remote Controller (BRC082A43)

Press **FAN SPEED CONTROL** button.

High, Medium or Low fan speed can be selected.

The microchip may sometimes control the fan speed in order to protect the unit.

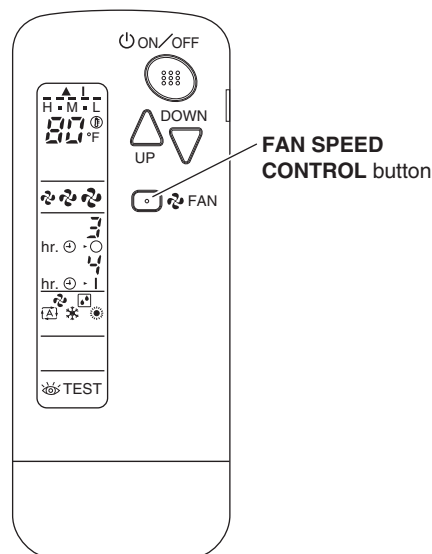

R4003380

R4003666

3.2 Program Dry Operation

Outline

Program dry operation removes humidity while preventing the room temperature from lowering. Since the microcomputer controls both the temperature and airflow rate, the temperature adjustment and **FAN** setting buttons are inoperable.

Details

The microcomputer automatically sets the temperature and airflow rate. The difference between the room thermistor temperature at start-up and the target temperature is divided into two zones. Then, the unit operates in an appropriate capacity for each zone to maintain the temperature and humidity at a comfortable level.

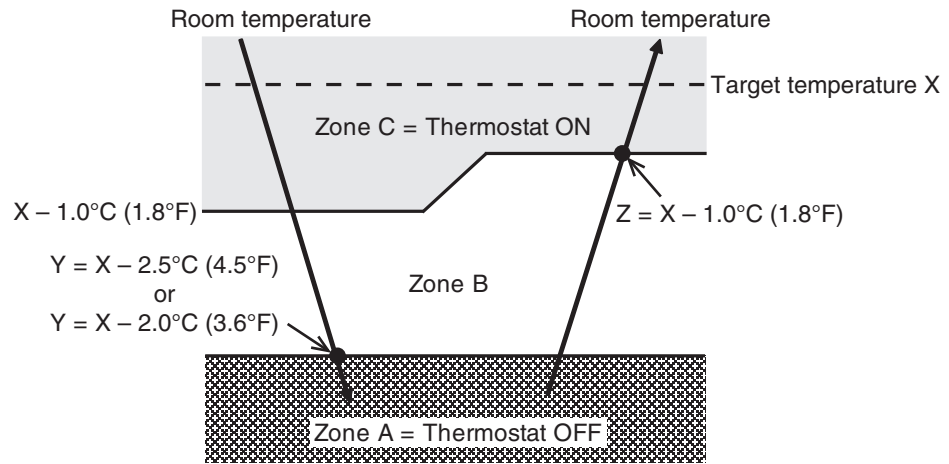

(R23000)

Room thermistor temperature at start-up	Target temperature X	Thermostat OFF point Y	Thermostat ON point Z
24.5°C or more (76.1°F or more)	Room thermistor temperature at start-up	X - 2.5°C (X - 4.5°F)	X - 1.0°C (X - 1.8°F)
16.5 ~ 24°C (61.7 ~ 75.2°F)		X - 2.0°C (X - 3.6°F)	X - 1.0°C (X - 1.8°F)
16°C or less (60.8°F or less)	16°C (60.8°F)	X - 2.0°C (X - 3.6°F)	X - 1.0°C = 15°C (X - 1.8°F = 59°F)

3.3 Clock and Calendar Setting (With BRC1E73)

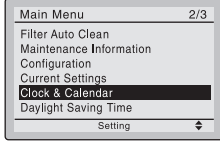
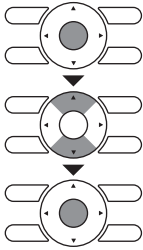
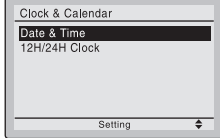
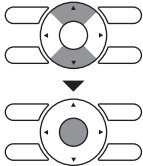
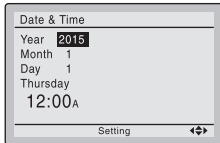
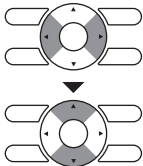
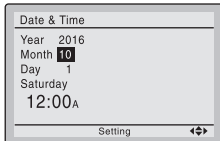
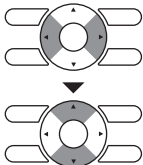
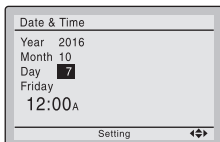
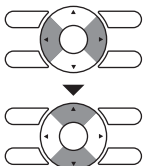
-
- 1**
- 
- Press **Menu/OK** button to display the main menu screen.
 - Press **▼▲** buttons to select **Clock & Calendar** on the main menu screen.
Press **Menu/OK** button to display the clock & calendar screen.
- 
-
- 2**
- 
- Press **▼▲** buttons to select **Date & Time** on the clock & calendar screen.
Press **Menu/OK** button to display the date & time screen.
- 
-
- 3**
- 
- Select **Year** with **◀▶** buttons.
Change the year with **▼▲** buttons.
Holding down the button causes the number to change continuously.
- 
-
- 4**
- 
- Select **Month** with **◀▶** buttons.
Change the month with **▼▲** buttons.
Holding down the button causes the number to change continuously.
- 
-
- 5**
- 
- Select **Day** with **◀▶** buttons.
Change the day with **▼▲** buttons.
Holding down the button causes the number to change continuously.
Days of the week change automatically.
- 
-

(R24368)

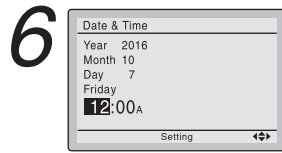

- Select **Hour** with ◀▶ buttons. Change the hour with ▼▲ buttons. Holding down the button causes the number to change continuously.

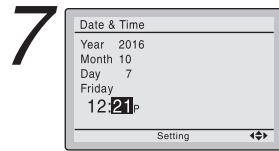
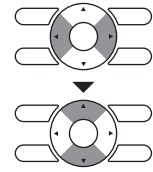

- Select **Minute** with ◀▶ buttons. Change the minute with ▼▲ buttons. Holding down the button causes the number to change continuously.
- Press **Menu/OK** button. The confirmation screen will appear.

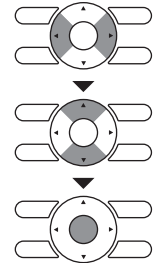

Note: —
The date can be set between January 1, 2015 and December 31, 2099.

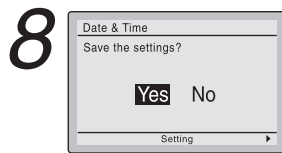

- Press ◀▶ button to select **Yes** on the confirmation screen. Press **Menu/OK** button to confirm the clock and return to the basic screen.

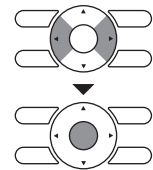

* When setting the schedule, the display returns to the settings screen.

(R24072)

3.4 Schedule Timer Operation (With BRC1E73)

Outline

Day settings are selected from 4 patterns:

- 7 Days
- Weekday/Sat/Sun
- Weekday/Weekend
- Everyday

Up to 5 actions can be set for each day.

Details

Set the startup time and operation stop time.

ON: Startup time, cooling and heating temperature setpoints can be configured.

OFF: Operation stop time, cooling and heating setback temperature setpoints can be configured.

(--: Indicates that the setback function is disabled for this time period.)

_: Indicates that the temperature setpoint and setback temperature setpoint for this time period is not specified. The last active setpoint will be utilized.

■ Setting the schedule

1

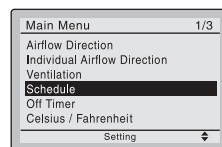

- Press **Menu/OK** button to display the main menu screen.
- Press **▼▲** buttons to select **Schedule**. Press **Menu/OK** button to display the schedule screen.

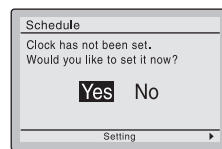

- Before setting the schedule, the clock must be set.
- If the clock has not been set, a screen like the one on the left will appear. Press **◀▶** buttons to select **Yes** and press **Menu/OK** button.

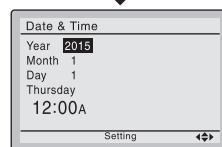

- The date & time screen will appear.
- Set the current year, month, day, and time.

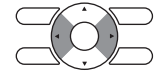

2

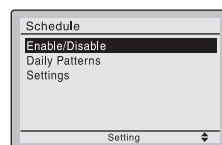

- Press **▼▲** buttons to select the desired function on the schedule screen and press **Menu/OK** button.



(R24369)

■ Daily Patterns

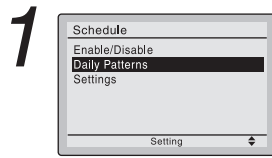

- The schedule screen will appear.
- Press ▼▲ buttons to select **Daily Patterns** on the schedule screen. The daily patterns screen will appear when **Menu/OK** button is pressed.

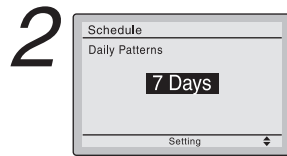
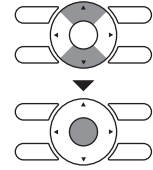

- Press ▼▲ buttons to select **7 Days**, **Weekday/Sat/Sun**, **Weekday/Weekend** or **Everyday** on the daily patterns screen. The confirmation screen will appear when **Menu/OK** button is pressed.

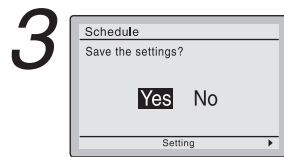
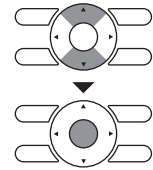

- Press ◀▶ buttons to select **Yes** on the confirmation screen. Pressing **Menu/OK** button enters the daily patterns in the schedule and takes you back to the main menu screen.

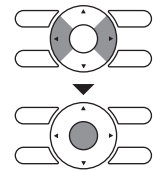

(R24074)

■ Settings

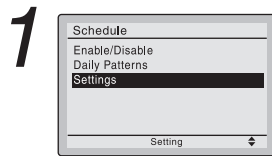

- The schedule screen will appear.
- Press ▼▲ buttons to select **Settings** on the schedule screen. The settings screen will appear when **Menu/OK** button is pressed.

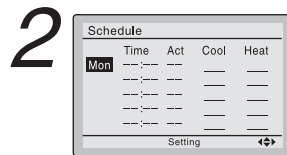
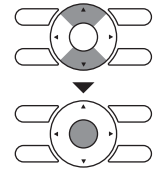

- Press ▼▲ buttons to select the day to be set.
- * It cannot be selected in the case of **EVDY**.

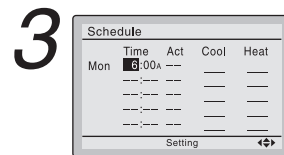

- Input the time for the selected day.
- Press ◀▶ buttons to move the highlighted item and press ▼▲ buttons to input the desired operation start time. Each press of ▼▲ buttons moves the numbers by 1 hour or 1 minute.

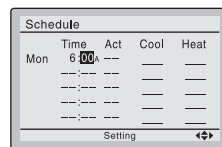
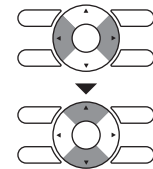

R4003456

■ Enabling or disabling the schedule

1

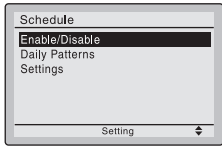

- Display the schedule screen.
- Press ▼▲ buttons to select **Enable / Disable** on the schedule screen.

Press **Menu/OK** button to display the enable/disable screen.

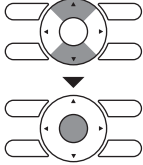

2

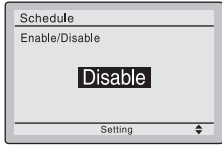

- Press ▼▲ buttons to select **Enable** or **Disable** on the enable/disable screen.

Press **Menu/OK** button after selecting the item. The confirmation screen is displayed.

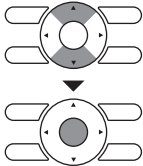

3

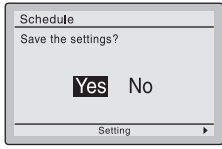

- Press ◀▶ buttons to select **Yes** on the confirmation screen.

Pressing **Menu/OK** button confirms the enable/disable setting for the schedule and takes you back to the basic screen.

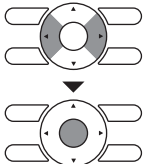

R4003458

3.5 Drain Pump Control

Normal Operation

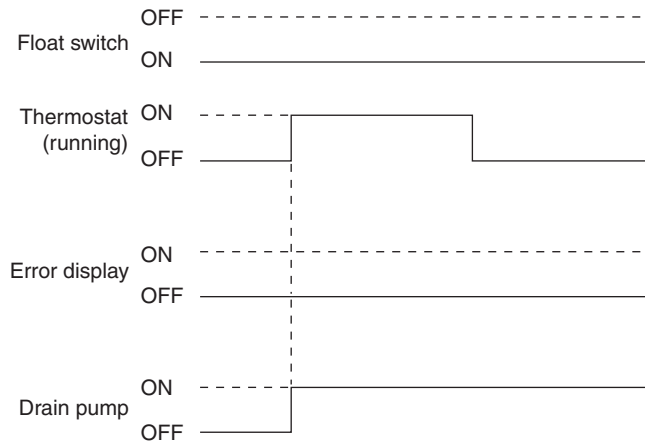

(R24037)

- The float switch is ON in normal operation.
- When cooling operation starts (thermostat ON), the drain pump turns ON simultaneously.
- After the thermostat turns OFF, the drain pump continues to operate.

If Float Switch is OFF with Thermostat ON in Cooling Operation

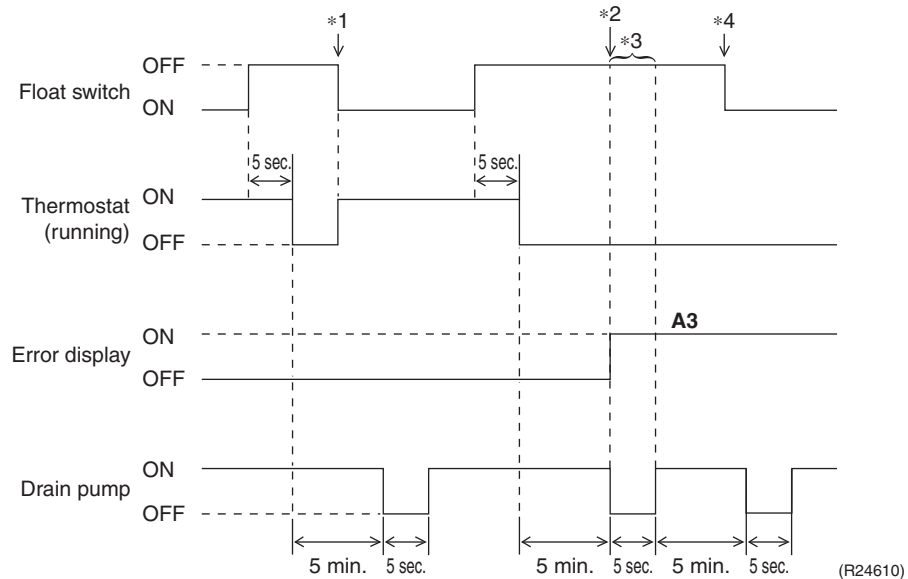

- When the float switch stays OFF for 5 sec., the thermostat turns OFF.
- After the thermostat turns OFF, the drain pump continues to operate for another 5 minutes.
- *1. If the float switch turns ON again during the residual operation of the drain pump, cooling operation also turns on again (thermostat ON).
- *2. If the float switch remains OFF even after the residual operation of the drain pump has ended, the error code **A3** is determined.
- *3. The drain pump turns OFF once residual operation has ended, then turns ON again after 5 seconds.
- *4. After **A3** is determined and the unit comes to an abnormal stop, the thermostat will remain OFF even if the float switch turns ON again.

If Float Switch is OFF with Thermostat OFF in Cooling Operation

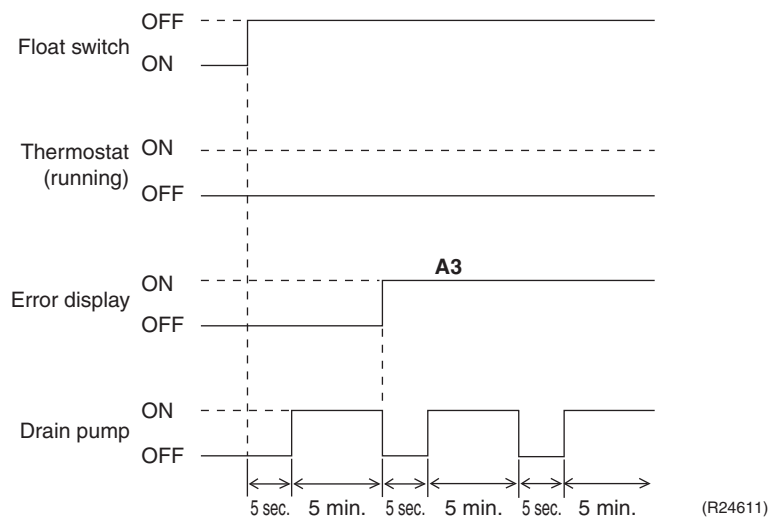

- When the float switch stays OFF for 5 sec., the drain pump turns ON.
- If the float switch remains OFF even after the residual operation of the drain pump has ended, the error code **A3** is determined.
- The drain pump turns OFF once residual operation has ended, then turns ON again after 5 seconds.

3.7 Other Functions

3.7.1 Signal Receiving Sign

When the indoor unit receives a signal from the remote controller, the unit emits a signal receiving sound.

3.7.2 Auto-restart Function

If a power failure (even a momentary one) occurs during the operation, the system restarts automatically in the same conditions as before when the power supply is restored to the conditions prior to the power failure.



Note

It takes 3 minutes to restart the operation because 3-minute standby function is activated.

3.7.3 Emergency Operation Switch (With BRC082A43)

Outline

When the wireless remote controller does not work due to battery failure or the absence thereof, use the emergency operation switch.

Details

Start

Press emergency operation switch.

- The indoor unit runs in the previous operation mode.
- The system operates with the previously set airflow direction.

Stop

Press emergency operation switch again.

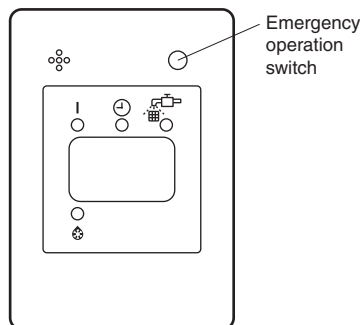

(R24925)

4. Thermistor Functions

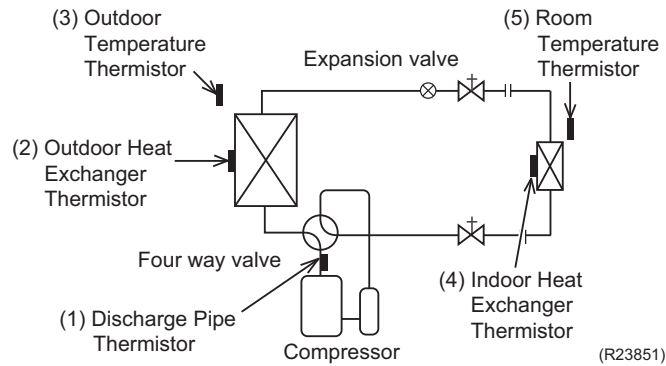

(1) Discharge Pipe Thermistor

- The discharge pipe thermistor is used for controlling discharge pipe temperature. If the discharge pipe temperature (used in place of the inner temperature of the compressor) rises abnormally, the operating frequency becomes lower or the operation halts.

- The discharge pipe thermistor is used for detecting disconnection of the discharge pipe thermistor.

(2) Outdoor Heat Exchanger Thermistor

- The outdoor heat exchanger thermistor is used for controlling the target discharge pipe temperature. The system sets the target discharge pipe temperature according to the outdoor and indoor heat exchanger temperature, and controls the electronic expansion valve opening so that the target discharge pipe temperature can be obtained.

- In cooling operation, the outdoor heat exchanger thermistor is used for detecting the disconnection of the discharge pipe thermistor. When the discharge pipe temperature drops below the outdoor heat exchanger temperature by more than a certain value, the discharge pipe thermistor is judged as disconnected.

- In cooling operation, the outdoor heat exchanger thermistor is used for high pressure protection.

(3) Outdoor Temperature Thermistor

- The outdoor temperature thermistor detects the outdoor air temperature and is used for refrigerant shortage detection, input current control, outdoor fan control, liquid compression protection function, and so on.

(4) Indoor Heat Exchanger Thermistor

- The indoor heat exchanger thermistor is used for controlling the target discharge pipe temperature. The system sets the target discharge pipe temperature according to the outdoor and indoor heat exchanger temperature, and controls the electronic expansion valve opening so that the target discharge pipe temperature can be obtained.

- In cooling operation, the indoor heat exchanger thermistor is used for freeze-up protection control. If the indoor heat exchanger temperature drops abnormally, the operating frequency becomes lower or the operation halts.

- In heating operation, the indoor heat exchanger thermistor is used for detecting the disconnection of the discharge pipe thermistor. When the discharge pipe temperature drops below the indoor heat exchanger temperature by more than a certain value, the discharge pipe thermistor is judged as disconnected.

(5) Room Temperature Thermistor

- The room temperature thermistor detects the room air temperature and is used for controlling the room air temperature.

5. Control Specification

5.1 Mode Hierarchy

Outline

The air conditioner control has normal operation mode, forced operation mode, and power transistor test mode for installation and servicing.

Details

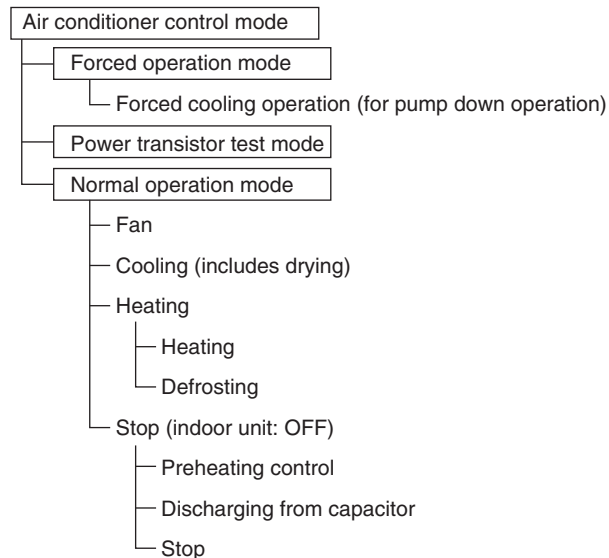

(R22375)

- Unless specified otherwise, dry operation command is regarded as cooling operation.

5.2 Frequency Control

Outline

The compressor frequency is determined according to the difference between the room thermistor temperature and the target temperature.

When the shift of the frequency is less than zero ($\Delta F < 0$) by PI control, the target frequency is used as the command frequency.

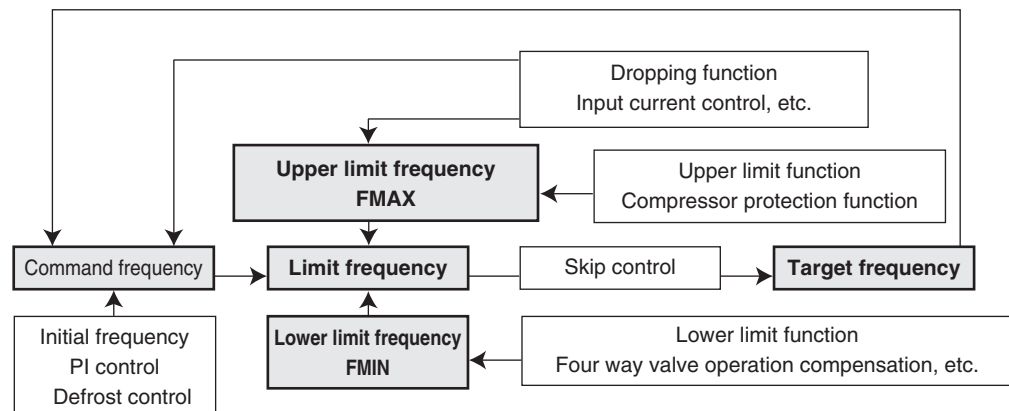

(R18023)

Details

1. Determine command frequency

Command frequency is determined in the following order of priority.

- (1) Limiting defrost control time
- (2) Forced cooling

(3) Indoor frequency command

2. Determine upper limit frequency

The minimum value is set as an upper limit frequency among the frequency upper limits of the following functions:

Compressor protection, input current, discharge pipe temperature, heating peak-cut, freeze-up protection, defrost control.

3. Determine lower limit frequency

The maximum value is set as a lower limit frequency among the frequency lower limits of the following functions:

Four way valve operation compensation, draft prevention, pressure difference upkeep.

4. Determine prohibited frequency

There is a certain prohibited frequency such as a power supply frequency.

Initial Frequency

When starting the compressor, the frequency is initialized according to the ΔD value of the indoor unit.

ΔD signal: Indoor frequency command

The difference between the room thermistor temperature and the target temperature is taken as the ΔD value and is used for ΔD signal of frequency command.

Temperature difference	ΔD signal	Temperature difference	ΔD signal	Temperature difference	ΔD signal	Temperature difference	ΔD signal
-2.0°C (-3.6°F)	*OFF	0°C (0°F)	4	2.0°C (3.6°F)	8	4.0°C (7.2°F)	12
-1.5°C (-2.7°F)	1	0.5°C (0.9°F)	5	2.5°C (4.5°F)	9	4.5°C (8.1°F)	13
-1.0°C (-1.8°F)	2	1.0°C (1.8°F)	6	3.0°C (5.4°F)	10	5.0°C (9.0°F)	14
-0.5°C (-0.9°F)	3	1.5°C (2.7°F)	7	3.5°C (6.3°F)	11	5.5°C (9.9°F)	15

* OFF = Thermostat OFF

PI Control

1. P control

The ΔD value is calculated in each sampling time (20 seconds), and the frequency is adjusted according to its difference from the frequency previously calculated.

2. I control

If the operating frequency does not change for more than a certain fixed time, the frequency is adjusted according to the ΔD value.

When ΔD value is low, the frequency is lowered.

When ΔD value is high, the frequency is increased.

3. Frequency control when other controls are functioning

- When frequency is dropping:
Frequency control is carried out only when the frequency drops.
- For limiting lower limit:
Frequency control is carried out only when the frequency rises.

4. Upper and lower limit of frequency by PI control

The frequency upper and lower limits are set according to the command of the indoor unit.

When the indoor or outdoor unit quiet operation command comes from the indoor unit, the upper limit frequency is lower than the usual setting.

5.3 Controls at Mode Changing/Start-up

5.3.1 Preheating Control

Outline

The inverter operation in open phase starts with the conditions of the outdoor temperature, the discharge pipe temperature, the radiation fin temperature and the preheating command from the indoor unit.

Details

09/15 class

Outdoor temperature $\geq -2.5^{\circ}\text{C}$ (27.5°F) Control A (preheating for normal state)

Outdoor temperature $< -2.5^{\circ}\text{C}$ (27.5°F) Control B (preheating of increased capacity)

Control A

- ON condition
 - Discharge pipe temperature $< 0^{\circ}\text{C}$ (32.0°F)
 - Radiation fin temperature $< 85^{\circ}\text{C}$ (185°F)
- OFF condition
 - Discharge pipe temperature $> 2^{\circ}\text{C}$ (35.6°F)
 - Radiation fin temperature $\geq 90^{\circ}\text{C}$ (194°F)

Control B

- ON condition
 - Discharge pipe temperature $< 10^{\circ}\text{C}$ (50.0°F)
 - Radiation fin temperature $< 85^{\circ}\text{C}$ (185°F)
- OFF condition
 - Discharge pipe temperature $> 12^{\circ}\text{C}$ (53.6°F)
 - Radiation fin temperature $\geq 90^{\circ}\text{C}$ (194°F)

12/18/24 class

- ON condition
 - Discharge pipe temperature $< \text{Outdoor temperature} \times \mathbf{A} + \mathbf{B}$
 - Outdoor temperature $< \mathbf{C}$
 - Radiation fin temperature $< \mathbf{D}$
- OFF condition
 - Discharge pipe temperature $> \text{Outdoor temperature} \times \mathbf{A} + \mathbf{E}$
 - Outdoor temperature $> \mathbf{F}$
 - Radiation fin temperature $\geq \mathbf{G}$

	A	B	C		D		E	F		G	
			($^{\circ}\text{C}$)	($^{\circ}\text{F}$)	($^{\circ}\text{C}$)	($^{\circ}\text{F}$)		($^{\circ}\text{C}$)	($^{\circ}\text{F}$)	($^{\circ}\text{C}$)	($^{\circ}\text{F}$)
12 class	0/256	10	0	32	85	185	12	2	35.6	90	194
18/24 class	238/256	35	6	42.8	85	185	37	8	46.4	90	194

5.3.2 Four Way Valve Switching

Outline

The four way valve coil is energized/not energized depending on the operation mode.

(Heating: ON, Cooling/Dry/Defrost: OFF)

In order to eliminate the switching sound as the four way valve coil switches from ON to OFF when the heating is stopped, the OFF delay switch of the four way valve is carried out.

Details

OFF delay switch of four way valve

The four way valve coil is energized for 160 seconds after the operation is stopped.

5.3.3 Four Way Valve Operation Compensation

Outline

At the beginning of operation as the four way valve is switched, the pressure difference to activate the four way valve is acquired when the output frequency is higher than a certain fixed frequency, for a certain fixed time.

Details

Starting Conditions

1. When the compressor starts and the four way valve switches from OFF to ON
2. When the four way valve switches from ON to OFF during operation
3. When the compressor starts after resetting
4. When the compressor starts after the fault of four way valve switching

The lower limit of frequency keeps **A** Hz for **B** seconds for any of the conditions above.

When the outdoor temperature is above **C** in heating, the frequency decreases depending on the outdoor temperature.

	09 class		12 class		15 class		18/24 class	
	Cooling	Heating	Cooling	Heating	Cooling	Heating	Cooling	Heating
A (Hz)	40	54	24	34	48		46	48
B (seconds)	60		60		70		60	
C	(°C)	10	10		15		15	
	(°F)	50	50		59		59	

5.3.4 3-Minute Standby

Turning on the compressor is prohibited for 3 minutes after turning off.

The function is not used when defrosting.

5.3.5 Compressor Protection Function

When turning the compressor from OFF to ON, the upper limit of frequency is set as follows.

The function is not used when defrosting.

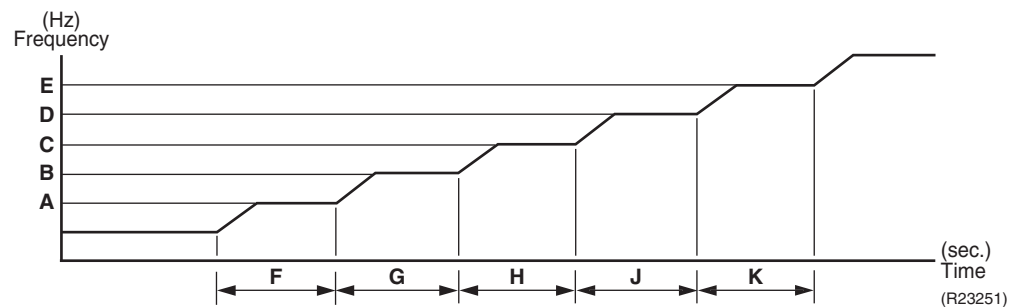

	09 class	12 class	15 class	15 class ★	18/24 class
A (Hz)	40	24	52	35	55/48 ★
B (Hz)	54	34	68	52	65
C (Hz)	72	44	80	62	80
D (Hz)	90	56	98	80	90
E (Hz)	100	78	—	100	100
F (seconds)	180	180	300	1300	240
G (seconds)	420	420	200	250	200
H (seconds)	180	180	460	300	200
J (seconds)	120	120	200	200	120
K (seconds)	400	180	—	120	120

★: Values refer to 15/18/24 class only, when outside temperature is lower than -15°C (5°F).

5.4 Discharge Pipe Temperature Control

Outline

The discharge pipe temperature is used as the internal temperature of the compressor. If the discharge pipe temperature rises above a certain level, the upper limit of frequency is set to keep the discharge pipe temperature from rising further.

Details

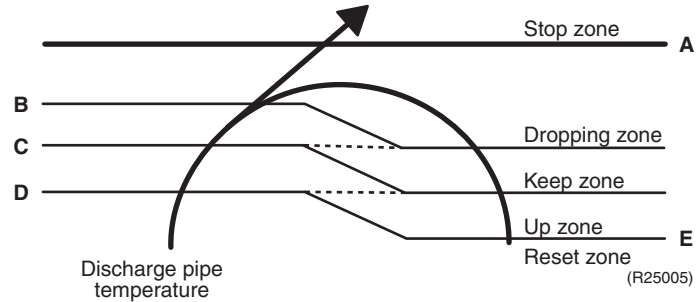

Zone	Control
Stop zone	When the temperature reaches the stop zone, the compressor stops.
Dropping zone	The upper limit of frequency decreases.
Keep zone	The upper limit of frequency is kept.
Up zone	The upper limit of frequency increases.
Reset zone	The upper limit of frequency is canceled.

	09 class		12/18/24 class		15 class	
	(°C)	(°F)	(°C)	(°F)	(°C)	(°F)
A	110	230.0	120	248.0	110	230.0
B	103	217.4	111	231.8	103	217.4
C	98	208.4	109	228.2	101.5	214.7
D	93	199.4	107	224.6	100	212.0
E	88	190.4	107	224.6	95	203.0

5.5 Input Current Control

Outline

The microcomputer calculates the input current while the compressor is running, and sets the frequency upper limit based on the input current.

In case of heat pump models, this control is the upper limit control of the frequency and takes priority over the lower limit control of four way valve operation compensation.

Details

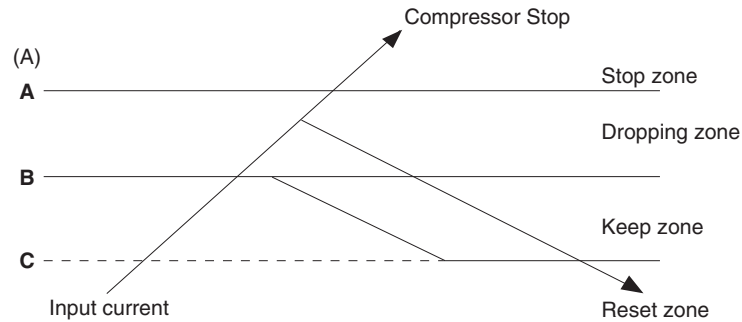

(R23249)

Frequency control in each zone

Stop zone

- After the input current remains in the stop zone for 2.5 seconds, the compressor is stopped.

Dropping zone

- The upper limit of the compressor frequency is defined as operation frequency – 2 Hz.
- After this, the output frequency is lowered by 2 Hz every second until it reaches the keep zone.

Keep zone

- The present maximum frequency goes on.

Reset zone

- Limit of the frequency is canceled.

	09 class		12 class		15 class		18/24 class	
	Cooling	Heating	Cooling	Heating	Cooling	Heating	Cooling	Heating
A (A)	12		13		18		20	
B (A)	7.5	8.5	11.5	12	12	12	16.25	18.25
C (A)	6.5	7.5	10.75	11.25	11	11	15.25	17.25

Limitation of current dropping and stop value according to the outdoor temperature

The current drops when outdoor temperature becomes higher than a certain level (depending on the model).

5.6 Freeze-up Protection Control

Outline

During cooling operation, the signal sent from the indoor unit determines the frequency upper limit and prevents freezing of the indoor heat exchanger. The signals from the indoor unit are divided into zones.

Details

The operating frequency limitation is judged with the indoor heat exchanger temperature.

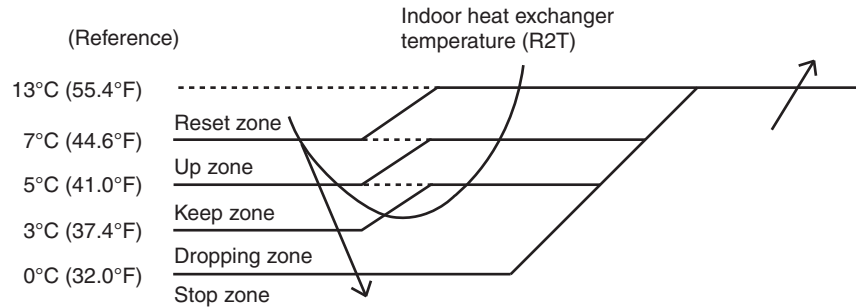

R4003644

5.7 Heating Peak-cut Control

During heating operation, the indoor heat exchanger temperature determines the frequency upper limit to prevent abnormal high pressure.

The operating frequency limitation is judged with the indoor heat exchanger temperature.

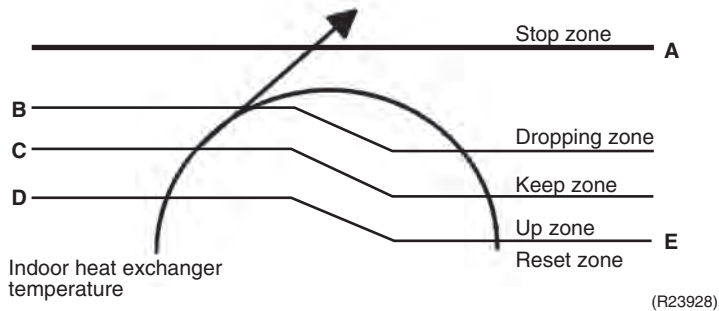

(R23928)

Zone	Control
Stop zone	When the temperature reaches the stop zone, the compressor stops.
Dropping zone	The upper limit of frequency decreases.
Keep zone	The upper limit of frequency is kept.
Up zone	The upper limit of frequency increases.
Reset zone	The upper limit of frequency is canceled.

	09/12 class		15 class		18/24 class	
	(°C)	(°F)	(°C)	(°F)	(°C)	(°F)
A	59	138.2	60	140.0	60	140.0
B ★	55	131.0	54	129.2	56	134.6
C ★	52	125.6	51	123.8	53	129.2
D ★	50	122.0	49	120.2	51	125.6
E	45	113.0	44	111.2	46	116.6

★: The valves might drop when the outdoor temperature is low to protect the compressor.

5.8 Outdoor Fan Control

1. **Fan ON control to cool down the electrical box**
The outdoor fan is turned ON when the electrical box temperature is high while the compressor is OFF.
2. **Fan OFF control during defrosting**
The outdoor fan is turned OFF while defrosting.
3. **Fan OFF delay when stopped**
The outdoor fan is turned OFF 60 ~ 70 seconds after the compressor stops.
4. **Fan speed control for pressure difference upkeep**
The rotation speed of the outdoor fan is controlled for keeping the pressure difference during cooling operation with low outdoor temperature.
 - When the pressure difference is low, the rotation speed of the outdoor fan is reduced.
 - When the pressure difference is high, the rotation speed of the outdoor fan is controlled as well as normal operation.
5. **Fan speed control during forced operation**
The outdoor fan is controlled as well as normal operation during forced operation.
6. **Fan speed control during POWERFUL operation**
The rotation speed of the outdoor fan is increased during POWERFUL operation.
7. **Fan speed control during indoor/outdoor unit quiet operation**
The rotation speed of the outdoor fan is reduced by the command of the indoor/outdoor unit quiet operation.
8. **Fan ON/OFF control when operation (cooling, heating, dry) starts/stops**
The outdoor fan is turned ON when the operation starts. The outdoor fan is turned OFF when the operation stops.

5.9 Liquid Compression Protection Function

Outline

The compressor stops according to the outdoor temperature for protection.

Details

Operation stops depending on the outdoor temperature.

The compressor turns off under the conditions that the system is in cooling operation and the outdoor temperature is below 0°C (32°F).

However, the operating range can be extended to the lowest temperature of -20°C (-4°F) by changing facility setting. Refer to page 217 for details of facility setting.

5.10 Defrost Control

Outline

Defrosting is carried out by the cooling cycle (reverse cycle). The defrosting time or outdoor heat exchanger temperature must be more than a certain value to finish defrosting.

Details

Conditions for Starting Defrost

- The starting conditions are determined with the outdoor temperature and the outdoor heat exchanger temperature.
- The system is in heating operation.
- The compressor operates for 6 minutes.
- More than **A** minutes (depending on the duration of the previous defrost control) of accumulated time have passed since the start of the operation, or ending the previous defrosting.

Conditions for Canceling Defrost

The judgment is made with the outdoor heat exchanger temperature (**B**).

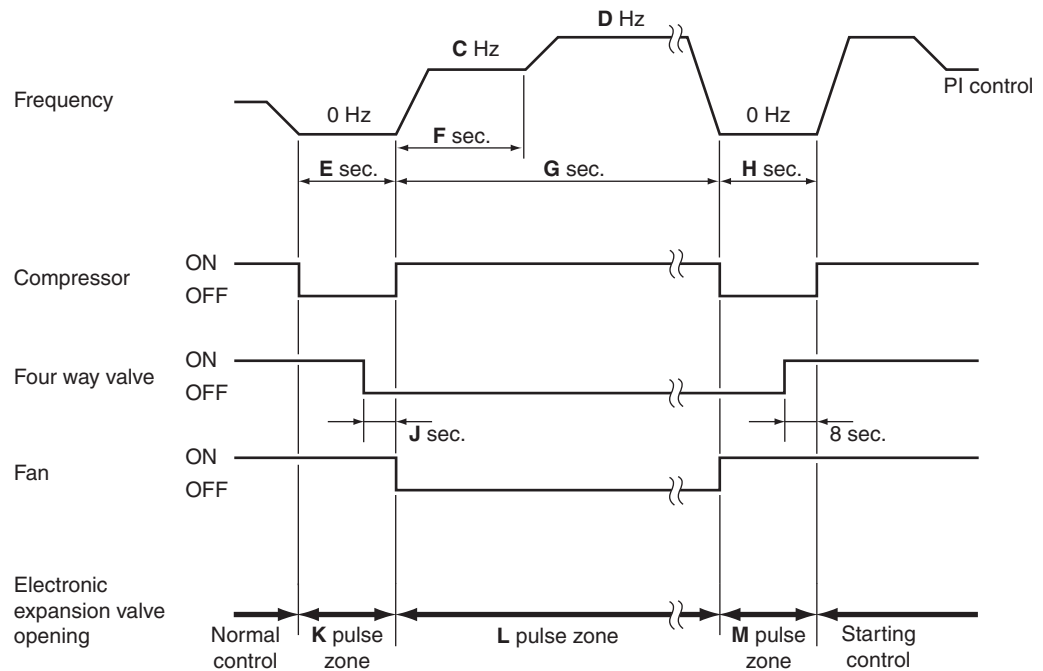

(R21661)

	09 class	12 class	15 class	18/24 class
A (minute)	20 ~ 25	20 ~ 25	44	15 ~ 25
B	(°C)	2 ~ 20	2 ~ 20	6 ~ 12
	(°F)	35.6 ~ 68.0	35.6 ~ 68.0	42.8 ~ 86.0
C (Hz)	64	40	48	48
D (Hz)	64	40	70	54
E (seconds)	40	40	60	60
F (seconds)	60	60	60	120
G (seconds)	510	510	340	340
H (seconds)	50	50	90	60
J (seconds)	8	8	5	8
K (pulse)	400	400	450	450
L (pulse)	300	300	300 ~ 450	400
M (pulse)	350	350	200	450

5.11 Electronic Expansion Valve Control

Outline

The following items are included in the electronic expansion valve control.

Electronic expansion valve is fully closed

1. Electronic expansion valve is fully closed when turning on the power.
2. Pressure equalizing control

Open Control

1. Electronic expansion valve control when starting operation
2. Electronic expansion valve control when the frequency changes
3. Electronic expansion valve control for defrosting
4. Electronic expansion valve control when the discharge pipe temperature is abnormally high
5. Electronic expansion valve control when the discharge pipe thermistor is disconnected

Feedback Control

Target discharge pipe temperature control

Details

The followings are the examples of electronic expansion valve control for each operation mode.

	Power on ; Compressor stop	Operation start	Frequency change under starting control	During target discharge pipe temperature control	Frequency change under target discharge pipe temperature control	Discharge pipe thermistor disconnection	Frequency change under discharge pipe thermistor disconnection control	During defrost control
Starting operation control	—	●	—	—	—	—	—	—
Control when the frequency changes	—	—	●	—	●	—	—	—
Target discharge pipe temperature control	—	—	—	●	—	—	—	—
Discharge pipe thermistor disconnection control	—	—	—	—	—	●	●	—
High discharge pipe temperature control	—	●	●	●	●	—	—	—
Defrost control (heating only)	—	—	—	—	—	—	—	●
Pressure equalizing control	●	—	—	—	—	—	—	—
Opening limit control	—	●	●	●	●	●	●	—

● : Available

— : Not available

R4003560

5.11.1 Initialization as Power Supply On

The electronic expansion valve is initialized (fully closed) when the power is turned on. Then, the valve opening position is set and the pressure is equalized.

5.11.2 Pressure Equalizing Control

When the compressor is stopped, the pressure equalizing control is activated. The electronic expansion valve opens, and develops the pressure equalization.

5.11.3 Opening Limit Control

The maximum and minimum opening of the electronic expansion valve are limited.

	09/12 class	15 class	18/24 class
Maximum opening (pulse)	470	480	490
Minimum opening (pulse)	32	52	52

The electronic expansion valve is fully closed when cooling operation stops, and is opened at a fixed degree during defrosting.

5.11.4 Starting Operation Control

The electronic expansion valve opening is controlled when the operation starts, thus preventing superheating or liquid compression.

5.11.5 Control when the Frequency Changes

When the target discharge pipe temperature control is active, if the target frequency changes to a specified value in a certain time period, the target discharge pipe temperature control is canceled and the target opening of the electronic expansion valve is changed according to the frequency shift.

5.11.6 High Discharge Pipe Temperature Control

When the compressor is operating, if the discharge pipe temperature exceeds a certain value, the electronic expansion valve opens and the refrigerant runs to the low pressure side.

This procedure lowers the discharge pipe temperature.

5.11.7 Discharge Pipe Thermistor Disconnection Control

Outline

The disconnection of the discharge pipe thermistor is detected by comparing the discharge pipe temperature with the condensation temperature. If the discharge pipe thermistor is disconnected, the electronic expansion valve opens according to the outdoor temperature and the operation frequency, operates for a specified time, and then stops.

After 3 minutes, the operation restarts and checks if the discharge pipe thermistor is disconnected. If the discharge pipe thermistor is disconnected, the system stops after operating for a specified time.

If the disconnection is detected repeatedly, the system is shut down. When the compressor runs for 60 minutes without any error, the error counter is reset.

Details

Determining thermistor disconnection

When the starting control finishes, the detection timer for disconnection of the discharge pipe thermistor (**A** seconds) starts. When the timer is over, the following adjustment is made.

1. When the operation mode is cooling

When the following condition is fulfilled, the discharge pipe thermistor disconnection is ascertained.

Discharge pipe temperature $+6^{\circ}\text{C}$ ($+10.8^{\circ}\text{F}$) $<$ outdoor heat exchanger temperature

2. When the operation mode is heating

When the following condition is fulfilled, the discharge pipe thermistor disconnection is ascertained.

Discharge pipe temperature $+6^{\circ}\text{C}$ ($+10.8^{\circ}\text{F}$) $<$ indoor heat exchanger temperature

	A (seconds)		
	09/12 class	15 class	18/24 class
Other than below	720	540	1020
Heating (When outdoor temperature is below -15°C (5°F))	1200	1800	1800

When the thermistor is disconnected

When the disconnection is ascertained, the compressor continues operation for 9 minutes and then stops.

If the compressor stops repeatedly, the system is shut down.

5.11.8 Target Discharge Pipe Temperature Control

The target discharge pipe temperature is obtained from the indoor and outdoor heat exchanger temperature, and the electronic expansion valve opening is adjusted so that the actual discharge pipe temperature becomes close to the target discharge pipe temperature. (Indirect SH (superheating) control using the discharge pipe temperature)

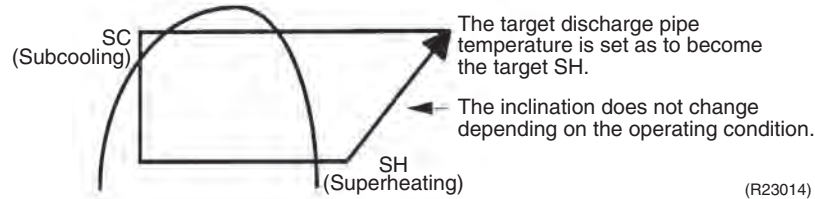

The electronic expansion valve opening and the target discharge pipe temperature are adjusted every **A** seconds. The opening degree of the electronic expansion valve is adjusted by the following.

- Target discharge pipe temperature
- Actual discharge pipe temperature
- Previous discharge pipe temperature

	09/12/15 class	18/24 class
A (seconds)	10 ~ 30★	20

★ The time depends on the opening of the electronic expansion valve.

5.12 Malfunctions

5.12.1 Sensor Malfunction Detection

Sensor malfunction can be detected in the following thermistor:

1. Outdoor heat exchanger thermistor
2. Discharge pipe thermistor
3. Radiation fin thermistor
4. Outdoor temperature thermistor

5.12.2 Detection of Overcurrent and Overload

Outline

An excessive output current is detected and the OL temperature is observed to protect the compressor.

Details

- If the OL (compressor head) temperature exceeds 120 ~ 130°C (248 ~ 266°F) (depending on the model), the system shuts down the compressor.
- If the inverter current exceeds 12.0 ~ 20.0 A (depending on the model), the system shuts down the compressor.
The upper limit of the current decreases when the outdoor temperature exceeds a certain level.

Part 5

Remote Controller

1. Applicable Remote Controller	92
2. ARC466A21	93
3. ARC466A37	95
4. ARC480A8	97
5. BRC082A43	98
6. BRC1E73	100

1. Applicable Remote Controller

Series	Model Name	Wireless Remote Controller	Reference Page	Wired Remote Controller	Reference Page
FTX-N/U	FTX09NMVJU	ARC480A8	97	BRC944B2 (option)	—
	FTX12NMVJU				
	FTX15NMVJU				
	FTX18UVJU	ARC466A37	95		
	FTX24UVJU				
FVXS-N	FVXS09NVJU	ARC466A21	93	—	—
	FVXS12NVJU				
	FVXS15NVJU				
FDMQ-R	FDMQ12RVJU	BRC082A43	98	BRC1E73	100
	FDMQ18RVJU				
	FDMQ24RVJU				



Note

Refer to the operation manual of applicable model for details. You can download operation manuals from Daikin Business Portal:

Daikin Business Portal → Document Search → Item Category → Installation/Operation Manual
(URL: https://global1d.daikin.com/business_portal/login/)

2. ARC466A21

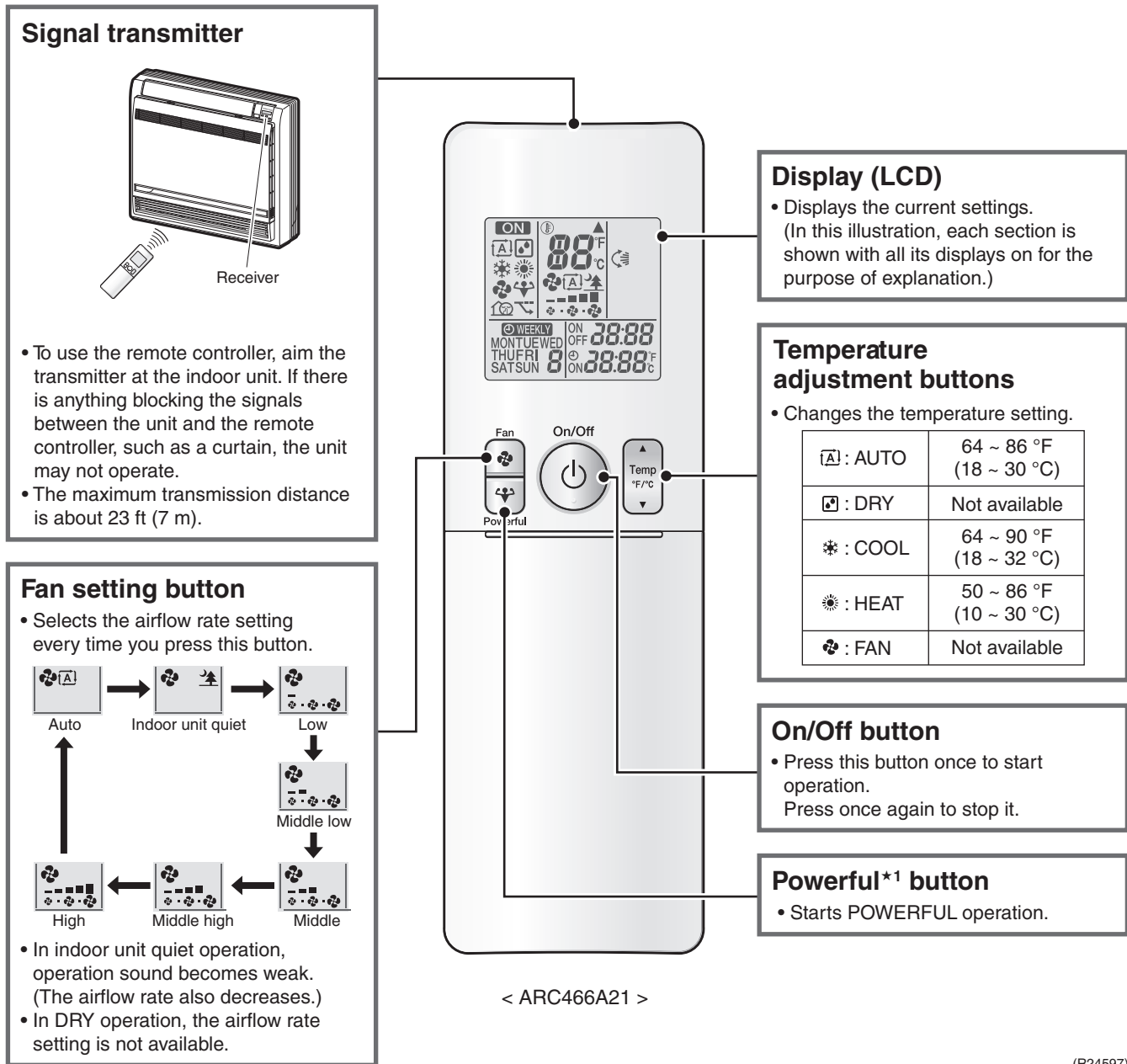

(R24597)



Reference

Refer to the following pages for details.

★1 POWERFUL operation P.57

Open the Front Cover

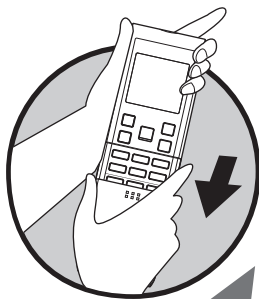
**Mode button**

- Selects the operation mode.

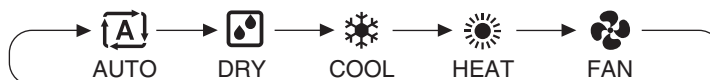
**ECONO^{★2} button**

- Starts ECONO operation.

Swing^{★3} button

- Adjusts the airflow direction.
- When you press **Swing** button, the flap moves up and down. The flap stops when you press **Swing** button again.

Quiet button

- Starts OUTDOOR UNIT QUIET operation.
- OUTDOOR UNIT QUIET operation is not available in FAN and DRY operation.
- OUTDOOR UNIT QUIET operation and POWERFUL operation cannot be used at the same time. Priority is given to the function you pressed last.

Off Timer button (NIGHT SET mode)

- Press this button and adjust the day and time with **Select** button.
- Press this button again to complete TIMER setting.

Timer Cancel button

- Cancels the timer setting.
- Cannot be used for the WEEKLY TIMER operation.

Select button

- It changes the ON/OFF TIMER and WEEKLY TIMER settings.

Weekly buttons (WEEKLY TIMER Operation^{★4})

- Weekly
- Weekly : Weekly button
- Program button
- Copy
- Copy button
- Back
- Back button
- Next
- Next button

On Timer button

- Press this button and adjust the day and time with **Select** button. Press this button again to complete TIMER setting.

Clock^{★5} button

(R25077)

**Reference**

Refer to the following pages for details.

★2 ECONO operation	P.55
★3 Auto-swing	P.46
★4 WEEKLY TIMER operation	P.59
★5 Clock setting	P.58

3. ARC466A37

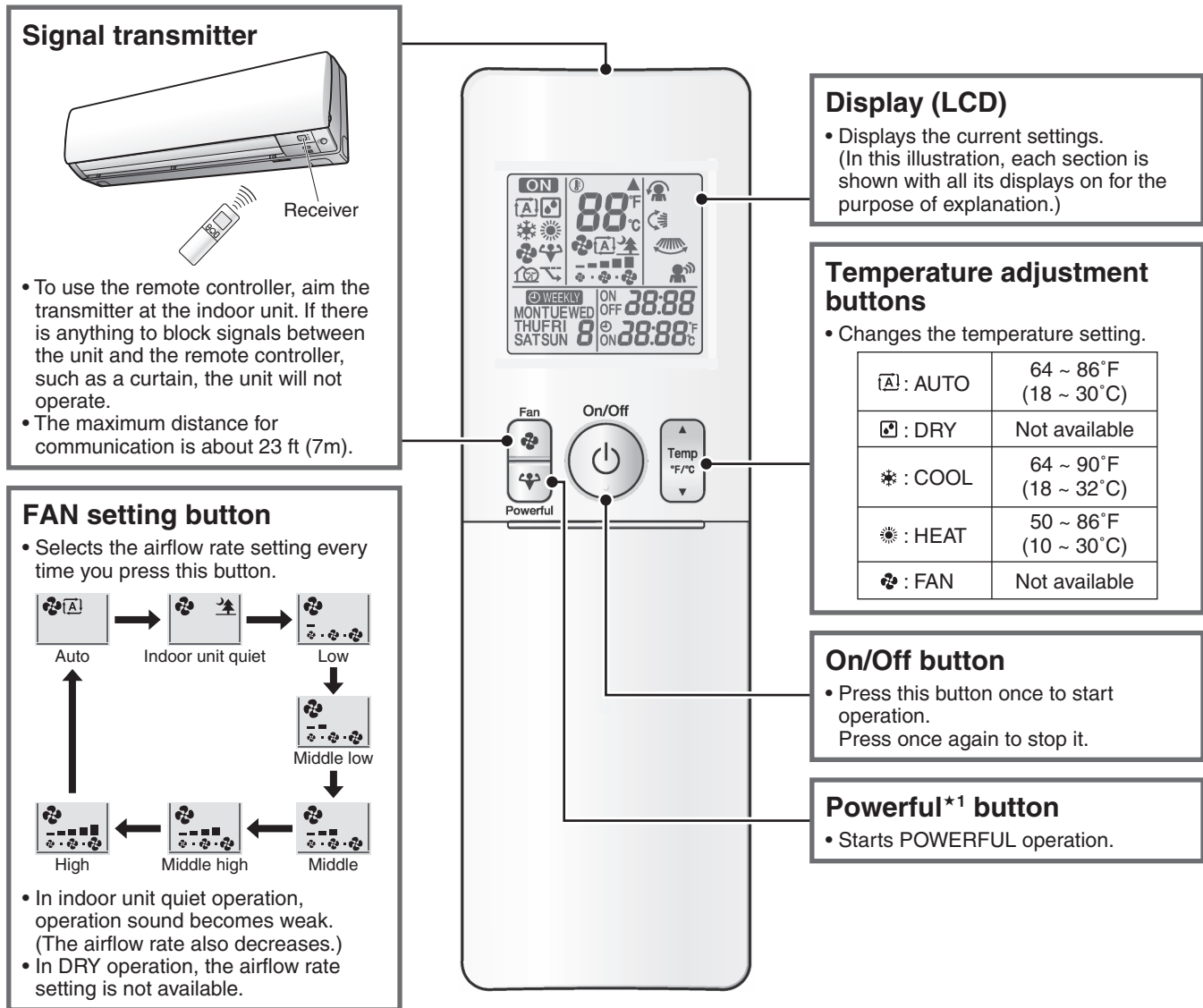

< ARC466A37 >

R5000260



Reference

Refer to the following pages for details.

★1 POWERFUL operation

P.57

Open the Front Cover

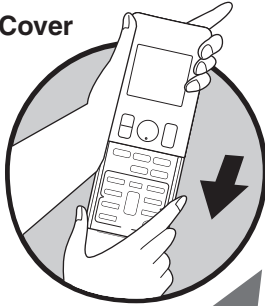

Mode button

• Selects the operation mode.



Comfort/Sensor button (COMFORT AIRFLOW Operation*2 /INTELLIGENT EYE Operation*3)

• Every time you press **Comfort/Sensor** button, the setting changes in the following order.

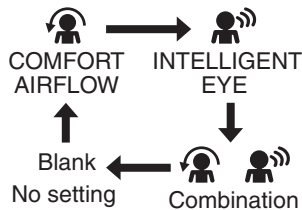

Off Timer button (NIGHT SET mode)

• Press this button and adjust the day and time with **Select** button. Press this button again to complete **TIMER** setting.

Timer Cancel button

• Cancels the timer setting.
• It cannot be used for the **WEEKLY TIMER** operation.

Select button

• Changes the **ON/OFF TIMER** and **WEEKLY TIMER** settings.

Clock*7 button

On Timer button

• Press this button and adjust the day and time with **Select** button. Press this button again to complete **TIMER** setting.

Econo*4/Quiet button

• Every time you press **Econo/Quiet** button, the setting changes in the following order.

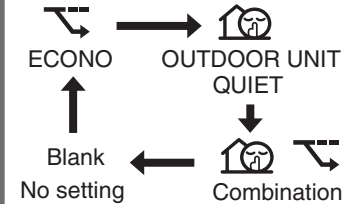

• **OUTDOOR UNIT QUIET** operation is not available in **FAN** and **DRY** operation.
• **OUTDOOR UNIT QUIET** operation and **ECONO** operation cannot be used at the same time with **POWERFUL** operation. Priority is given to the function you pressed last.

Swing*5 buttons

• Adjusts the airflow direction.
• When you press **Swing** button, the flap moves up and down, or (and) the louver moves right and left. The flap (louver) stops when you press **Swing** button again.

Weekly buttons (WEEKLY TIMER Operation*6)

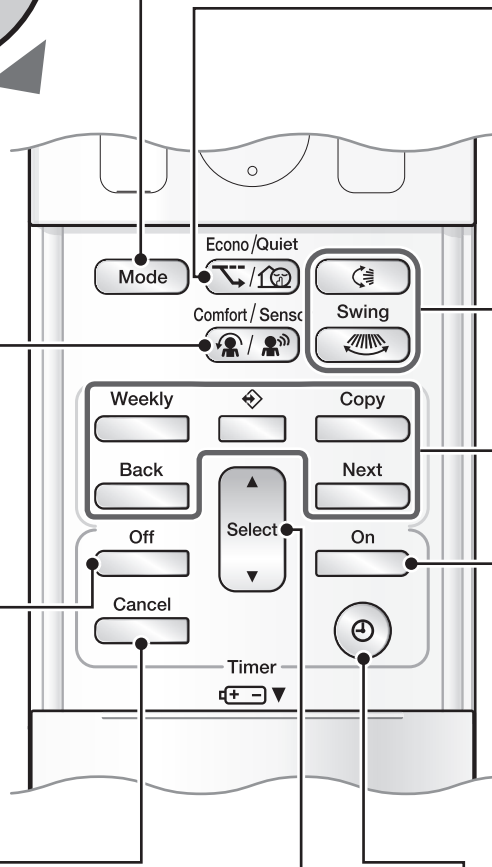
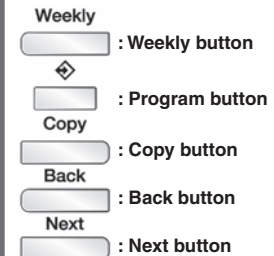

Reference Refer to the following pages for details.

- ★2 COMFORT AIRFLOW operation P.49
- ★3 INTELLIGENT EYE operation P.56
- ★4 ECONO operation P.55

- P.49
- P.56
- P.55

- ★5 Auto-swing P.46
- ★6 WEEKLY TIMER operation P.59
- ★7 Clock setting P.58

R5000261

4. ARC480A8

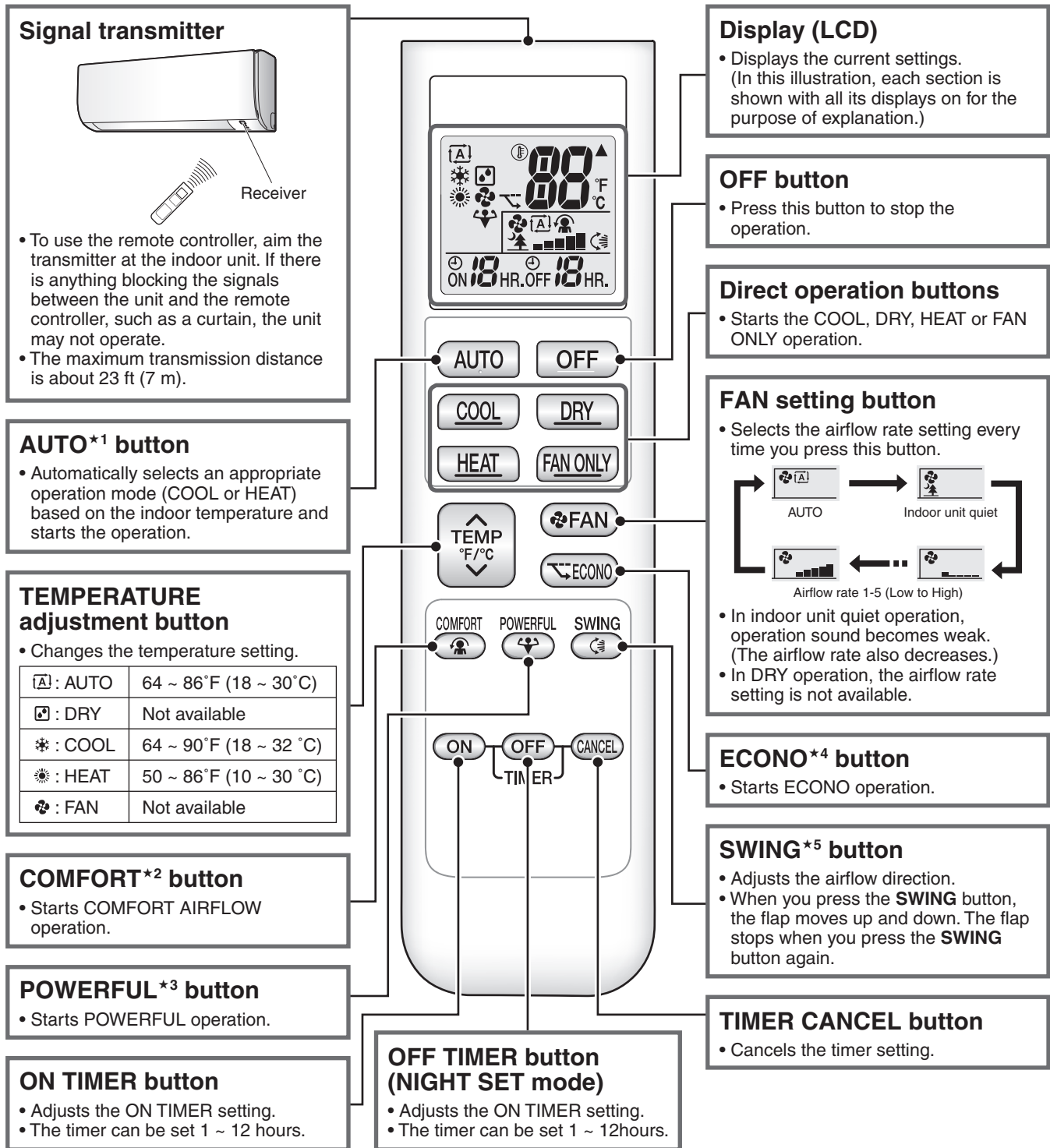

< ARC480A8 >

R5000259



Reference Refer to the following pages for details.

- ★1 Automatic cooling/heating changeover P.52
- ★2 COMFORT AIRFLOW operation P.49
- ★3 POWERFUL operation P.57

- ★4 ECONO operation P.55
- ★5 Auto-swing P.46

5. BRC082A43

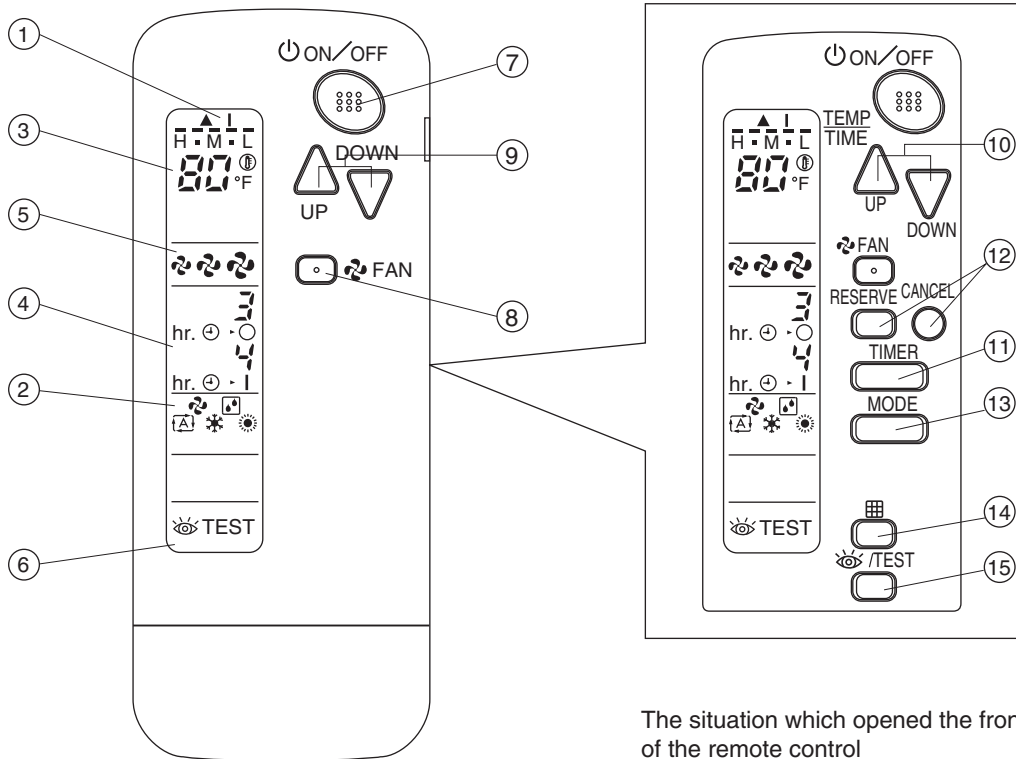





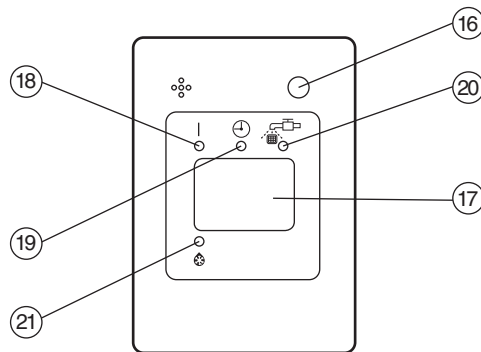







The situation which opened the front cover of the remote control

(R25006)



(R25007)

1	DISPLAY “▲” “I” (SIGNAL TRANSMISSION)	11	TIMER MODE START/STOP BUTTON
	This lights up when a signal is being transmitted.		Use this button for TIMER MODE setting.
2	DISPLAY “” “” “” “” “” (OPERATION MODE)	12	TIMER RESERVE/CANCEL BUTTON
	This display shows the current OPERATION MODE.		Use this button to end timer setting procedure.
3	DISPLAY “” (SET TEMPERATURE)	13	OPERATION MODE SELECTOR BUTTON
	This display shows the set temperature.		Press this button to select OPERATION MODE.
4	DISPLAY “ hr.  hr.” (PROGRAMMED TIME)	14	FILTER SIGN RESET BUTTON
	This display shows PROGRAMMED TIME of the system start or stop.		Refer to the section of MAINTENANCE in the operation manual attached to the indoor unit.
5	DISPLAY “” “” “” (FAN SPEED)	15	INSPECTION/TEST OPERATION BUTTON
	This display shows the set fan speed.		This button is pressed for inspection or test operation. Do not use for normal operation.
6	DISPLAY “ TEST” (INSPECTION/ TEST OPERATION)	16	EMERGENCY OPERATION SWITCH
	When the INSPECTION/TEST OPERATION BUTTON is pressed, the display shows the system mode is in.		This switch is readily used if the remote controller does not work.
7	ON/OFF BUTTON	17	RECEIVER
	Press the button and the system will start. Press the button again and the system will stop.		This receives the signals from the remote controller.
8	FAN SPEED CONTROL BUTTON	18	OPERATING INDICATOR LAMP (Red)
	Press this button to select the fan speed (HIGH, MEDIUM or LOW) of your choice.		This lamp stays lit while the air conditioner runs. It flashes when the unit is in trouble.
9	TEMPERATURE SETTING BUTTON	19	TIMER INDICATOR LAMP (Green)
	Use this button for SETTING TEMPERATURE. (Operates with the front cover of the remote controller closed.)		This lamp stays lit while the timer is set.
10	PROGRAMMING TIMER BUTTON	20	AIR FILTER CLEANING TIME INDICATOR LAMP (Red)
	Use this button for programming “START and/or STOP” time. (Operates with the front cover of the remote controller opened.)		Lights up when it is time to clean the air filter.
		21	DEFROST LAMP (Orange)
			Lights up when the defrosting operation has started. (For cooling only type this lamp does not turn on.)

6. BRC1E73

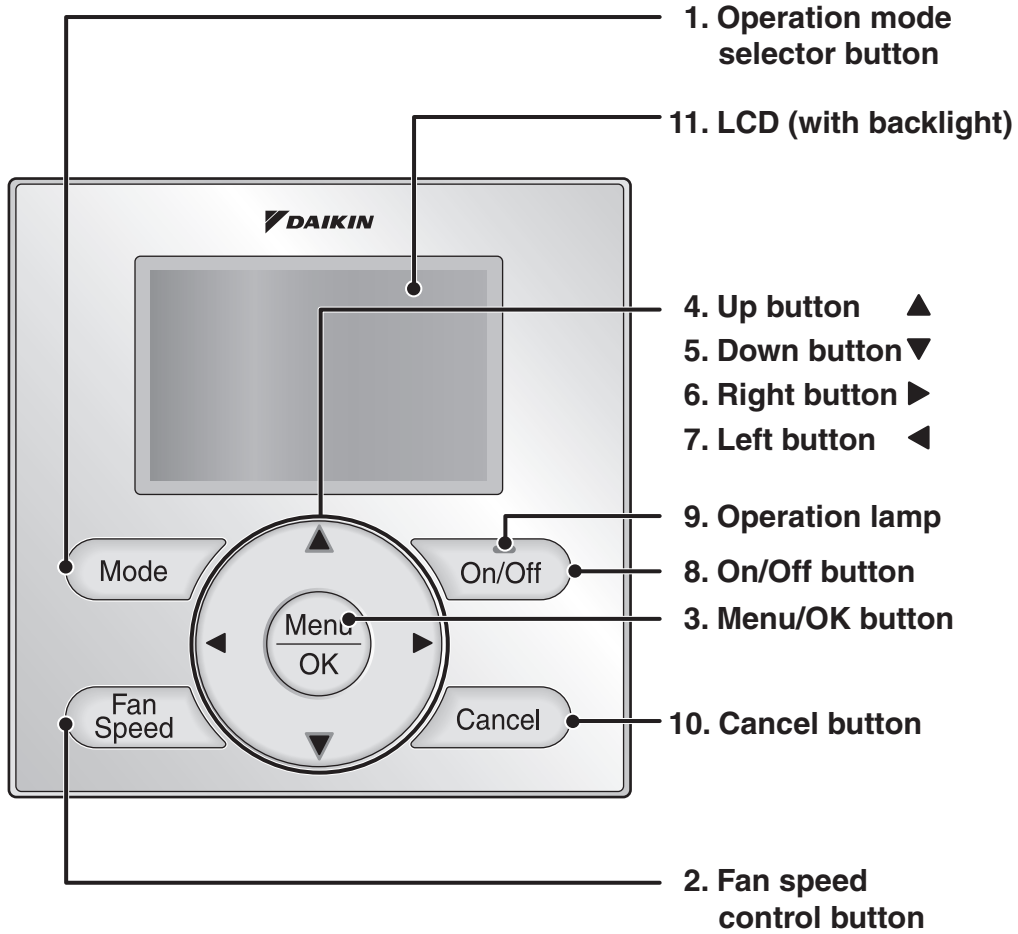

1. Operation mode selector button

- Press this button to select the operation mode of your preference.
- * Available modes vary with the indoor unit model.

2. Fan speed control button

- Press this button to select the fan speed of your preference.
- * Available fan speeds vary with the indoor unit model.

3. Menu/OK button

- Used to enter the main menu.
- Used to enter the selected item.

4. Up button ▲

- Used to raise the setpoint.
- The item above the current selection will be highlighted.
(The highlighted items will be scrolled continuously when the button is continuously pressed.)
- Used to change the selected item.

5. Down button ▼

- Used to lower the setpoint.
- The item below the current selection will be highlighted.
(The highlighted items will be scrolled continuously when the button is continuously pressed.)
- Used to change the selected item.

6. Right button ►

- Used to highlight the next items on the right-hand side.
- Each screen is scrolled in the right-hand direction.

7. Left button ◀

- Used to highlight the next items on the left-hand side.
- Each screen is scrolled in the left-hand direction.

8. On/Off button

- Press this button and system will start.
- Press this button again to stop the system.

9. Operation lamp

- This lamp illuminates solid green during normal operation.
- This lamp flashes if an error occurs.

10. Cancel button

- Used to return to the previous screen.

11. LCD (with backlight)

- The backlight will be illuminated for approximately 30 seconds by pressing any button.
- If two remote controllers are used to control a single indoor unit, only the controller accessed first will have backlight functionality.

Liquid Crystal Display

- Three types of display mode (Standard, Detailed and Simple) are available.
- Standard display is set by default.
- Detailed and Simple displays can be selected in the main menu.

Standard display

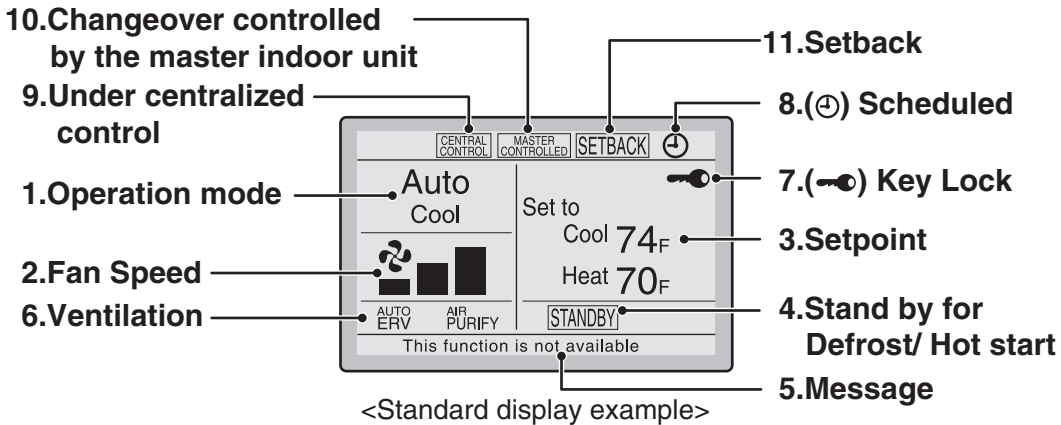

Detailed display

- The airflow direction, clock, and selectable item appear on Detailed display screen in addition to the items appearing on Standard display.

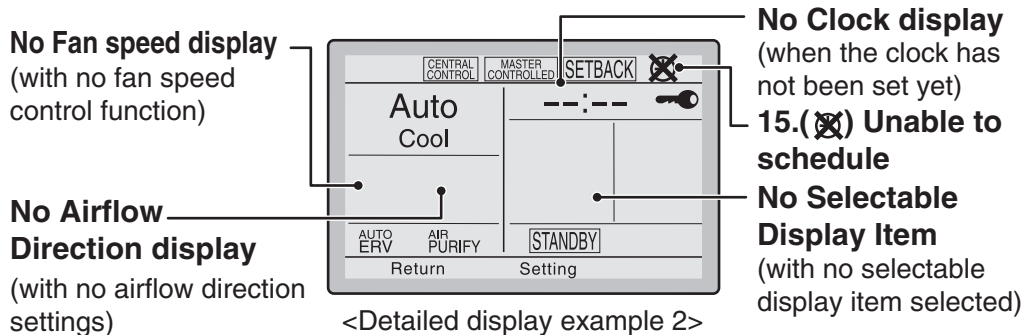
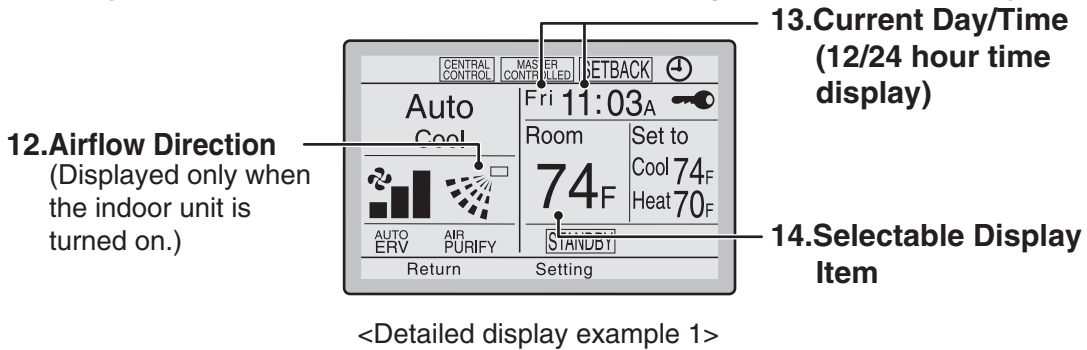

Simple display

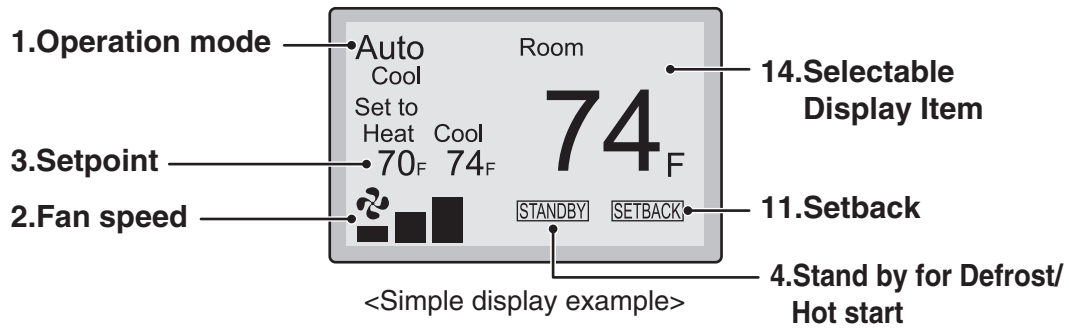

Note for all display modes

- Depending on the field settings, while the indoor unit is stopped, OFF may be displayed instead of the operation mode and/or the setpoint may not be displayed.

1. Operation mode

- Used to display the current operation mode: Cool, Heat, Vent, Fan, Dry or Auto.
- In Auto mode, the actual operation mode (Cool or Heat) will be also displayed.
- Operation mode cannot be changed when OFF is displayed. Operation mode can be changed after starting operation.

2. Fan Speed

- Used to display the fan speed that is set for the indoor unit.
- The fan speed will not be displayed if the connected model does not have fan speed control functionality.

3. Setpoint

- Used to display the setpoint for the indoor unit.
- Use the Celsius/Fahrenheit item in the main menu to select the temperature unit (Celsius or Fahrenheit).

4. Stand by for Defrost/Hot start

“”

If ventilation icon is displayed in this field:

- Indicates that an energy recovery ventilator (ERV) is connected. For details, refer to the Operation Manual of the ERV.

5. Message

The following messages may be displayed.

“**This function is not available**”

- Displayed for a few seconds when an Operation button is pressed and the indoor unit does not provide the corresponding function.
- In a remote control group, the message will not appear if at least one of the indoor units provides the corresponding function.

“**Error: Push Menu button**”

“**Warning: Push Menu button**”

- Displayed if an error or warning is detected.



“**Time to clean filter**”

“**Time to clean element**”

“**Time to clean filter & element**”

- Displayed as a reminder when it is time to clean the filter and/or element.

6. Ventilation

- Displayed when an energy recovery ventilator is connected.
- **Ventilation Mode icon.** “ AUTO ERV BYPASS”
These icons indicate the current ventilation mode (ERV only) (AUTO, ERV, BYPASS).
- **Air Purify ICON** “ AIR PURIFY”
This icon indicates that the air purifying unit (Optional) is in operation.

7. Key Lock

- Displayed when the key lock is set.

8. Scheduled

- Displayed if the Schedule or Off timer is enabled.

9. Under Centralized control “”

- Displayed if the system is under the management of a multi-zone controller (Optional) and the operation of the system through the remote controller is limited.

10. Changeover controlled by the master indoor unit “” (VRV only)

- Displayed when another indoor unit on the system has the authority to change the operation mode between cool and heat.

11. Setback “”

- The setback icon flashes when the unit is turned on by the setback control.

12. Airflow Direction “”

- Displayed when the airflow direction and swing are set.
- If the connected indoor unit model does not include oscillating louvers this item will not be displayed.

13. Current Day/Time (12/24 hour time display)

- Displayed if the clock is set.
- If the clock is not set, “-- : --” will be displayed.
- 12 hour time format is displayed by default.
- Select 12/24 hour time display option in the main menu under “Clock & Calendar”.

14. Selectable Display Item

- Room temperature is selected by default.
- For other choices see the operation manual.

15. ~~Unable~~ Unable to schedule

- Displayed when the clock needs to be set.
- The schedule function will not work unless the clock is set.

7.7	Discharge Pipe Temperature Control	163
7.8	High Pressure Control in Cooling	165
7.9	System Shutdown due to Temperature Abnormality in the Compressor	167
7.10	Compressor Sensor System Abnormality	168
7.11	Position Sensor Abnormality	169
7.12	Thermistor or Related Abnormality (Outdoor Unit)	172
7.13	Electrical Box Temperature Rise	174
7.14	Radiation Fin Temperature Rise	176
7.15	Output Overcurrent Detection	178
7.16	Signal Transmission Error on Outdoor Unit PCB	180
8.	Check	181
8.1	Thermistor Resistance Check	181
8.2	Indoor Fan Motor Connector Check	182
8.3	Power Supply Waveform Check	184
8.4	Electronic Expansion Valve Check	184
8.5	Four Way Valve Performance Check	185
8.6	Inverter Unit Refrigerant System Check	185
8.7	Inverter Analyzer Check	186
8.8	Rotation Pulse Check on the Outdoor Unit PCB	189
8.9	Installation Condition Check	190
8.10	Discharge Pressure Check	190
8.11	Outdoor Fan System Check	191
8.12	Main Circuit Short Check	191
8.13	Power Module Check	194

1. General Problem Symptoms and Check Items

Symptom	Check Item	Measures	Reference Page
The unit does not operate.	Check the power supply.	Check if the rated voltage is supplied.	—
	Check the type of the indoor unit.	Check if the indoor unit type is compatible with the outdoor unit.	—
	Check the outdoor temperature.	Heating/cooling operations are not available when the outdoor temperature is out of the operation limit. Check the reference page for the operation limit.	236
	Diagnose with remote controller indication.	—	123
	Check the remote controller addresses.	Check if address settings for the remote controller and indoor unit are correct.	207
Operation sometimes stops.	Check the power supply.	A power failure of 2 to 10 cycles stops air conditioner operation. (Operation lamp OFF)	—
	Check the outdoor temperature.	Heating/cooling operations are not available when the outdoor temperature is out of the operation limit. Check the reference page for the operation limit.	236
	Diagnose with remote controller indication.	—	123
The unit operates but does not cool, or does not heat.	Check for wiring and piping errors in the connection between the indoor unit and outdoor unit.	—	—
	Check for thermistor detection errors.	Check if the thermistor is mounted securely.	—
	Check for faulty operation of the electronic expansion valve.	Set the unit to cooling operation, and check the temperature of the liquid pipe to see if the electronic expansion valve works.	—
	Diagnose with remote controller indication.	—	123
	Diagnose by service port pressure and operating current.	Check for refrigerant shortage.	—
Large operating noise and vibrations	Check the output voltage of the power module.	—	194
	Check the power module.	—	—
	Check the installation condition.	Check if the required spaces for installation (specified in the installation manual) are provided.	—

2. Troubleshooting with LED

2.1 Indoor Unit

Operation Lamp

The operation lamp blinks when any of the following errors is detected.

- A protection device of the indoor or outdoor unit is activated, or when the thermistor malfunctions.
 - A signal transmission error occurs between the indoor and outdoor units.
- In either case, conduct the diagnostic procedure described in the following pages.

FTX Series

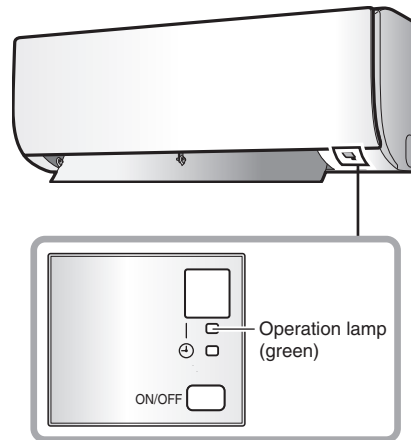

R600066

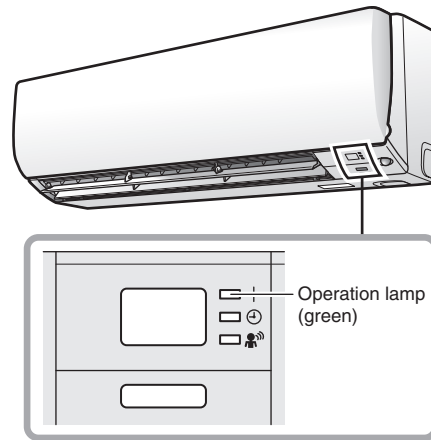

R600067

FVXS Series

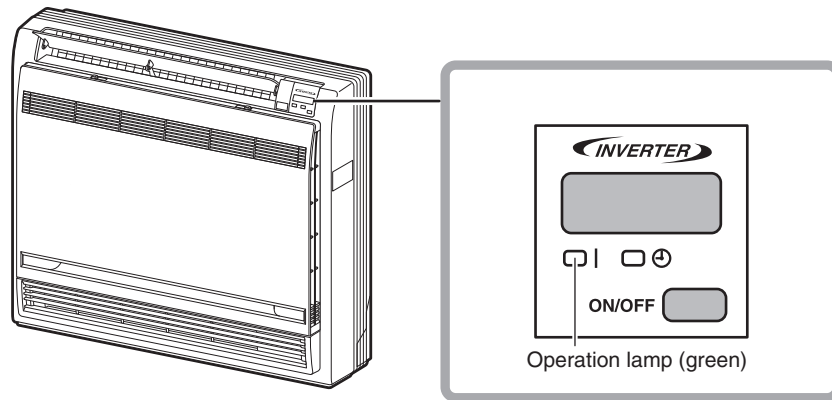

R4003515

FDMQ series with BRC1E73

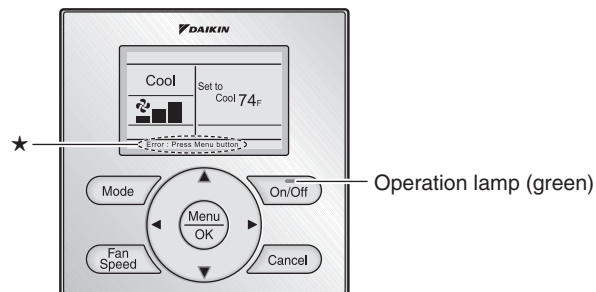

★The error or warning message also blinks on the basic screen.

R4003516

FDMQ series with BRC082A43

For wireless remote controller, a receiver is installed. When the error occurs, the operation lamp on the receiver blinks.

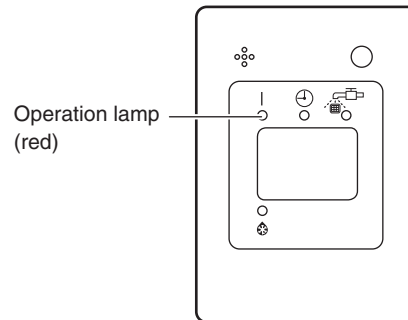

R4003517

2.2 Outdoor Unit

The outdoor unit has one green LED (LED A) on the PCB. When the microcomputer works in order, the LED A blinks. However, the LED A turns OFF while the standby electricity saving function is activated and the power supply is OFF.

Refer to page 34, 36, 38, 39 for the location of LED A.

3. Service Diagnosis

3.1 ARC480 Series

3.1.1 Method 1

1. When **TIMER CANCEL** button is held down for 5 seconds, **00** is displayed on the temperature display screen.
2. Press **TIMER CANCEL** button repeatedly until a long beep sounds.



R6000690



Note(s)

1. A short beep or two consecutive beeps indicate non-corresponding codes.
2. To return to the normal mode, hold **TIMER CANCEL** button down for 5 seconds. When the remote controller is left untouched for 60 seconds, it also returns to the normal mode.
3. Not all the error codes are displayed. When you cannot find the error code, try method 2. Refer to page 112.

- The code indication changes in the sequence shown below.

ARC480A8

No.	Code	No.	Code	No.	Code	No.	Code
1	00	12	H0	23	J3	34	H7
2	R5	13	R6	24	J5	35	U2
3	E7	14	U0	25	J8	36	ER
4	F3	15	C7	26	E5	37	PH
5	F6	16	R3	27	R1	38	FR
6	L3	17	H8	28	E1	39	EB
7	L4	18	H9	29	UR	40	CH
8	L5	19	C9	30	U3	41	J9
9	U4	20	CC	31	UF	42	E3
10	E6	21	C4	32	UH	43	H3
11	H6	22	C5	33	P4		

3.1.2 Method 2

1. Press the center of **TEMP** button and **OFF** button at the same time.

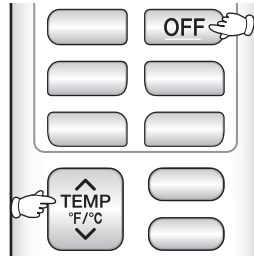

5C is displayed on the LCD.

R6000668

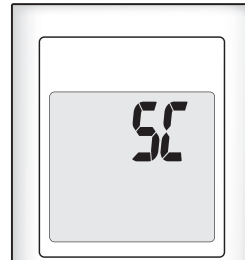

R6000695

2. Select 5C (service check) with **TEMP** ^ or **TEMP** v button.
3. Press **FAN** button to enter the service check mode.

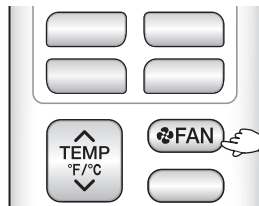

00 is displayed and the left-side number blinks.

R6000669

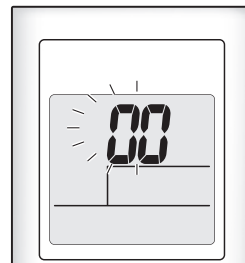

R6000696

4. Press **TEMP** ^ or **TEMP** v button and change the number until you hear the two consecutive beeps or the long beep.

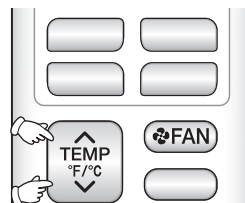

R6000670

5. Diagnose by the sound.
 - Beep: The left-side number does not correspond with the error code.
 - Two consecutive beeps: The left-side number corresponds with the error code but the right-side number does not.

- Long beep: Both the left-side and right-side numbers correspond with the error code.
The numbers indicated when you hear the long beep are the error code.
Refer to page 123.

6. Press **FAN** button.

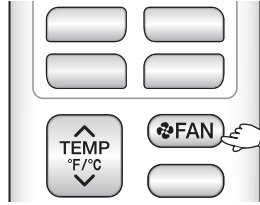

The right-side number blinks.

R6000669

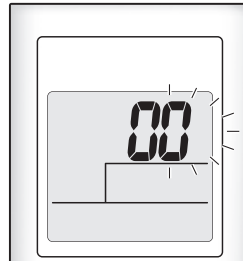

R6000697

7. Press **TEMP ^** or **TEMP v** button and change the number until you hear the long beep.

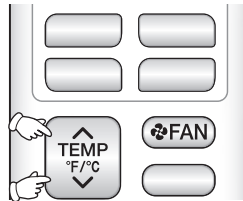

R6000670

8. Diagnose by the sound.

- Beep: The left-side number does not correspond with the error code.
- Two consecutive beeps: The left-side number corresponds with the error code but the right-side number does not.
- Long beep: Both the left-side and right-side numbers correspond with the error code.

9. Determine the error code.

The numbers indicated when you hear the long beep are the error code.
Refer to page 123.

10. Press **FAN** button for 5 seconds to exit from the service check mode.

When the remote controller is left untouched for 60 seconds, it returns to the normal mode also.

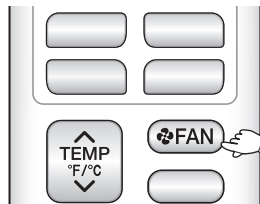

R6000669

3.2 ARC466 Series

3.2.1 Method 1

1. When **Timer Cancel** button is held down for 5 seconds, **00** is displayed on the temperature display screen.
2. Press **Timer Cancel** button repeatedly until a long beep sounds.

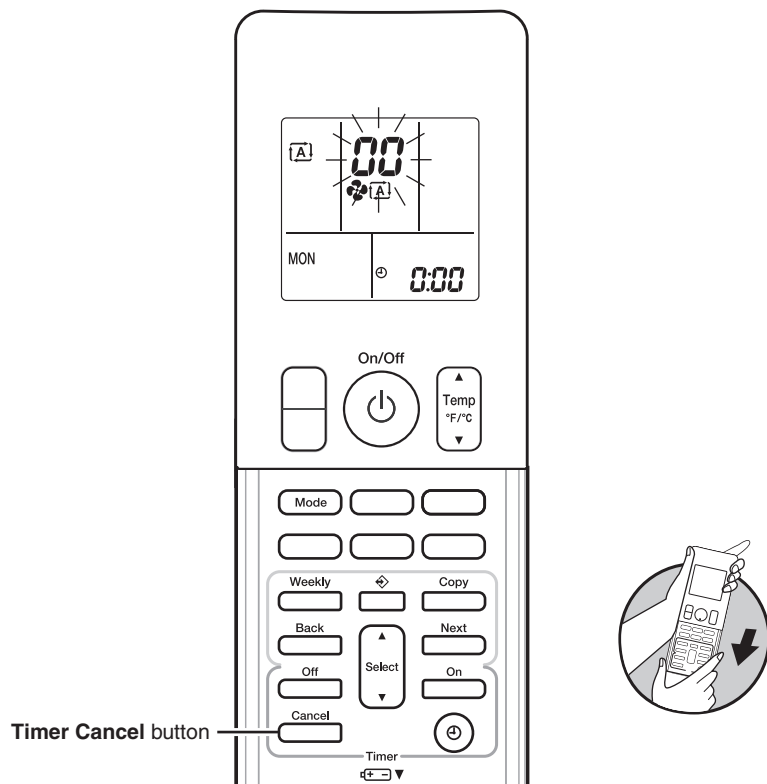

< ARC466 Series >

(R24045)

i Note(s)

1. A short beep or two consecutive beeps indicate non-corresponding codes.
2. To return to the normal mode, hold **Timer Cancel** button down for 5 seconds. When the remote controller is left untouched for 60 seconds, it also returns to the normal mode.
3. Not all the error codes are displayed. When you cannot find the error code, try method 2. Refer to page 115.

- The code indication changes in the sequence shown below.

ARC466A21, A37

No.	Code	No.	Code	No.	Code	No.	Code
1	00	11	H6	21	E5	31	U2
2	R5	12	H0	22	J3	32	ER
3	E7	13	R6	23	U6	33	RY
4	F3	14	U0	24	E5	34	FR
5	F6	15	E7	25	R1	35	H1
6	L3	16	R3	26	E1	36	PS
7	L4	17	H8	27	UR	37	E3
8	L5	18	H9	28	UH	38	H3
9	U4	19	E9	29	P4		
10	E6	20	E4	30	H7		

3.2.2 Method 2

1. Press the center of **Temp** button and **Mode** button at the same time.

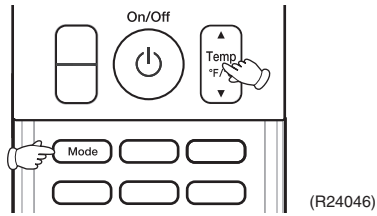

5C is displayed on the LCD.

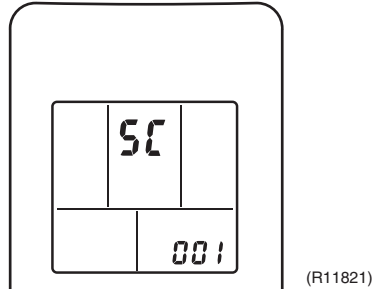

2. Select 5C (service check) with **Temp ▲** or **Temp ▼** button.
3. Press **Mode** button to enter the service check mode.

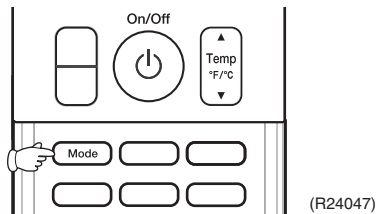

The left-side number blinks.

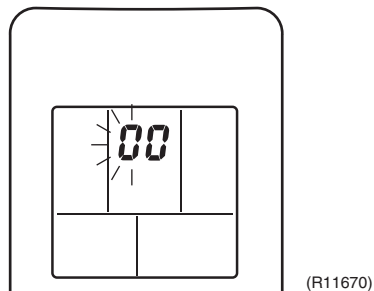

4. Press **Temp ▲** or **Temp ▼** button and change the number until you hear the two consecutive beeps or the long beep.

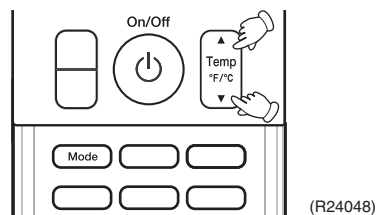

5. Diagnose by the sound.

- Beep: The left-side number does not correspond with the error code.
- Two consecutive beeps: The left-side number corresponds with the error code but the right-side number does not.

- Long beep: Both the left-side and right-side numbers correspond with the error code.
The numbers indicated when you hear the long beep are the error code.
Refer to page 123.

6. Press **Mode** button.

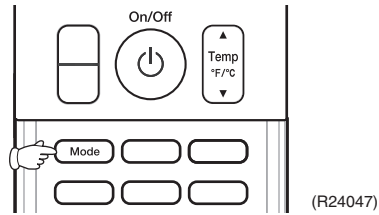

The right-side number blinks.

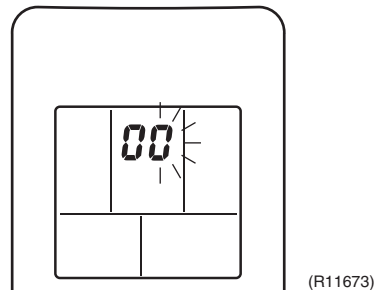

7. Press **Temp ▲** or **Temp ▼** button and change the number until you hear the long beep.

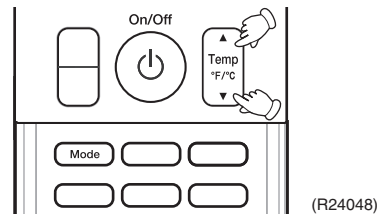

8. Diagnose by the sound.

- Beep: The left-side number does not correspond with the error code.
- Two consecutive beeps: The left-side number corresponds with the error code but the right-side number does not.
- Long beep: Both the left-side and right-side numbers correspond with the error code.

9. Determine the error code.

The numbers indicated when you hear the long beep are the error code.
Refer to page 123.

10. Press **Mode** button for 5 seconds to exit from the service check mode.

When the remote controller is left untouched for 60 seconds, it returns to the normal mode also.

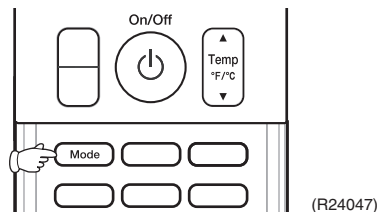

3.3 BRC1E73

Relations Between Modes

On power-up, the message “Checking the connection. Please standby.” will be displayed on the remote controller screen temporarily and then the basic screen will be displayed. To access a mode from the basic screen, refer to the figure below.

When any of the operation buttons is pressed, the backlight will come on and remain lit for about 30 seconds. Be sure to press a button while the backlight is on.

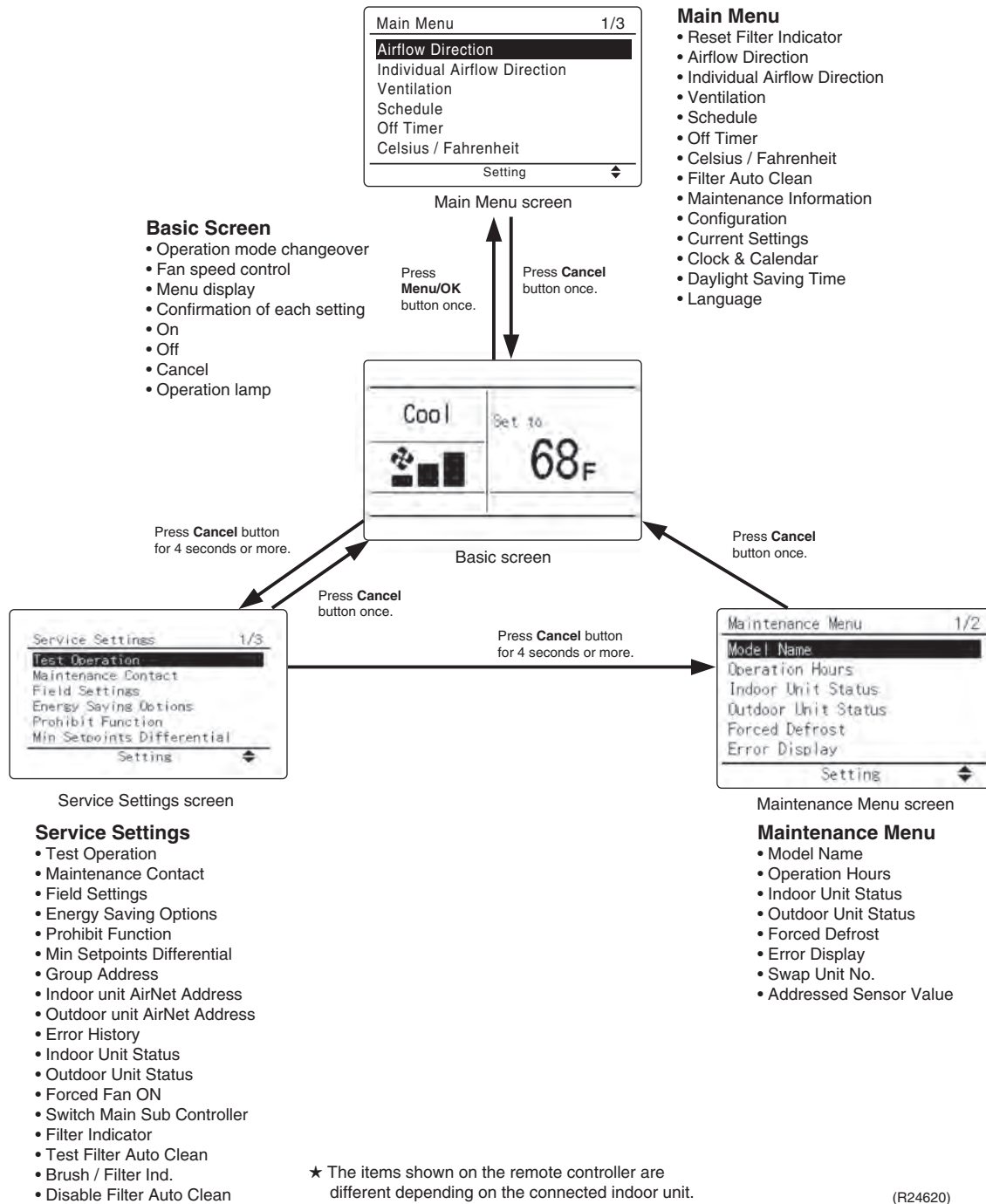

Service Diagnosis

The following message is displayed on the screen when an error (or a warning) occurs during operation.

Check the error code and take the corrective action specified for the particular model.

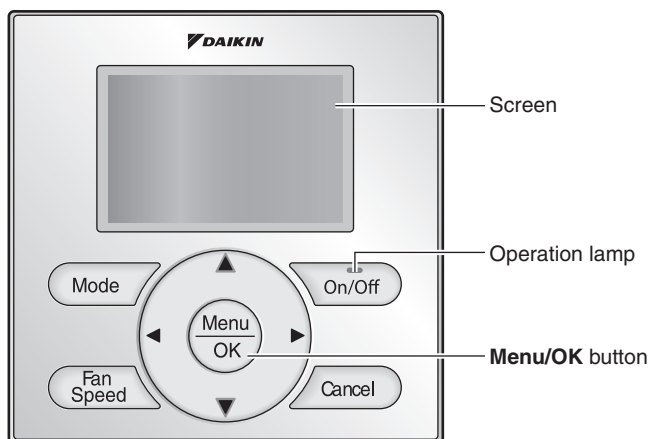

(R18817)

Operation

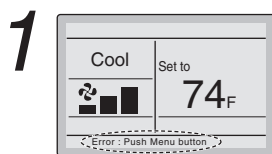

- If an error occurs, either one of the following items will flash in the basic screen.

Error: Push Menu button

- * The Operation lamp will flash.
- * For Simple display, the message is not displayed, and only the Operation lamp flashes.

Warning: Push Menu button

- * The Operation lamp will not flash.
- * For Simple display, the message is not displayed, and the Operation lamp does not flash, either.

- Press **Menu/OK** button.

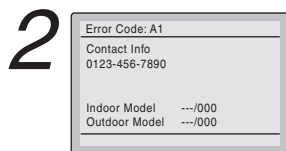
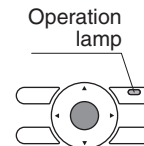

- The error code will flash and the service contact and model name or code may be displayed.
- Notify your Daikin dealer of the Error code and model name or code.

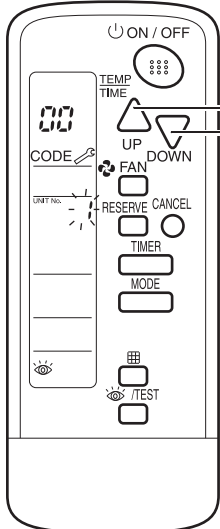
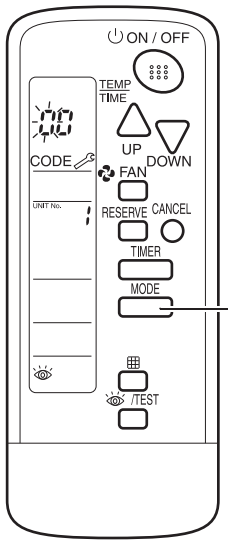
Step	Action								
<p data-bbox="467 258 483 279">2</p>	<p data-bbox="552 258 1481 289">Press UP or DOWN button and change the UNIT No. until the indoor unit starts to beep.</p> <div data-bbox="755 304 1282 829" style="text-align: center;">  <p data-bbox="1079 399 1282 451">UP button DOWN button</p> </div> <p data-bbox="1209 823 1282 844">(R15408)</p> <table border="1" data-bbox="646 913 1404 1150" style="width: 100%; border-collapse: collapse;"> <thead> <tr> <th data-bbox="646 913 1023 945">If you hear...</th> <th data-bbox="1023 913 1404 945">Then...</th> </tr> </thead> <tbody> <tr> <td data-bbox="646 945 1023 982">3 short beeps</td> <td data-bbox="1023 945 1404 982">Follow all steps below.</td> </tr> <tr> <td data-bbox="646 982 1023 1117">1 short beep</td> <td data-bbox="1023 982 1404 1117">Follow steps 3 and 4. Continue the operation in step 4 until you hear a long beep. This long beep indicates that the error code is confirmed.</td> </tr> <tr> <td data-bbox="646 1117 1023 1150">1 long beep</td> <td data-bbox="1023 1117 1404 1150">There is no abnormality.</td> </tr> </tbody> </table>	If you hear...	Then...	3 short beeps	Follow all steps below.	1 short beep	Follow steps 3 and 4. Continue the operation in step 4 until you hear a long beep. This long beep indicates that the error code is confirmed.	1 long beep	There is no abnormality.
If you hear...	Then...								
3 short beeps	Follow all steps below.								
1 short beep	Follow steps 3 and 4. Continue the operation in step 4 until you hear a long beep. This long beep indicates that the error code is confirmed.								
1 long beep	There is no abnormality.								
<p data-bbox="467 1182 483 1203">3</p>	<p data-bbox="552 1182 1481 1234">Press OPERATION MODE SELECTOR button. The left \square (upper digit) indication of the error code blinks.</p> <div data-bbox="747 1249 1299 1785" style="text-align: center;">  <p data-bbox="1096 1543 1299 1596">OPERATION MODE SELECTOR button</p> </div> <p data-bbox="1226 1774 1299 1795">(R24051)</p>								

Step	Action								
<p data-bbox="467 258 488 285">4</p>	<p data-bbox="553 258 1479 285">Press UP or DOWN button to change the error code upper digit until the indoor unit beeps.</p> <div data-bbox="646 304 1396 850"> </div> <p data-bbox="1323 829 1396 850">(R15411)</p> <table border="1" data-bbox="646 919 1404 1060"> <thead> <tr> <th data-bbox="646 919 1023 951">If you hear...</th> <th data-bbox="1023 919 1404 951">Then...</th> </tr> </thead> <tbody> <tr> <td data-bbox="646 951 1023 982">2 short beeps</td> <td data-bbox="1023 951 1404 982">The upper digit matches.</td> </tr> <tr> <td data-bbox="646 982 1023 1014">1 short beep</td> <td data-bbox="1023 982 1404 1014">No digits match.</td> </tr> <tr> <td data-bbox="646 1014 1023 1060">1 long beep</td> <td data-bbox="1023 1014 1404 1060">Both upper and lower digits match.</td> </tr> </tbody> </table>	If you hear...	Then...	2 short beeps	The upper digit matches.	1 short beep	No digits match.	1 long beep	Both upper and lower digits match.
If you hear...	Then...								
2 short beeps	The upper digit matches.								
1 short beep	No digits match.								
1 long beep	Both upper and lower digits match.								
<p data-bbox="467 1098 488 1125">5</p>	<p data-bbox="553 1098 1479 1144">Press OPERATION MODE SELECTOR button. The right 0 (lower digit) indication of the error code blinks.</p> <div data-bbox="755 1165 1299 1701"> </div> <p data-bbox="1226 1690 1299 1711">(R24052)</p>								

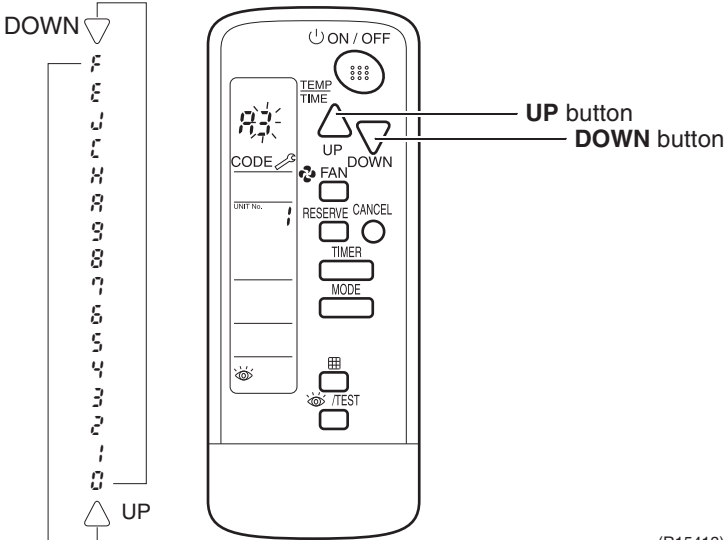
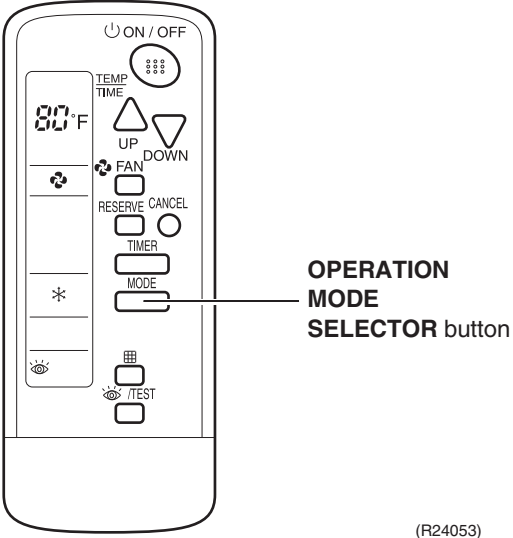
Step	Action						
<p>6</p>	<p>Press UP or DOWN button and change the error code lower digit until the indoor unit generates long beep.</p>  <p style="text-align: right;">(R15413)</p> <table border="1" data-bbox="646 919 1401 1029"> <thead> <tr> <th>If you hear...</th> <th>Then...</th> </tr> </thead> <tbody> <tr> <td>2 short beeps</td> <td>No digits match.</td> </tr> <tr> <td>1 long beep</td> <td>Both upper and lower digits match.</td> </tr> </tbody> </table>	If you hear...	Then...	2 short beeps	No digits match.	1 long beep	Both upper and lower digits match.
If you hear...	Then...						
2 short beeps	No digits match.						
1 long beep	Both upper and lower digits match.						
<p>7</p>	<p>Press OPERATION MODE SELECTOR button to return to the normal mode. If you do not press any button for 1 minute, the remote controller automatically returns to the normal mode.</p>  <p style="text-align: right;">(R24053)</p>						

4. Error Codes and Description

	Error Codes	Description	Reference Page		
			FTX	FVXS	FDMQ
System	00	Normal	—	—	—
	U0★	Refrigerant shortage	—	—	—
	U2	Low-voltage detection or over-voltage detection	133	133	146
	U4	Signal transmission error (between indoor unit and outdoor unit)	135	135	148
	U5	Signal transmission error (between indoor unit and remote controller)	—	—	150
	U8	Signal transmission error (between MAIN/SUB remote controller)	—	—	151
	UR	Unspecified voltage (between indoor unit and outdoor unit)	137	137	152
Indoor Unit	R1	Indoor unit PCB abnormality	124	124	138
	R3	Drain level control system abnormality	—	—	139
	R5	Freeze-up protection control/heating peak-cut control	126	126	—
	R6	Indoor fan motor (DC motor) or related abnormality	128	128	140
	R8	Indoor fan PCB abnormality	—	—	142
	RF	Humidifier or related abnormality	—	—	143
	E4	Indoor heat exchanger thermistor or related abnormality	132	132	144
	E5		—	—	144
	E9	Room temperature thermistor or related abnormality	132	132	144
EJ	Remote controller thermistor abnormality	—	—	145	
Outdoor Unit	E1	Outdoor unit PCB abnormality	153		
	E5★	OL activation (compressor overload)	154		
	E6★	Compressor lock	157		
	E7★	DC fan lock	158		
	E8	Input overcurrent detection	159		
	E8	Four way valve abnormality	161		
	F3	Discharge pipe temperature control	163		
	F6	High pressure control in cooling	165		
	F8	System shutdown due to temperature abnormality in the compressor	167		
	H0	Compressor system sensor abnormality	168		
	H6	Position sensor abnormality	169		
	H9	Outdoor temperature thermistor or related abnormality	172		
	J3★	Discharge pipe thermistor or related abnormality	172		
	J5	Outdoor heat exchanger thermistor or related abnormality	172		
	L3	Electrical box temperature rise	174		
	L4	Radiation fin temperature rise	176		
	L5★	Output overcurrent detection	178		
	P4	Radiation fin thermistor or related abnormality	172		
	U7	Signal transmission error on outdoor unit PCB	180		

★: Displayed only when system down occurs.

5. Troubleshooting for FTX, FVXS Series

5.1 Indoor Unit PCB Abnormality

Error Code

P1

Method of Error Detection

The system checks if the circuit works properly within the microcomputer of the indoor unit.

Error Decision Conditions

The system cannot set the internal settings.

Supposed Causes

- Wrong models interconnected
- Defective indoor unit PCB
- Disconnection of connector
- Reduction of power supply voltage

Troubleshooting

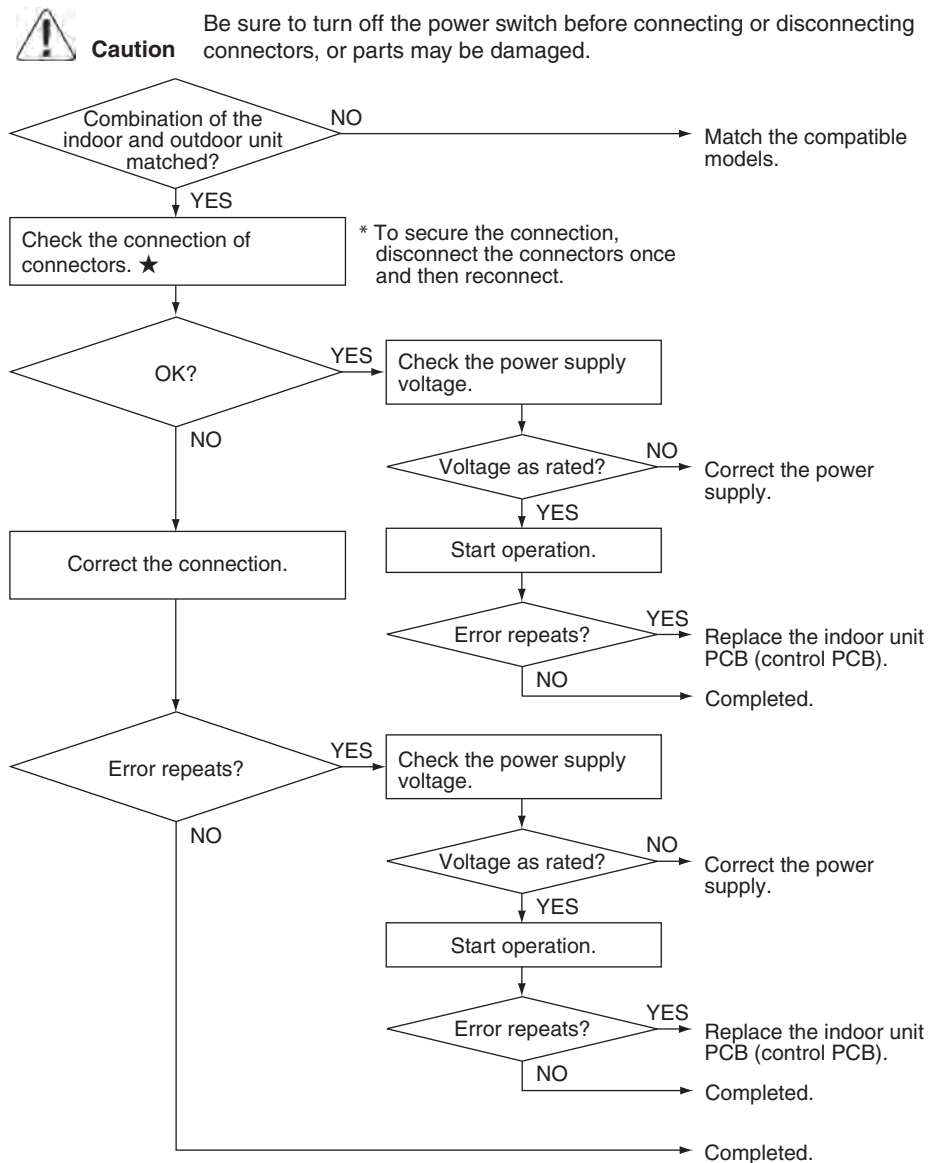

(R23407)



Note

★Connectors

FTX09/12NMVJU FTX18/24UVJU FVXS series	Terminal ~ Control PCB (H1, H2, H3)
FTX15NMVJU	Terminal ~ Filter PCB (S100) Filter PCB (S800) ~ Control PCB (S900)

5.2 Freeze-up Protection Control/Heating Peak-cut Control

Error Code	A5
Method of Error Detection	<ul style="list-style-type: none"> ■ Freeze-up protection control During cooling operation, the freeze-up protection control (operation halt) is activated according to the temperature detected by the indoor heat exchanger thermistor. ■ Heating peak-cut control During heating operation, the temperature detected by the indoor heat exchanger thermistor is used for the heating peak-cut control (operation halt, outdoor fan stop, etc.)
Error Decision Conditions	<ul style="list-style-type: none"> ■ Freeze-up protection control During cooling operation, the indoor heat exchanger temperature is below 0°C (32°F). ■ Heating peak-cut control During heating operation, the indoor heat exchanger temperature is above 59 ~ 60°C (138.2 ~ 140°F).
Supposed Causes	<ul style="list-style-type: none"> ■ Short-circuited air ■ Clogged air filter of the indoor unit ■ Dust accumulation on the indoor heat exchanger ■ Defective indoor heat exchanger thermistor ■ Defective indoor unit PCB

Troubleshooting

Caution

Be sure to turn off the power switch before connecting or disconnecting connectors, or parts may be damaged.

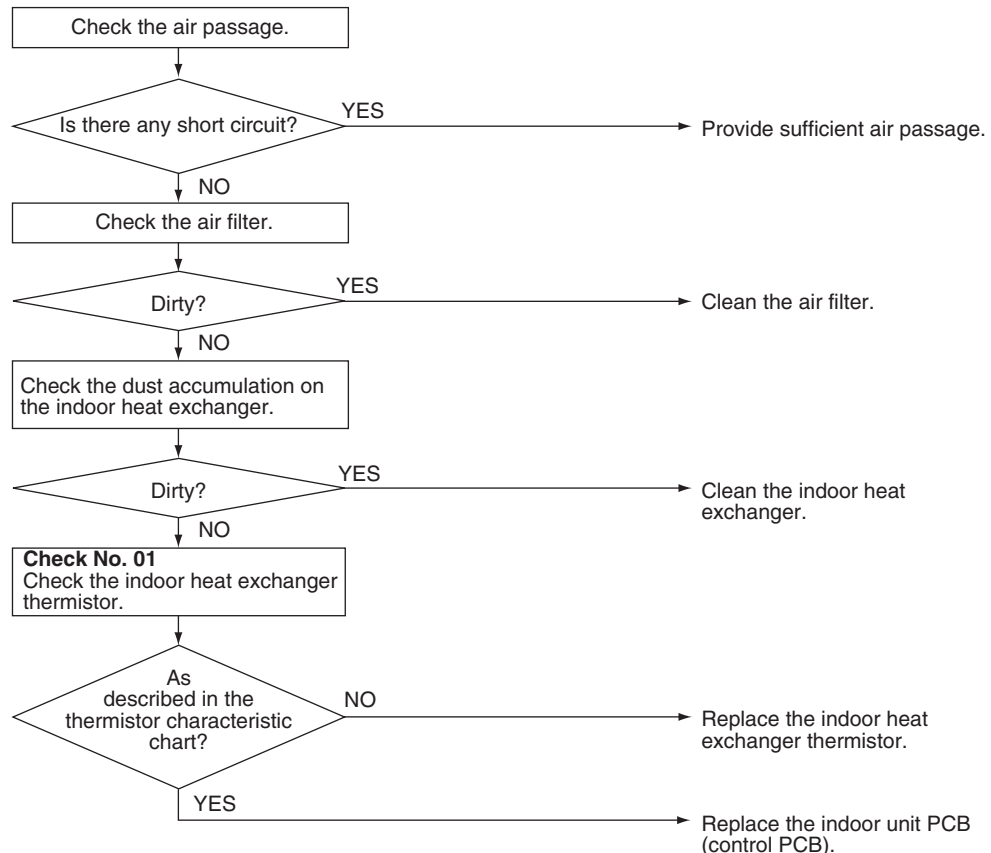

(R21064)



Reference

Check No.01 Refer to P.181

5.3 Indoor Fan Motor (DC Motor) or Related Abnormality

Error Code	F5
Method of Error Detection	The rotation speed detected by the Hall IC during indoor fan motor operation determines abnormal fan motor operation.
Error Decision Conditions	The detected rotation speed does not reach the demanded rotation speed of the target tap, and is less than 50% of the maximum fan motor rotation speed.
Supposed Causes	<ul style="list-style-type: none"> ■ Remarkable decrease in power supply voltage ■ Layer short inside the fan motor winding ■ Breaking of wire inside the fan motor ■ Breaking of the fan motor lead wires ■ Defective capacitor of the fan motor ■ Defective indoor unit PCB
Troubleshooting	FTX09/12/15NMVJU

**Caution**

Be sure to turn off the power switch before connecting or disconnecting connectors, or parts may be damaged.

Turn off the power supply.
(Unplug the power cable or turn the breaker off.)

Note: The motor may break when the motor connector is disconnected with the power supply on.
(Turn off the power supply before connecting the connector also.)

Check the connector for connection.

* To secure the connection, once disconnect the connector and then reconnect it.

OK?

NO

Correct the connection.

YES

Foreign matters in or around the fan?

YES

Remove the foreign matters.

NO

Rotate the fan by hand.



Go to the next page

(R23939)

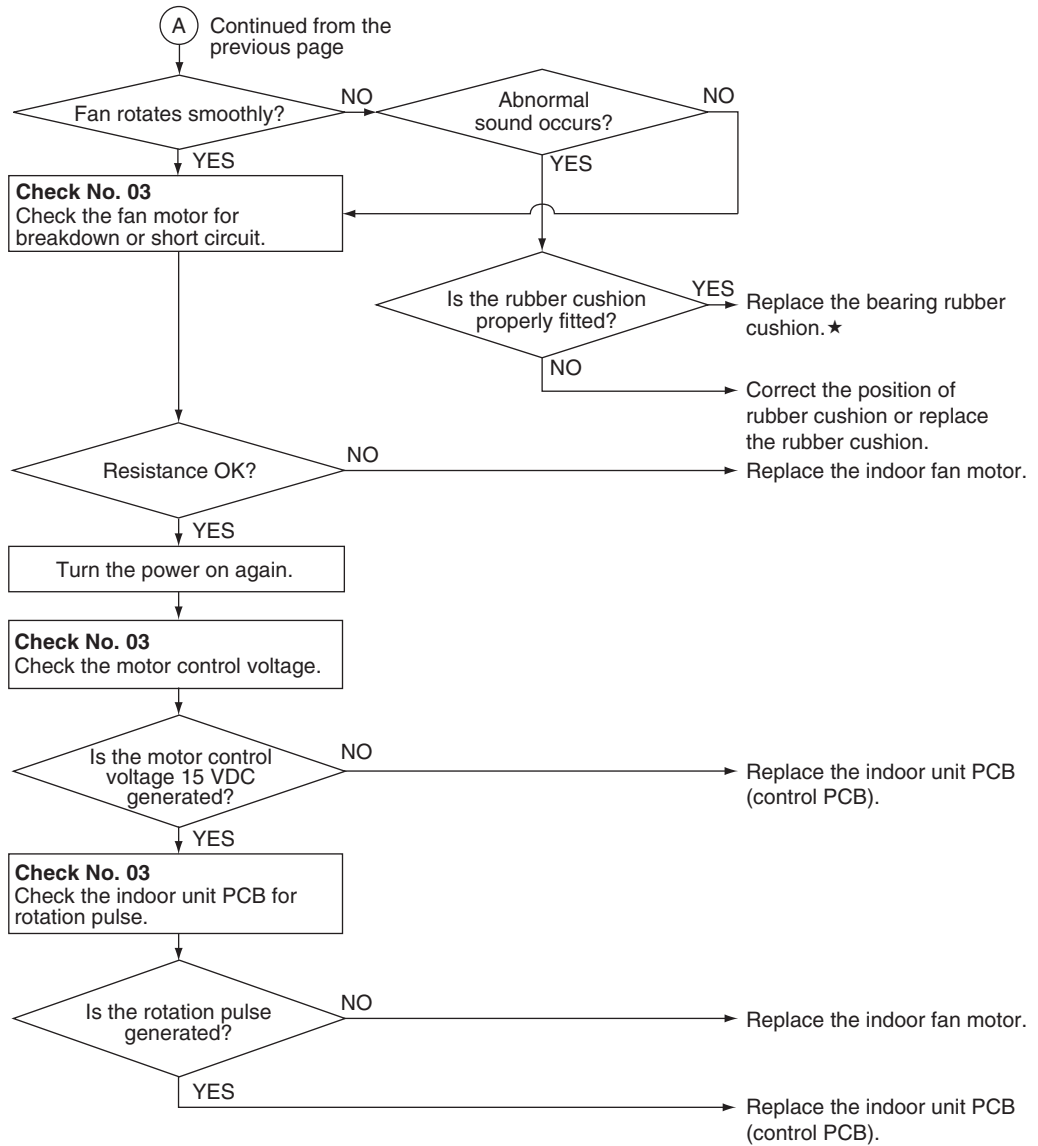

(R24945)

★Rubber cushion

09/12 class

15 class

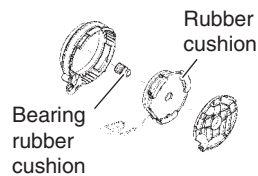

R6000673

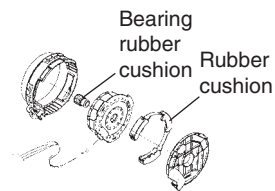

R6000674

i Note(s)

The rotation pulse is the feedback signal from the indoor fan motor.

📄 Reference

Check No.03 Refer to P.182

Troubleshooting FTX18/24UVJU, FVXS Series

Caution Be sure to turn off the power switch before connecting or disconnecting connectors, or parts may be damaged.

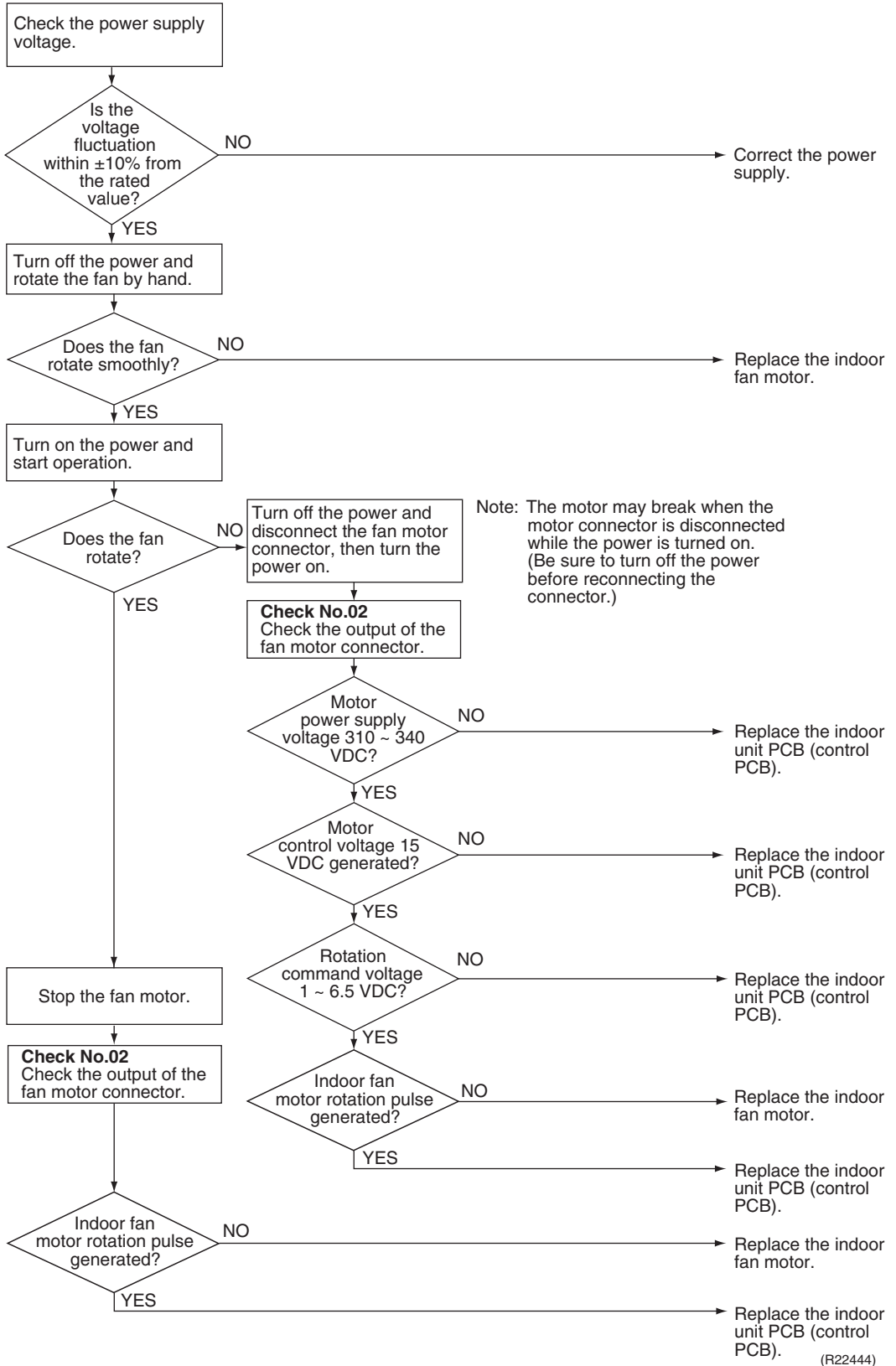



Note(s) The rotation pulse is the feedback signal from the indoor fan motor.



Reference **Check No.02** Refer to P.182

5.4 Thermistor or Related Abnormality

Error Code	£4, £9
Method of Error Detection	The temperatures detected by the thermistors determine thermistor errors.
Error Decision Conditions	The voltage between the both ends of the thermistor is either 4.96 V or more, or 0.04 V or less with the power on.
Supposed Causes	<ul style="list-style-type: none"> ■ Disconnection of connector ■ Defective thermistor(s) ■ Defective indoor unit PCB

Troubleshooting

Caution

Be sure to turn off the power switch before connecting or disconnecting connectors, or parts may be damaged.

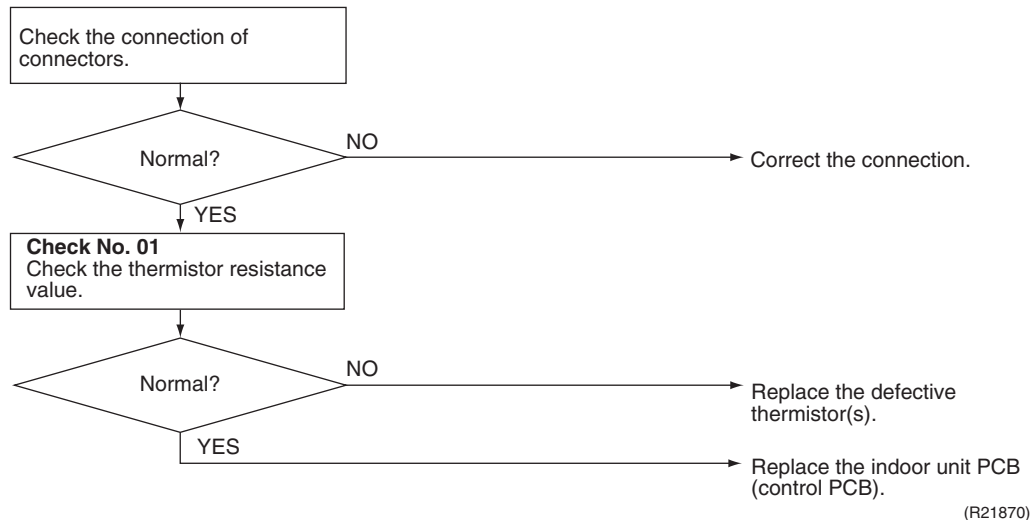

(R21870)

£4 : Indoor heat exchanger thermistor

£9 : Room temperature thermistor



Reference

Check No.01 Refer to P.181

5.5 Low-voltage Detection or Over-voltage Detection

Error Code	U2
Method of Error Detection	<p>Low-voltage detection: An abnormal voltage drop is detected by the DC voltage detection circuit.</p> <p>Over-voltage detection: An abnormal voltage rise is detected by the over-voltage detection circuit.</p>
Error Decision Conditions	<p>Low-voltage detection:</p> <ul style="list-style-type: none"> ■ The voltage detected by the DC voltage detection circuit is below 150 ~ 200 V (depending on the model). ■ The compressor stops if the error occurs, and restarts automatically after 3-minute standby. <p>Over-voltage detection:</p> <ul style="list-style-type: none"> ■ An over-voltage signal is fed from the over-voltage detection circuit to the microcomputer (over 458 ~ 500 V, depending on the model). ■ The compressor stops if the error occurs, and restarts automatically after 3-minute standby.
Supposed Causes	<ul style="list-style-type: none"> ■ Power supply voltage out of specification ■ Defective DC voltage detection circuit ■ Defective over-voltage detection circuit ■ Defective PAM control part ■ Disconnection of compressor harness ■ Short circuit inside the fan motor winding ■ Noise ■ Momentary drop of voltage ■ Momentary power failure ■ Defective outdoor unit PCB

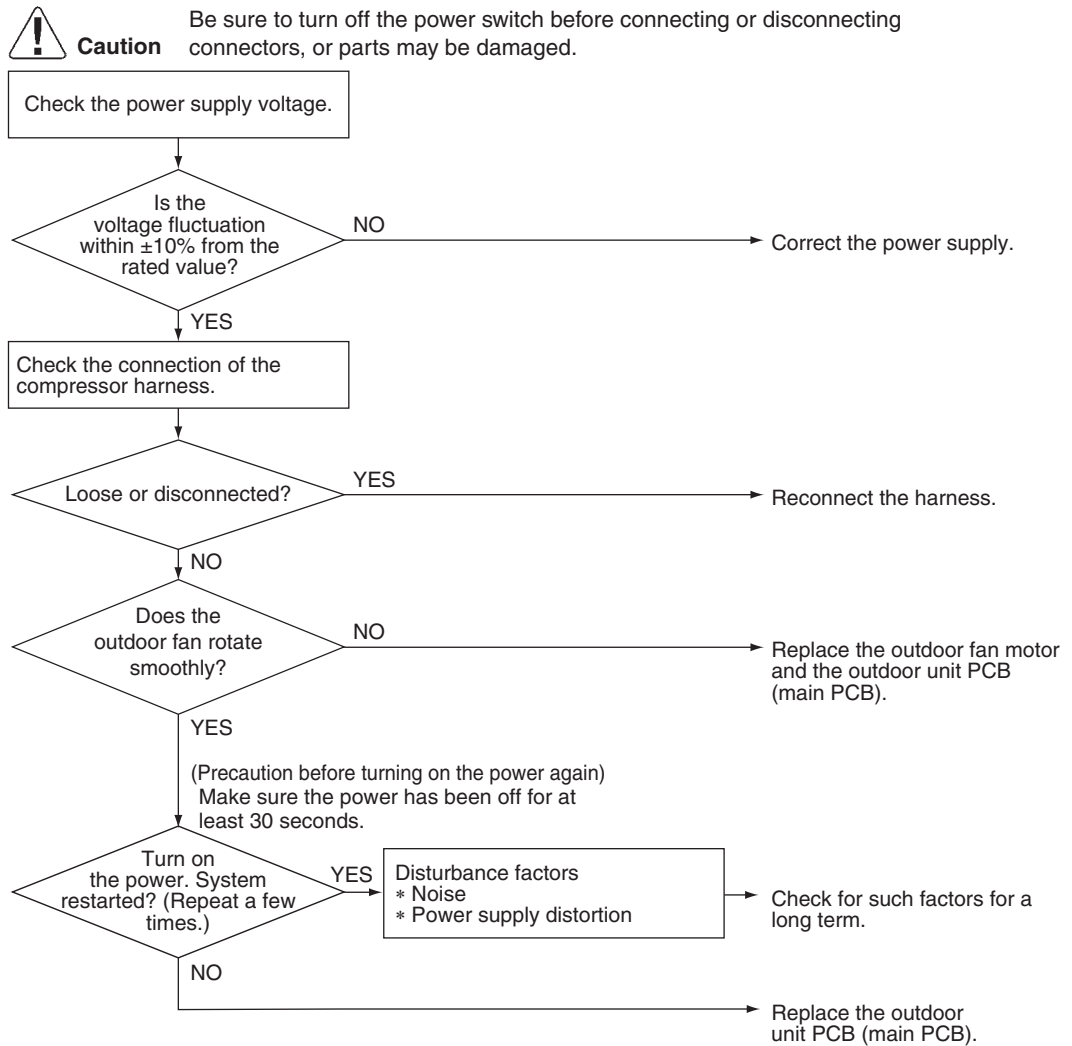
Troubleshooting



(R22445)

5.6 Signal Transmission Error (Between Indoor Unit and Outdoor Unit)

Error Code	U4
Method of Error Detection	The signal transmission data received from the outdoor unit is checked whether it is normal.
Error Decision Conditions	The data sent from the outdoor unit cannot be received normally, or the content of the data is abnormal.
Supposed Causes	<ul style="list-style-type: none"> ■ Power supply voltage not as specified ■ Reduction of power supply voltage ■ Wiring error ■ Breaking of the connection wires between the indoor and outdoor units (wire No. 3) ■ Defective outdoor unit PCB ■ Short circuit inside the fan motor winding ■ Defective indoor unit PCB ■ Disturbed power supply waveform

Troubleshooting

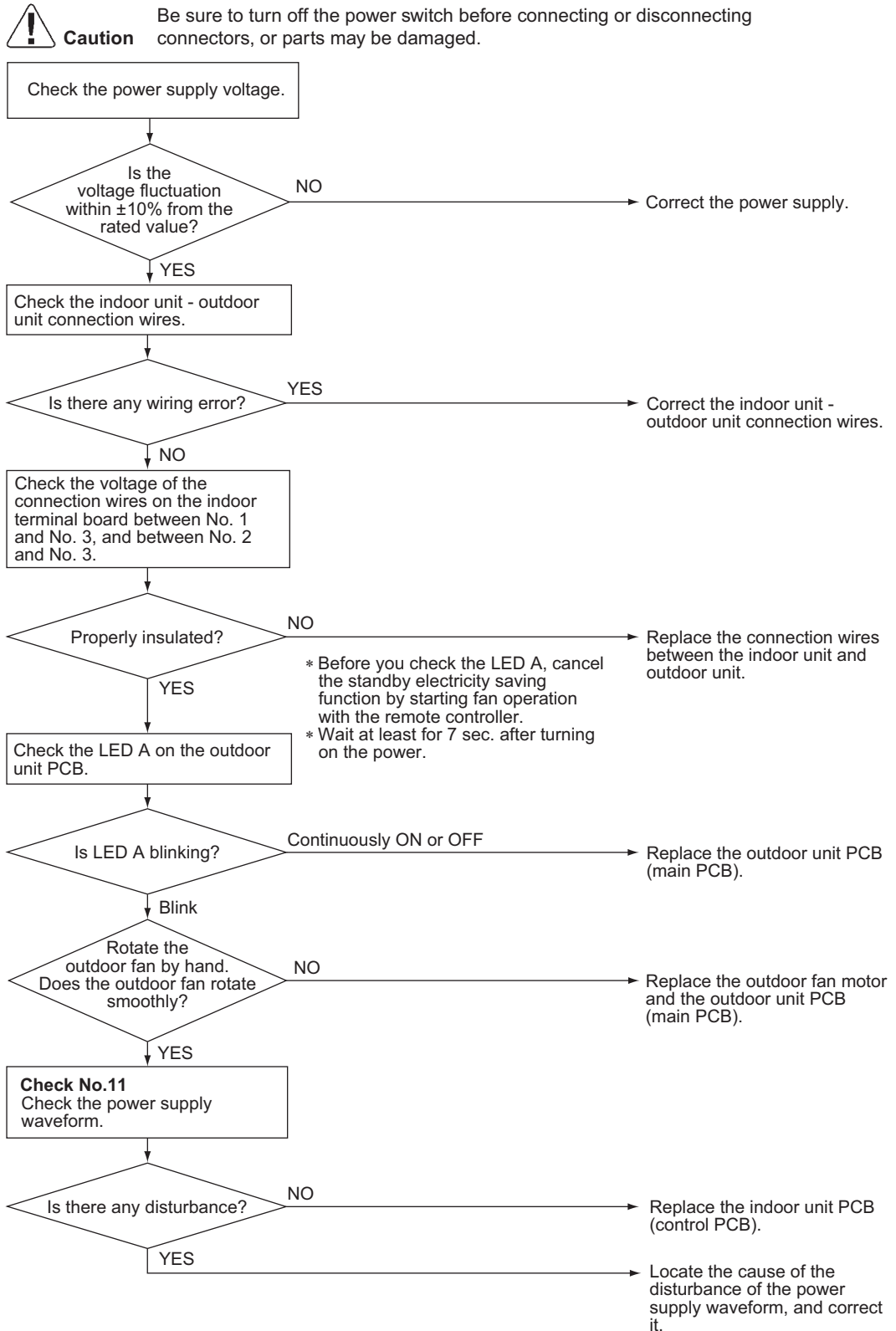

(R21189)



Reference

Check No.11 Refer to P.184

5.7 Unspecified Voltage (Between Indoor Unit and Outdoor Unit)

Error Code



Method of Error Detection

The supply power is detected for its requirements (pair type is different from multi type) by the indoor/outdoor transmission signal.

Error Decision Conditions

The pair type and multi type are interconnected.

Supposed Causes

- Wrong models interconnected
- Wrong wiring of connecting wires
- Wrong indoor unit PCB or outdoor unit PCB mounted
- Defective indoor unit PCB
- Defective outdoor unit PCB

Troubleshooting



Caution Be sure to turn off the power switch before connecting or disconnecting connectors, or parts may be damaged.

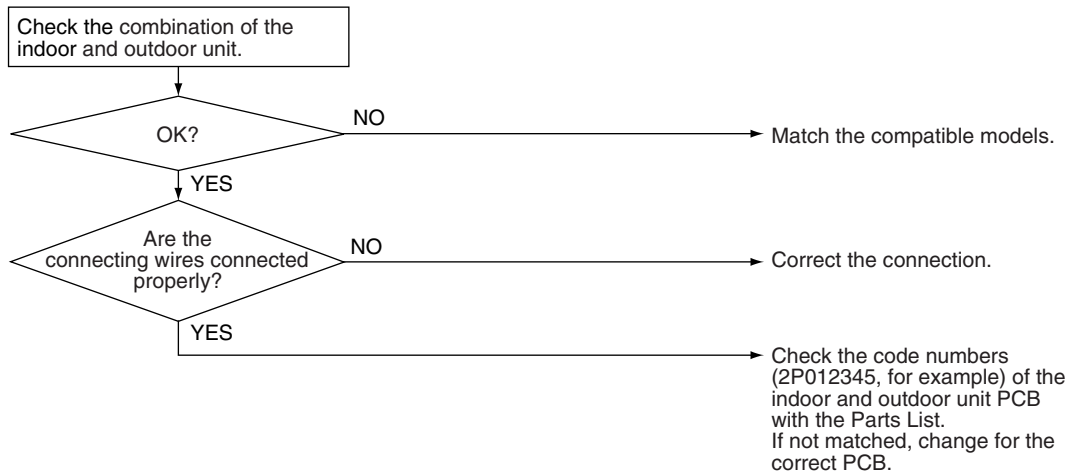

(R20435)

6. Troubleshooting for FDMQ Series

6.1 Indoor Unit PCB Abnormality

Error Code	R1
Method of Error Detection	The system checks the data from EEPROM.
Error Decision Conditions	When the data from the EEPROM is not received correctly EEPROM (Electrically Erasable Programmable Read Only Memory): A memory chip that holds its content without power. It can be erased, either within the computer or externally and usually requires more voltage for erasure than the common +5 volts used in logic circuits. It functions like non-volatile RAM, but writing to EEPROM is slower than writing to RAM.
Supposed Causes	<ul style="list-style-type: none"> ■ Defective indoor unit PCB ■ External factor (noise etc.)

Troubleshooting

Caution

Be sure to turn off the power switch before connecting or disconnecting connectors, or parts may be damaged.

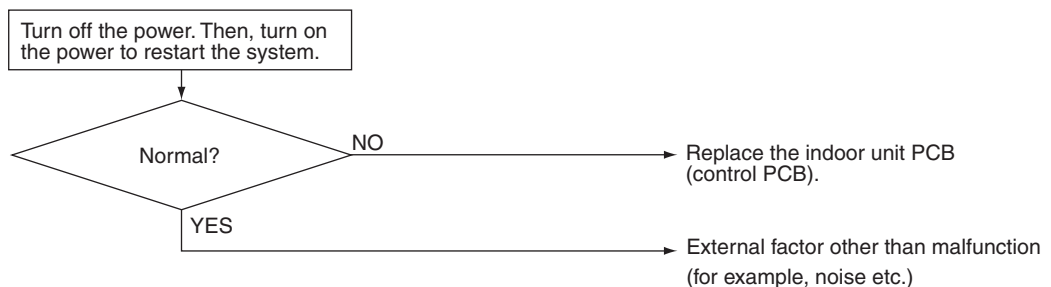

(R22247)

6.2 Drain Level Control System Abnormality

Error Code	A3
Method of Error Detection	The float switch detects error.
Error Decision Conditions	When the water level reaches its upper limit and when the float switch turns OFF
Supposed Causes	<ul style="list-style-type: none"> ■ Defective drain pump ■ Improper drain piping work ■ Clogged drain piping ■ Defective float switch ■ Defective indoor unit PCB ■ Defective short circuit connector X15A, X25A on indoor unit PCB

Troubleshooting

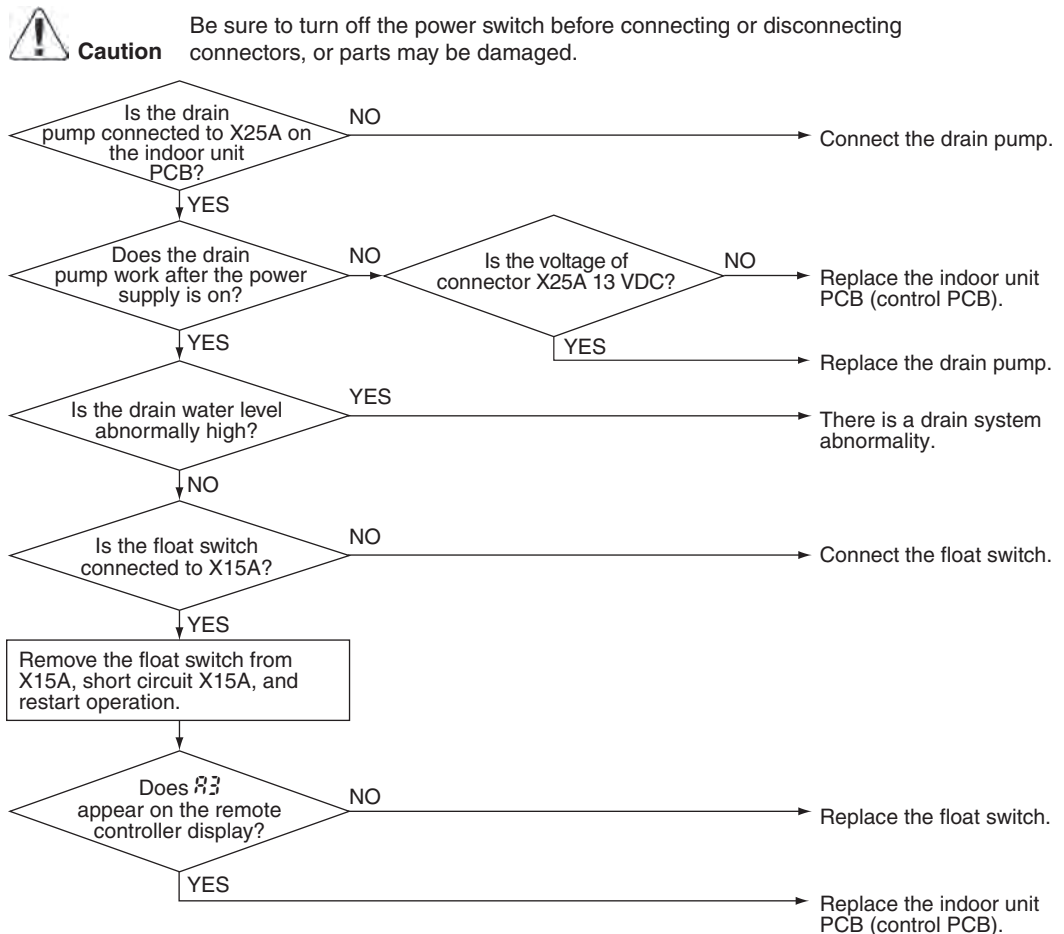

(R25079)

6.3 Indoor Fan Motor (DC Motor) or Related Abnormality

Error Code	F5
Method of Error Detection	<ul style="list-style-type: none"> ■ Detection from the current flow on the fan PCB ■ Detection from the rotation speed of the fan motor in operation
Error Decision Conditions	The rotation speed is less than a certain level for 6 seconds.
Supposed Causes	<ul style="list-style-type: none"> ■ Clogged foreign matter ■ Disconnection of fan motor connectors ■ Disconnection of the connector between the indoor unit PCB and the fan PCB ■ Defective fan PCB ■ Defective fan motor ■ No fuse continuity

Trouble Shooting

Caution

Be sure to turn off the power switch before connecting or disconnecting connectors, or parts may be damaged.

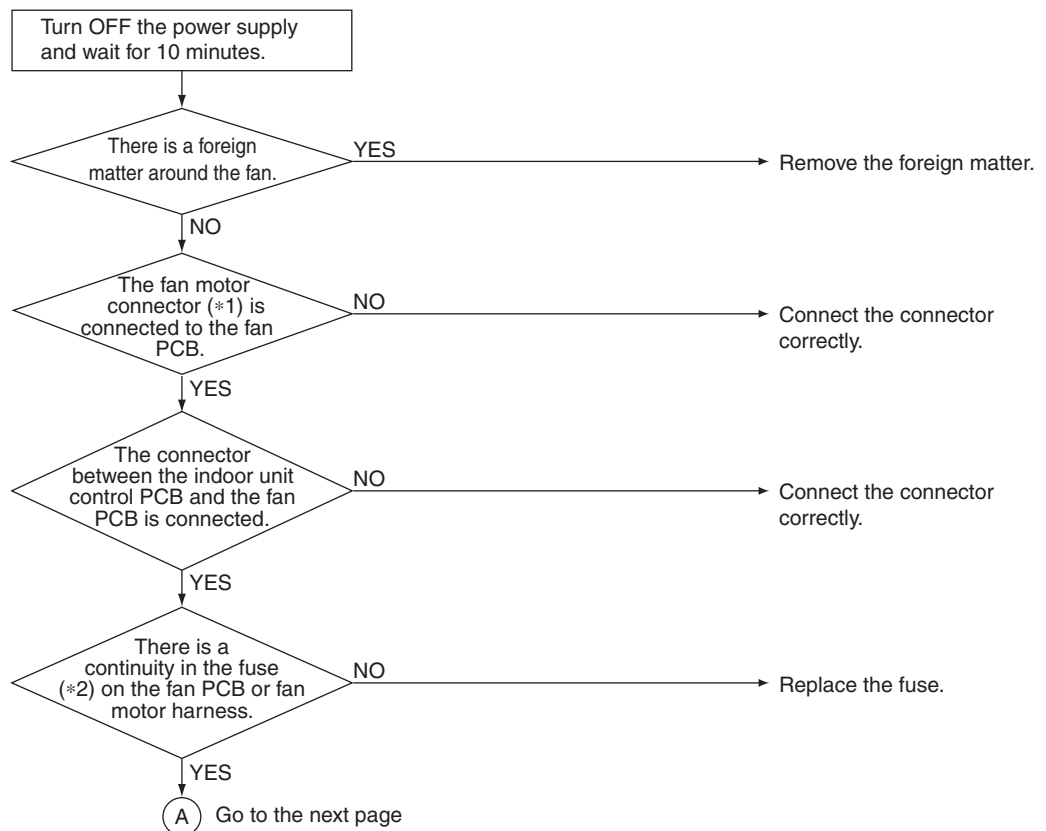

R6000547

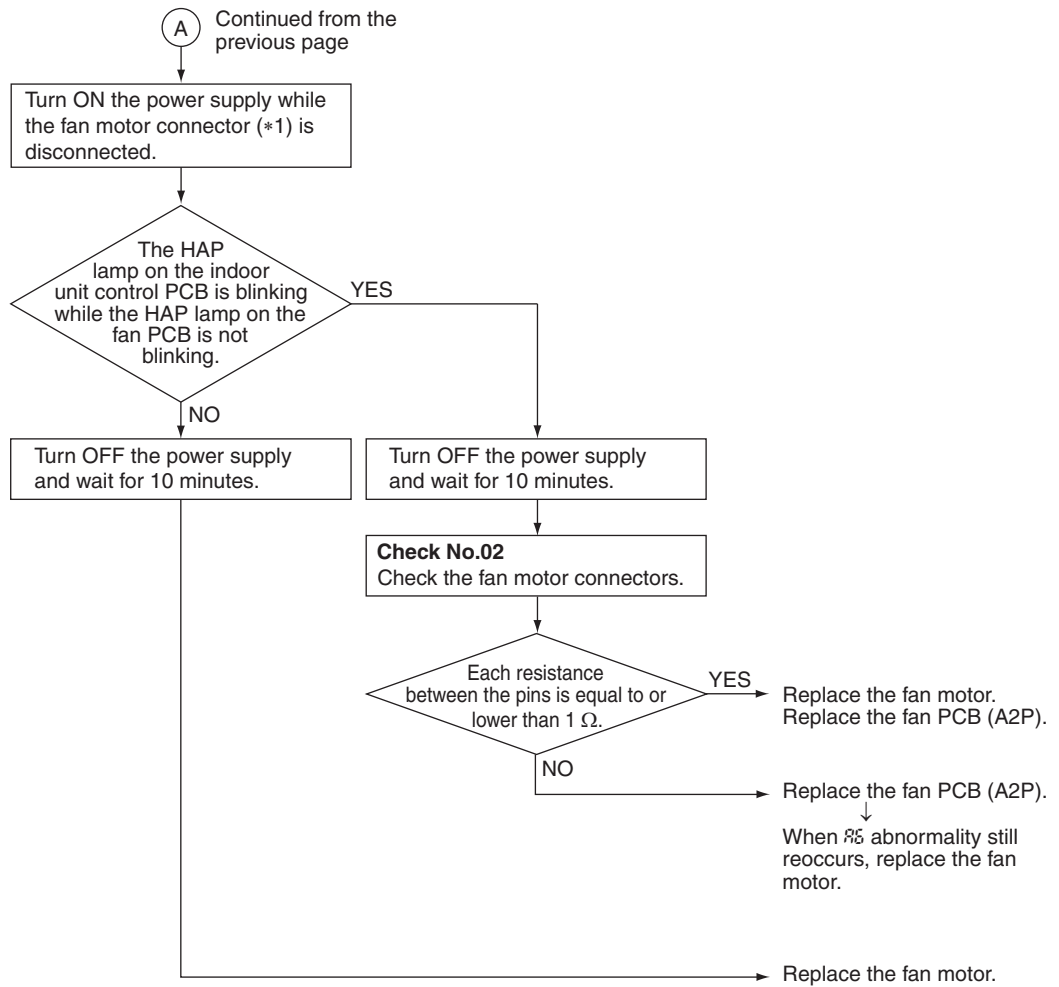

R6000548

i Note

Connector and indoor unit PCB

Model	*1 Fan motor connector	*2 Fuse
FDMQ Series	X8A	F2U

📄 Reference

Check No.02 Refer to P.182

6.4 Indoor Fan PCB Abnormality

Error Code



Method of Error Detection

Microcomputer checks the voltage state of the fan PCB.

Error Decision Conditions

Overvoltage or voltage drop is detected on the fan PCB.

Supposed Causes

- Defective fan PCB
- External factor such as noise

Troubleshooting



Caution Be sure to turn off the power switch before connecting or disconnecting connectors, or parts may be damaged.

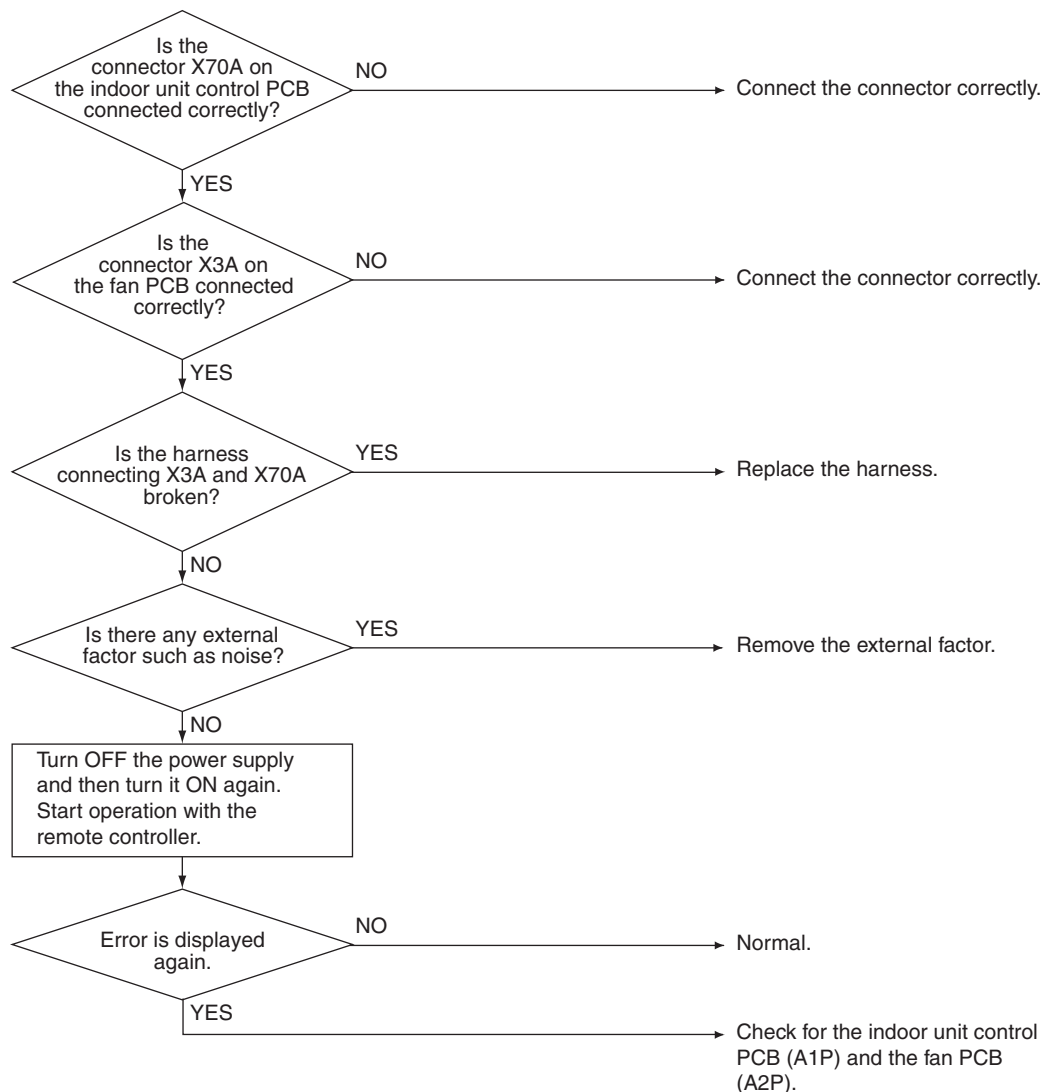

R6000549

6.5 Humidifier or Related Abnormality

Error Code	F5
Method of Error Detection	Water leakage from humidifier(s) is detected based on the float switch ON/OFF changeover while the system is not operating.
Error Decision Conditions	The float switch changes from ON to OFF while the system is OFF
Supposed Causes	<ul style="list-style-type: none"> ■ Defective float switch ■ Error in water drain system of humidifier(s) ■ Clogged electric expansion valve in humidifier(s) ■ Defective indoor unit PCB

Troubleshooting



Caution Be sure to turn off the power switch before connecting or disconnecting connectors, or parts may be damaged.

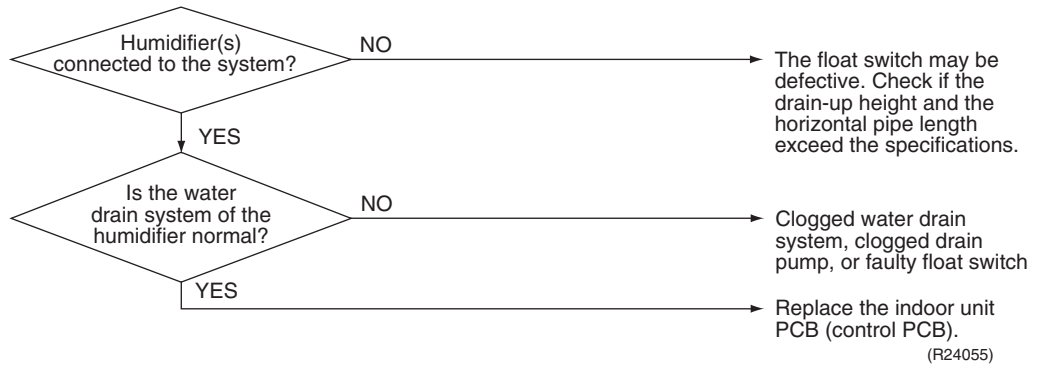

Note

The system continues to operate with the thermostat OFF even while the error code is displayed.

6.6 Thermistor or Related Abnormality

Error Code	£4, £5, £9
Method of Error Detection	The temperatures detected by the thermistors determine thermistor errors.
Error Decision Conditions	The thermistor is disconnected or shorted while the unit is running.
Supposed Causes	<ul style="list-style-type: none"> ■ Disconnection of connector ■ Defective thermistor(s) ■ Breaking of wires ■ Defective indoor unit PCB
Troubleshooting	<p>If the cause of the problem is related to the thermistors, the thermistors should be checked prior to changing the indoor unit PCB.</p> <p>To check the thermistors, proceed as follows:</p> <ol style="list-style-type: none"> 1. Disconnect the thermistor from the indoor unit PCB. 2. Read the temperature and the resistance value. 3. Check if the measured values correspond with the values in the table of thermistor resistance check.

Caution

Be sure to turn off the power switch before connecting or disconnecting connectors, or parts may be damaged.

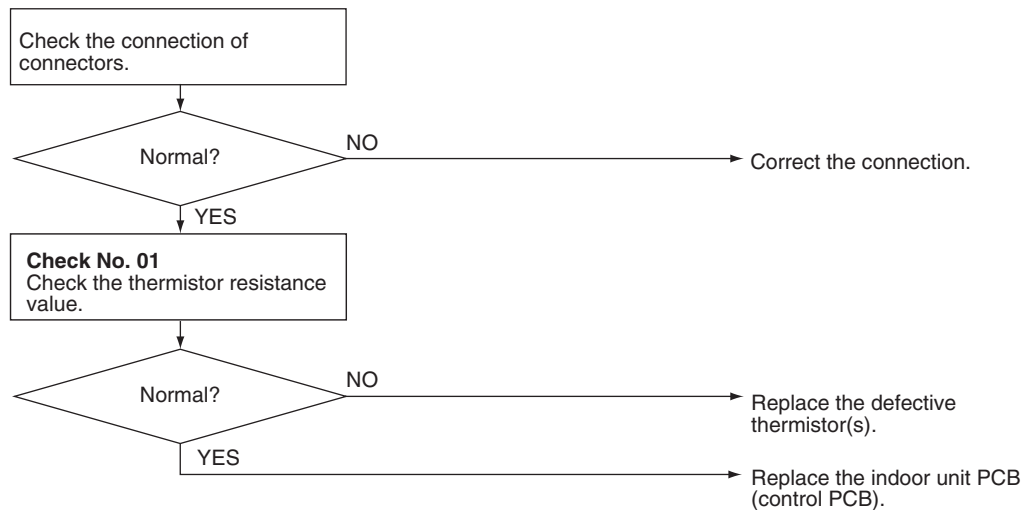

(R24056)

£4: Indoor heat exchanger thermistor 1 (liquid pipe) (R2T)

£5: Indoor heat exchanger thermistor 2 (R3T)

£9: Room temperature thermistor (R1T)



Reference

Check No.01 Refer to P.181

6.7 Remote Controller Thermistor Abnormality

Error Code	
Method of Error Detection	Even if remote controller thermistor is faulty, system is possible to operate by system thermistor. Malfunction detection is carried out by the temperature detected by the remote controller thermistor.
Error Decision Conditions	The remote controller thermistor is disconnected or shorted while the unit is running.
Supposed Causes	<ul style="list-style-type: none"> ■ Defective room temperature thermistor in the wired remote controller ■ Defective wired remote controller PCB ■ External factor such as noise

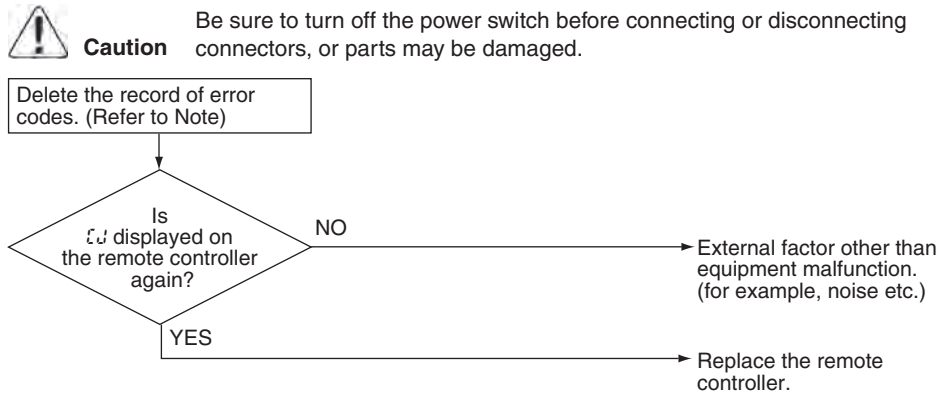
Troubleshooting



Note

To delete the record of error codes, press **ON/OFF** button on the remote controller for 4 seconds or more while the error code is displayed in the inspection mode.

6.8 Low-voltage Detection or Over-voltage Detection

Error Code	U2
Method of Error Detection	<p>Low-voltage detection: An abnormal voltage drop is detected by the DC voltage detection circuit.</p> <p>Over-voltage detection: An abnormal voltage rise is detected by the over-voltage detection circuit.</p>
Error Decision Conditions	<p>Low-voltage detection:</p> <ul style="list-style-type: none"> ■ The voltage detected by the DC voltage detection circuit is below 150 ~ 200 V (depending on the model). ■ The compressor stops if the error occurs, and restarts automatically after 3-minute standby. <p>Over-voltage detection:</p> <ul style="list-style-type: none"> ■ An over-voltage signal is fed from the over-voltage detection circuit to the microcomputer (over 458 ~ 500 V, depending on the model). ■ The compressor stops if the error occurs, and restarts automatically after 3-minute standby.
Supposed Causes	<ul style="list-style-type: none"> ■ Power supply voltage out of specification ■ Defective DC voltage detection circuit ■ Defective over-voltage detection circuit ■ Defective PAM control part ■ Disconnection of compressor harness ■ Short circuit inside the fan motor winding ■ Noise ■ Momentary drop of voltage ■ Momentary power failure ■ Defective outdoor unit PCB

Troubleshooting

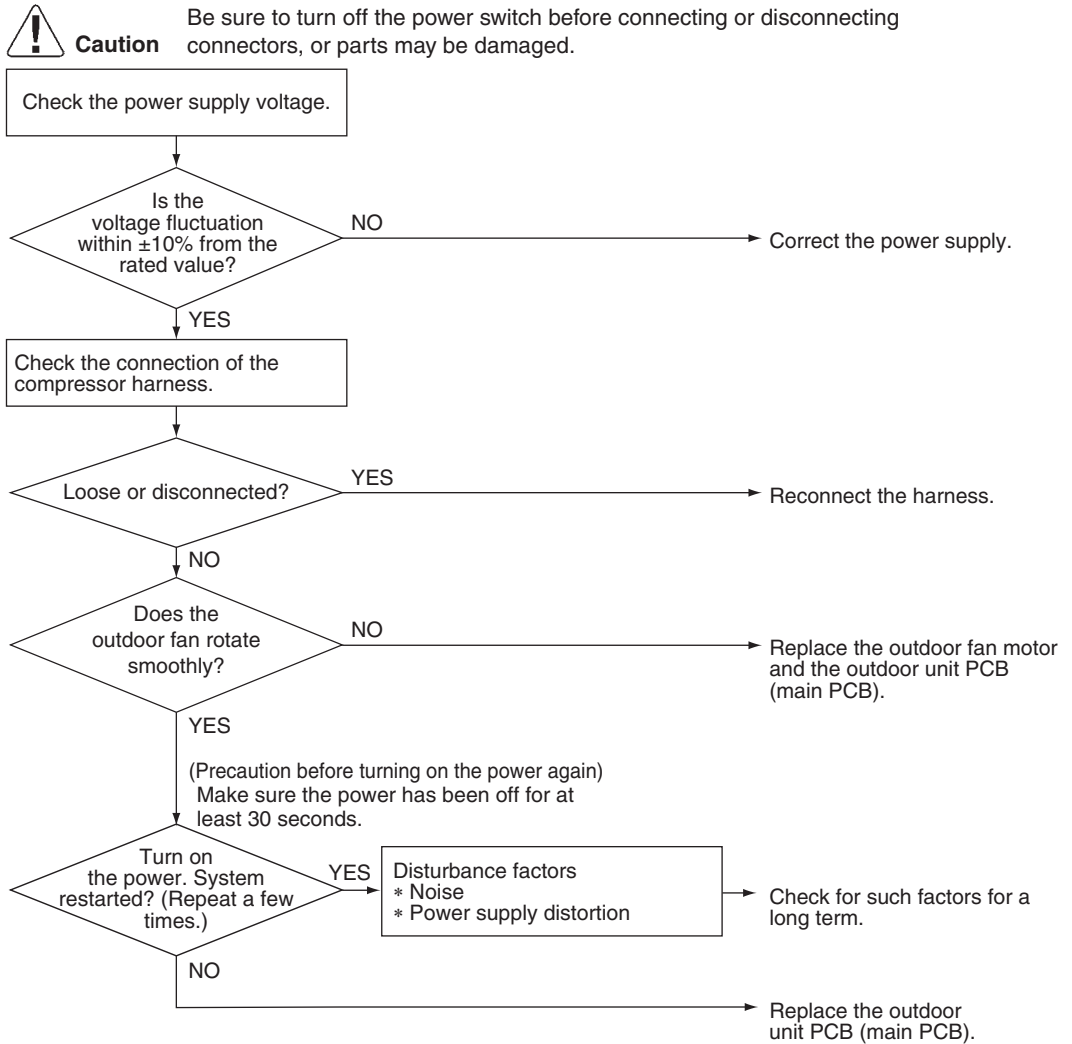

(R22445)

6.9 Signal Transmission Error (Between Indoor and Outdoor Unit)

Error Code	U4
Method of Error Detection	The signal transmission data from the outdoor unit is checked whether it is normal.
Error Decision Conditions	The data sent from the outdoor unit cannot be received normally, or the content of the data is abnormal.
Supposed Causes	<ul style="list-style-type: none">■ Power supply voltage out of specification■ Reduction of power supply voltage■ Wiring error■ Breaking of the connection wires between the indoor and outdoor units (wire No. 3)■ Defective outdoor unit PCB■ Short circuit inside the fan motor winding■ Defective indoor unit PCB■ Disturbed power supply waveform

Troubleshooting



Caution Be sure to turn off the power switch before connecting or disconnecting connectors, or parts may be damaged.

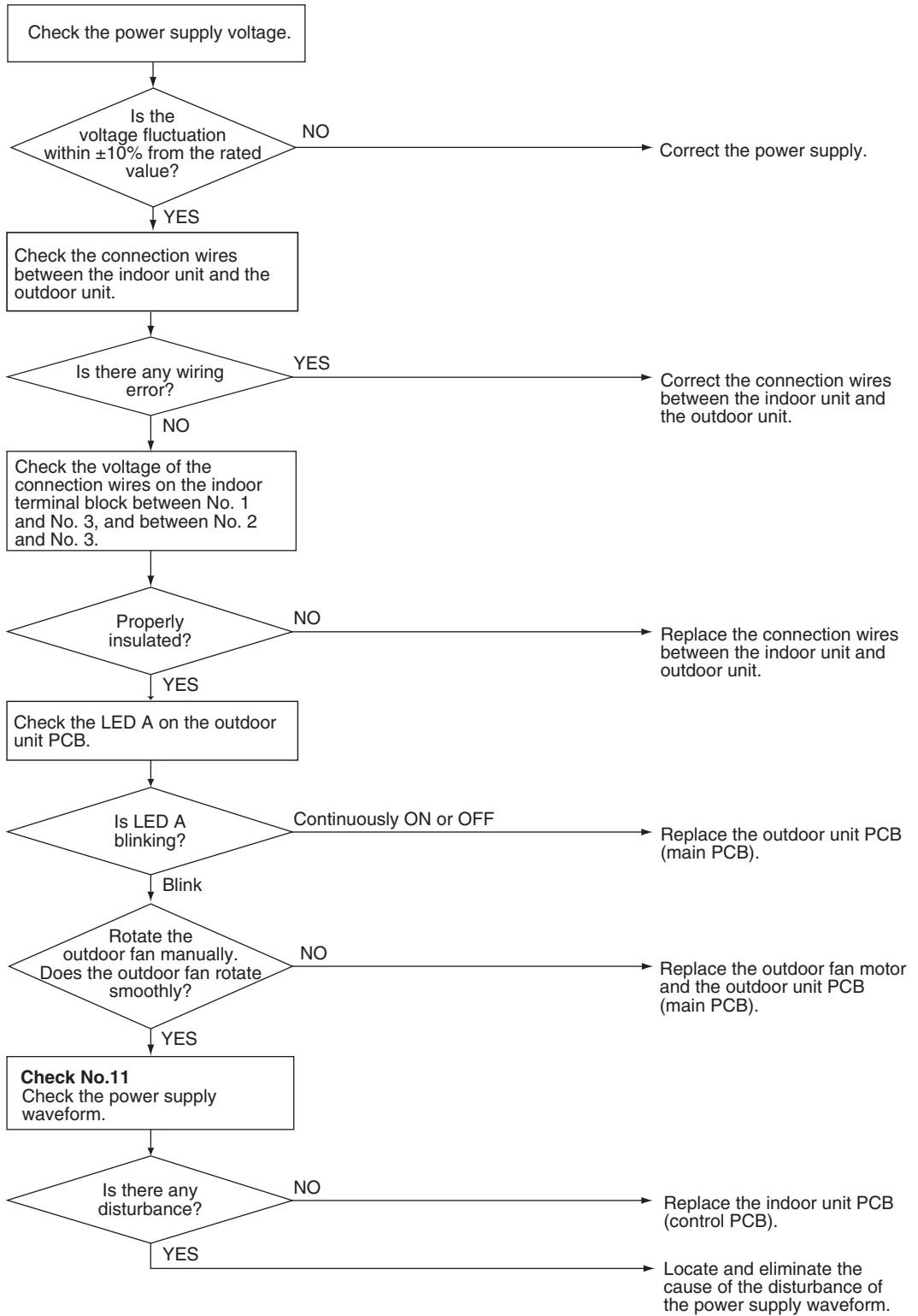

(R24622)



Reference Check No.11 Refer to P.184

6.10 Signal Transmission Error (Between Indoor Unit and Remote Controller)

Error Code	U5
Method of Error Detection	In case of controlling 1 indoor unit with 2 remote controllers, check the system using microcomputer if signal transmission between indoor unit and remote controller (main and sub) is normal.
Error Decision Conditions	Normal transmission does not continue for specified period.
Supposed Causes	<ul style="list-style-type: none"> ■ Connection of 2 main remote controllers (when using 2 remote controllers) ■ Defective indoor unit PCB ■ Defective remote controller ■ Transmission error caused by noise

Troubleshooting

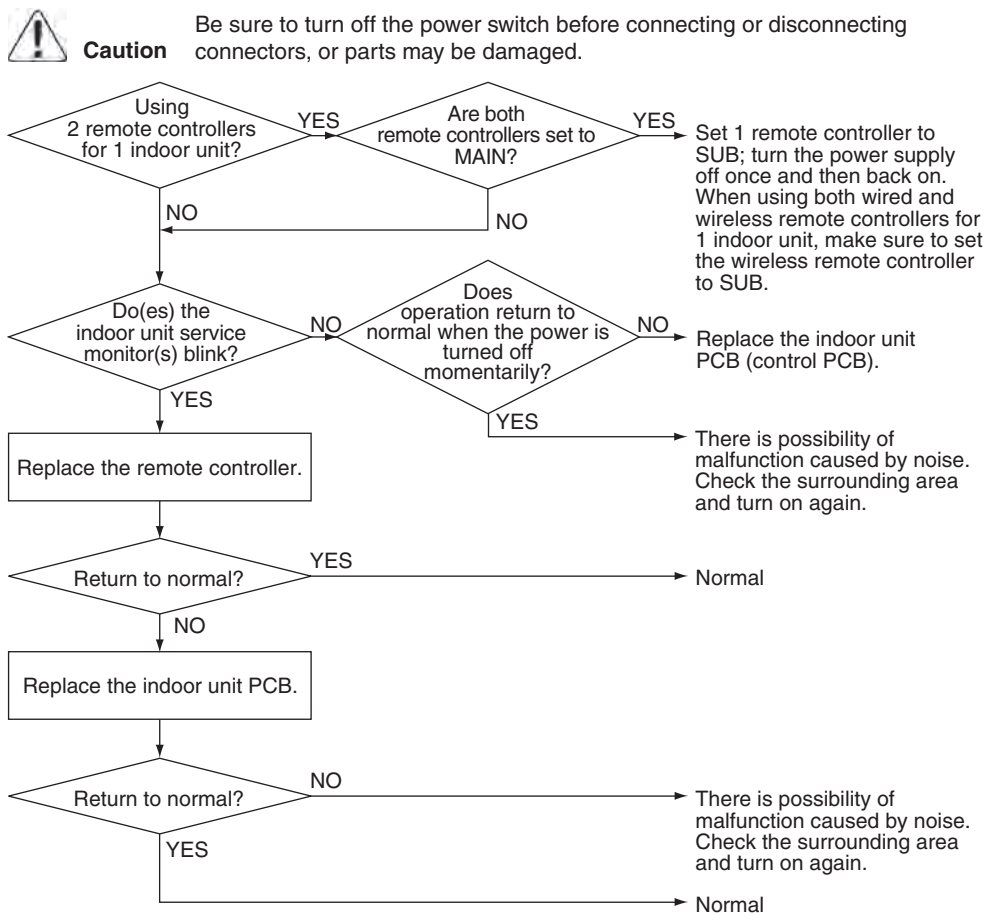

(R24590)



Note

For the way to change MAIN/SUB setting of remote controllers, refer to pages 214.

6.11 Signal Transmission Error (Between MAIN/SUB Remote Controllers)

Error Code	U8
Method of Error Detection	In case of controlling 1 indoor unit with 2 remote controllers, check the system using microcomputer if signal transmission between MAIN remote controller and SUB remote controller is normal.
Error Decision Conditions	Normal transmission does not continue for specified period.
Supposed Causes	<ul style="list-style-type: none"> ■ Remote controller is set to SUB when using 1 remote controller ■ Connection of 2 SUB remote controllers (when using 2 remote controllers) ■ Defective remote controller PCB

Troubleshooting

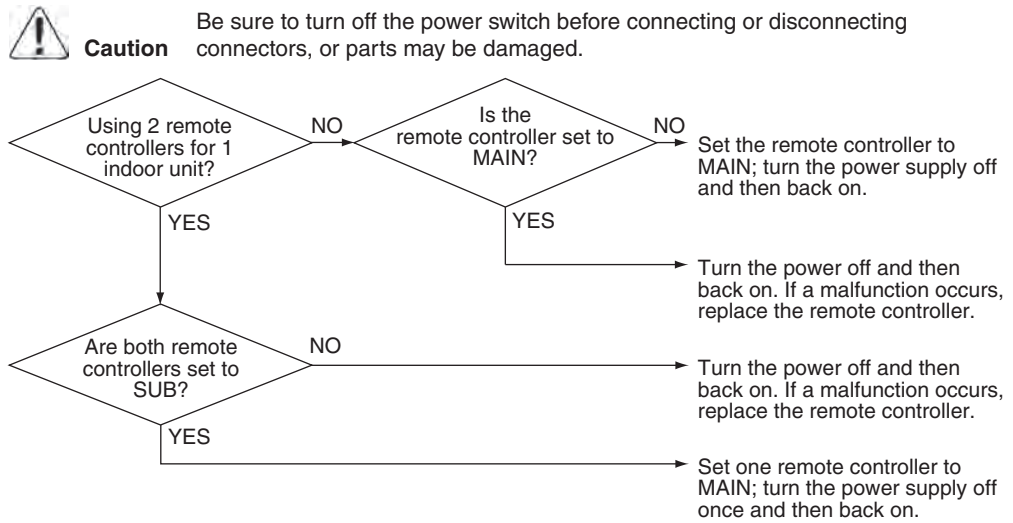

(R24058)



Note

For the way to change MAIN/SUB setting of remote controllers, refer to pages 214.

6.12 Mismatching of Indoor Unit and Outdoor Unit

Error Code	U9
Error Decision Conditions	Improper combination of indoor and outdoor units
Supposed Causes	<ul style="list-style-type: none"> ■ Defective indoor unit PCB ■ Indoor-outdoor unit transmission wiring error ■ Defective optional unit(s) wirings ■ Improper power supply wiring of indoor unit ■ Improper wiring of connecting wires between indoor/outdoor units

Troubleshooting



Caution

Be sure to turn off the power switch before connecting or disconnecting connectors, or parts may be damaged.

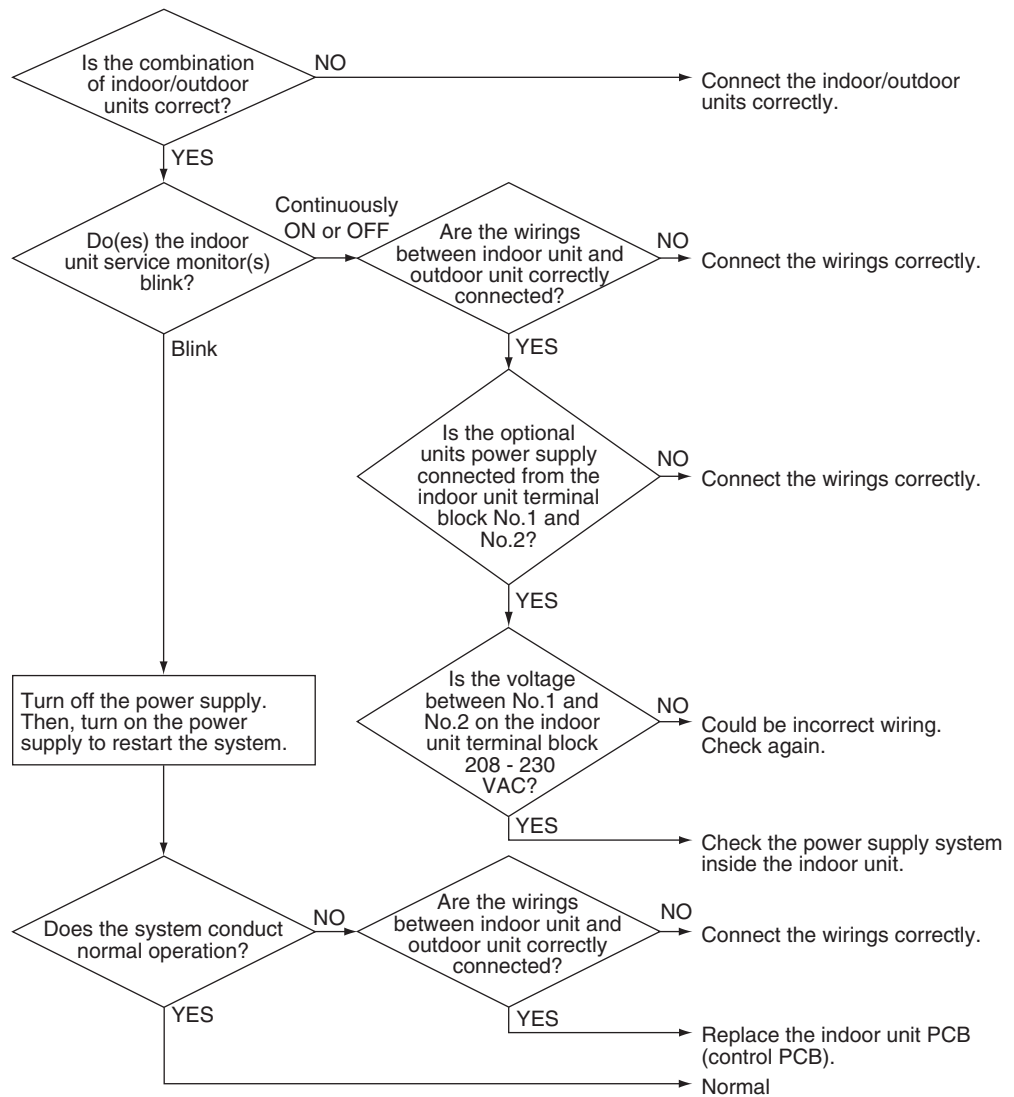

(R24591)

7. Troubleshooting for Outdoor Unit

7.1 Outdoor Unit PCB Abnormality

Error Code	E1
Method of Error Detection	<ul style="list-style-type: none"> ■ The system checks if the microprocessor is working in order. ■ The system checks if the zero-cross signal comes in properly.
Error Decision Conditions	<ul style="list-style-type: none"> ■ The microprocessor program runs out of control. ■ The zero-cross signal is not detected.
Supposed Causes	<ul style="list-style-type: none"> ■ Defective outdoor unit PCB ■ Noise ■ Momentary drop of voltage ■ Momentary power failure

Troubleshooting

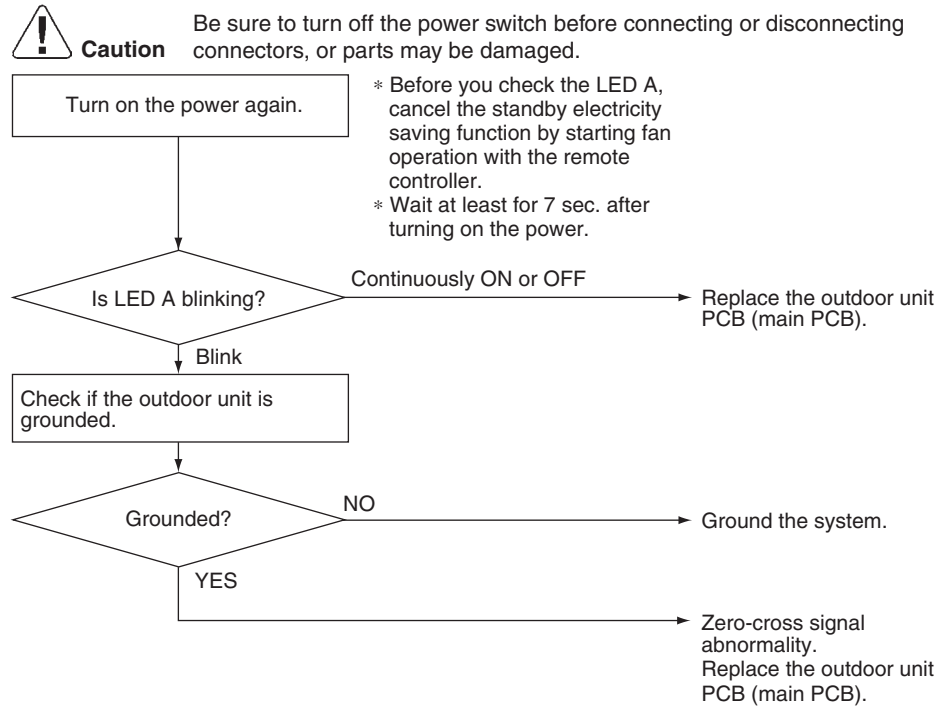

(R21201)

7.2 OL Activation (Compressor Overload)

Error Code	E5
Method of Error Detection	A compressor overload is detected through compressor OL.
Error Decision Conditions	<ul style="list-style-type: none">■ If the error repeats, the system is shut down.■ Reset condition: Continuous run for about 60 minutes without any other error
Supposed Causes	<ul style="list-style-type: none">■ Disconnection of discharge pipe thermistor■ Defective discharge pipe thermistor■ Disconnection of connector S40■ Disconnection of 2 terminals of OL (Q1L)■ Defective OL (Q1L)■ Broken OL harness■ Defective electronic expansion valve or coil■ Defective four way valve or coil■ Defective outdoor unit PCB■ Refrigerant shortage■ Water mixed in refrigerant■ Defective stop valve

Troubleshooting



Caution Be sure to turn off the power switch before connecting or disconnecting connectors, or parts may be damaged.

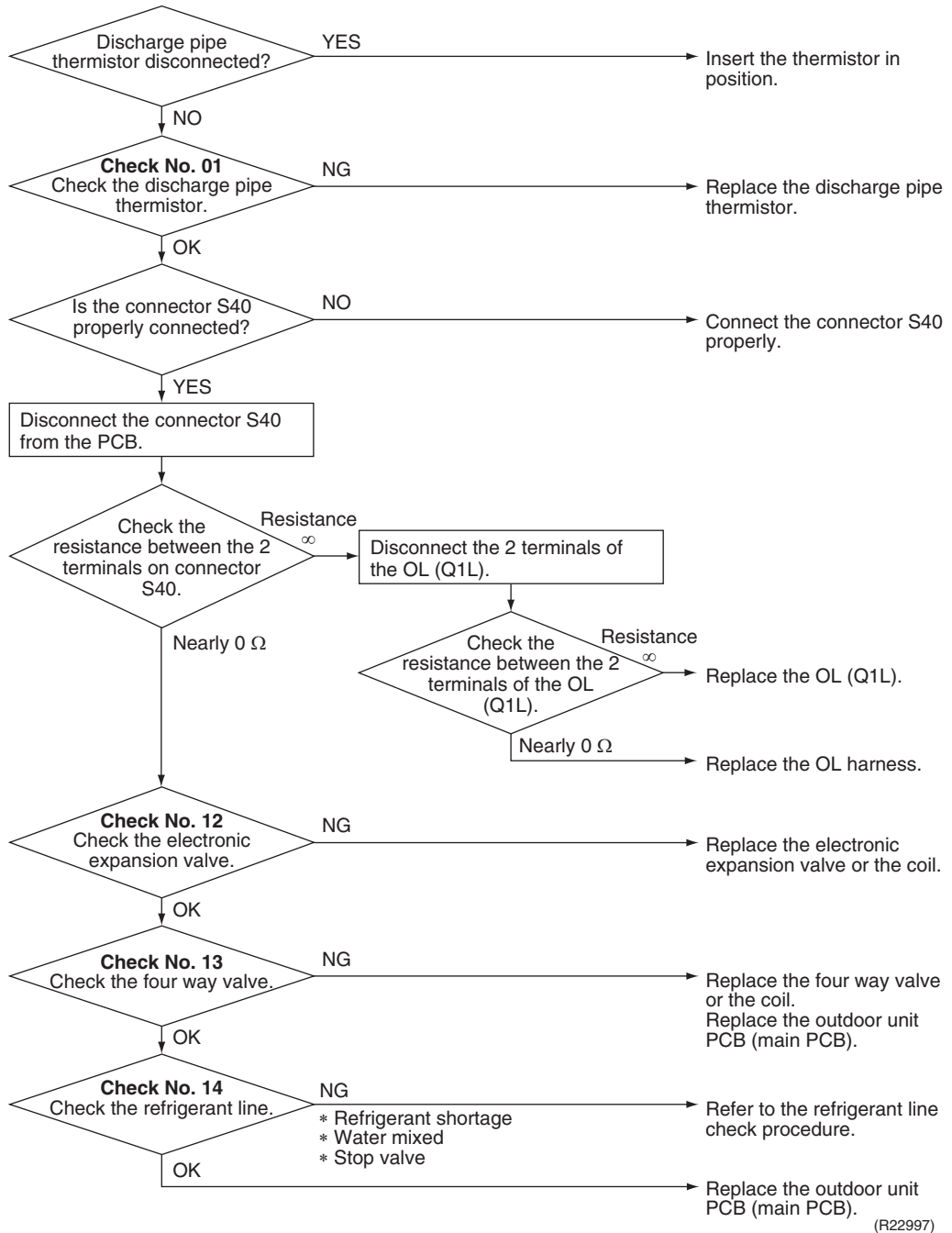

Note

OL (Q1L) activating temperature: 120 ~ 130°C (248 ~ 266°F)
 OL (Q1L) recovery temperature: 95°C (203°F)



Reference

Check No.01 Refer to P.181



Reference

Check No.12 Refer to P.184



Reference

Check No.13 Refer to P.185



Reference

Check No.14 Refer to P.185

7.3 Compressor Lock

Error Code	E6
Method of Error Detection	A compressor lock is detected by the current waveform generated when applying high-frequency voltage to the motor.
Error Decision Conditions	<ul style="list-style-type: none"> ■ If the error repeats, the system is shut down. ■ Reset condition: Continuous run for about 11 minutes without any other error
Supposed Causes	<ul style="list-style-type: none"> ■ Closed stop valve ■ Compressor locked ■ Disconnection of compressor harness

Troubleshooting



Caution

Be sure to turn off the power switch before connecting or disconnecting connectors, or parts may be damaged.
 (Precaution before turning on the power again)
 Make sure the power has been off for at least 30 seconds.

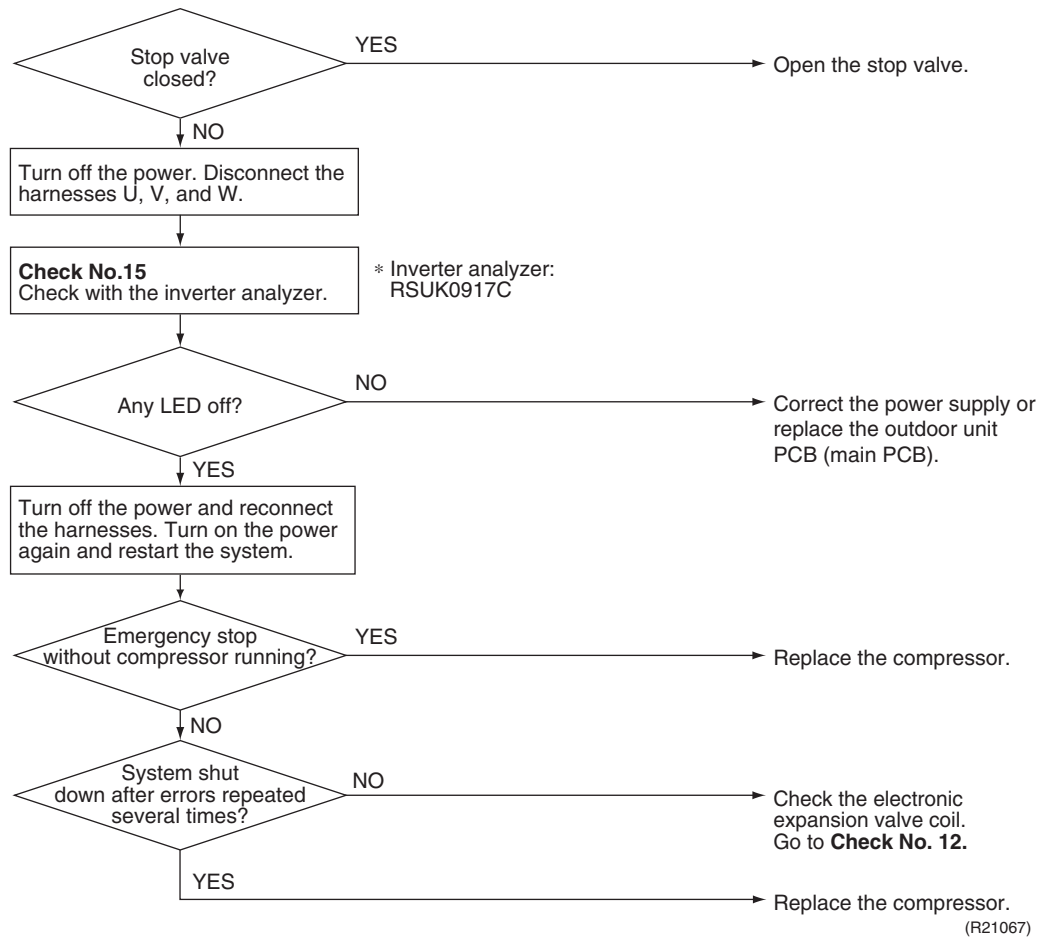

Reference

Check No.12 Refer to P.184



Reference

Check No.15 Refer to P.186

7.4 DC Fan Lock

Error Code	E7
Method of Error Detection	An error is determined with the high-voltage fan motor rotation speed detected by the Hall IC.
Error Decision Conditions	<ul style="list-style-type: none"> ■ The fan does not start in 15 ~ 30 seconds even when the fan motor is running. ■ If the error repeats, the system is shut down. ■ Reset condition: Continuous run for about 11 minutes without any other error
Supposed Causes	<ul style="list-style-type: none"> ■ Disconnection of the fan motor ■ Foreign matter stuck in the fan ■ Defective fan motor ■ Defective outdoor unit PCB
Troubleshooting	

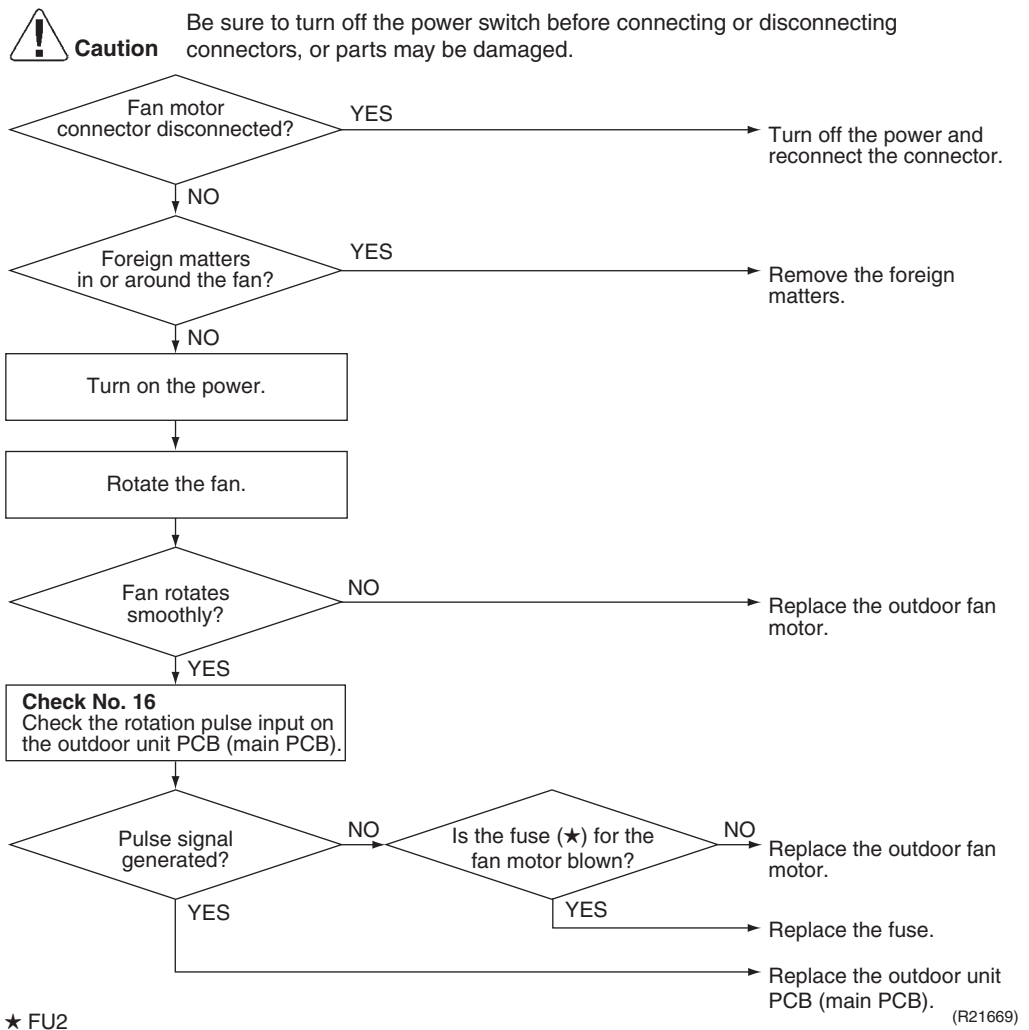

Reference

Check No.16 Refer to P.189

7.5 Input Overcurrent Detection

Error Code	E8
Method of Error Detection	An input overcurrent is detected by checking the input current value with the compressor running.
Error Decision Conditions	The current exceeds about 12.0 ~ 20.0 A (depending on the model) for 2.5 seconds with the compressor running. The upper limit of the current decreases when the outdoor temperature exceeds a certain level.
Supposed Causes	<ul style="list-style-type: none"> ■ Outdoor temperature is out of operation range. ■ Defective compressor ■ Defective power module ■ Defective outdoor unit PCB ■ Short circuit

Troubleshooting



Caution Be sure to turn off the power switch before connecting or disconnecting connectors, or parts may be damaged.

* An input overcurrent may result from wrong internal wiring. If the system is interrupted by an input overcurrent after the wires have been disconnected and reconnected for part replacement, check the wiring again.

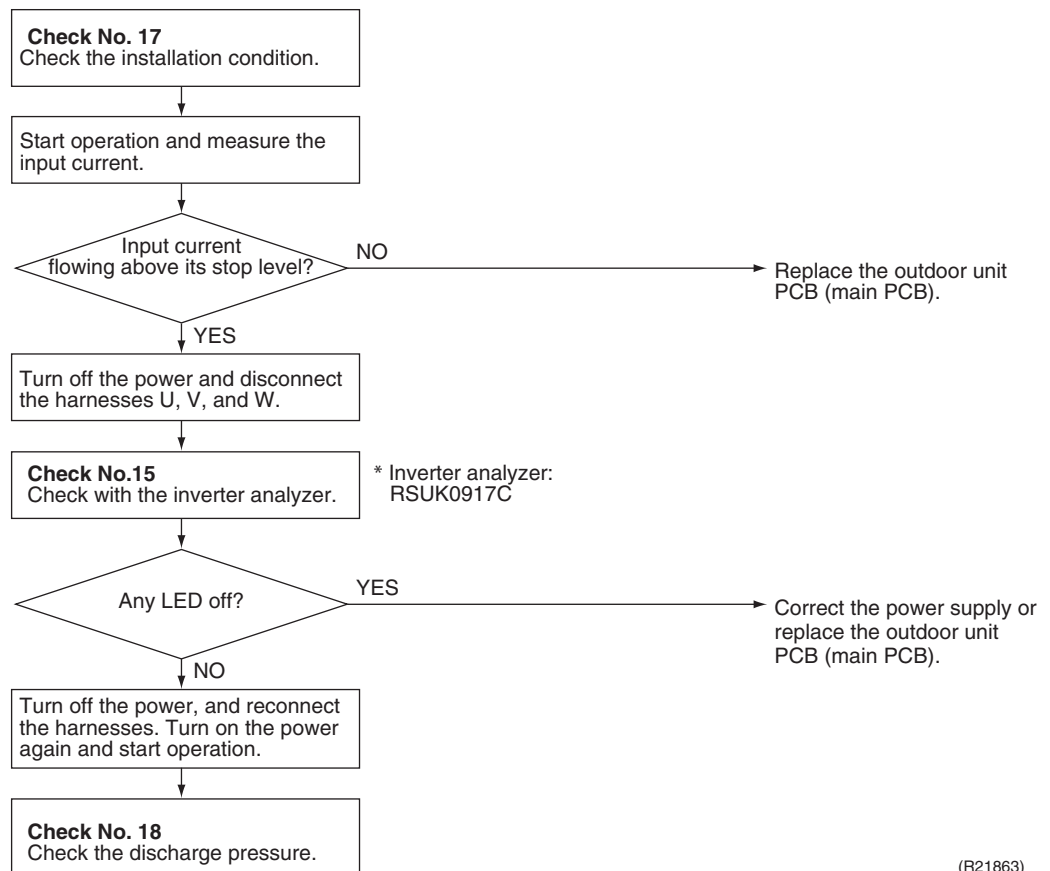

(R21863)



Reference Check No.15 Refer to P.186



Reference Check No.17 Refer to P.190



Reference

Check No.18 Refer to P.190

7.6 Four Way Valve Abnormality

Error Code	E8																											
Method of Error Detection	The room temperature thermistor and the indoor heat exchanger thermistor are checked if they function within their normal ranges in each operation mode.																											
Error Decision Conditions	<p>The following condition continues over C seconds after operating for 5 minutes.</p> <ul style="list-style-type: none"> ■ Cooling/Dry $A - B < -5^{\circ}\text{C}$ ($A - B < -9^{\circ}\text{F}$) ■ Heating $B - A < -5^{\circ}\text{C}$ ($B - A < -9^{\circ}\text{F}$) <p>A: Room thermistor temperature B: Indoor heat exchanger temperature</p> <table border="1"> <thead> <tr> <th rowspan="2">Outdoor temperature</th> <th colspan="5">C (seconds)</th> </tr> <tr> <th>09 class</th> <th>12 class</th> <th>15 class</th> <th>18 class</th> <th>24 class</th> </tr> </thead> <tbody> <tr> <td>-15°C (5°F) or higher</td> <td>300</td> <td>300</td> <td>300</td> <td>300</td> <td>300</td> </tr> <tr> <td>Lower than -15°C (5°F)</td> <td>600</td> <td>300</td> <td>1400</td> <td>1400</td> <td>1400</td> </tr> </tbody> </table>					Outdoor temperature	C (seconds)					09 class	12 class	15 class	18 class	24 class	-15°C (5°F) or higher	300	300	300	300	300	Lower than -15°C (5°F)	600	300	1400	1400	1400
Outdoor temperature	C (seconds)																											
	09 class	12 class	15 class	18 class	24 class																							
-15°C (5°F) or higher	300	300	300	300	300																							
Lower than -15°C (5°F)	600	300	1400	1400	1400																							
	<ul style="list-style-type: none"> ■ If the error repeats, the system is shut down. ■ Reset condition: Continuous run for about 60 minutes without any other error 																											
Supposed Causes	<ul style="list-style-type: none"> ■ Disconnection of four way valve coil ■ Defective four way valve, coil, or harness ■ Defective outdoor unit PCB ■ Defective thermistor(s) ■ Refrigerant shortage ■ Water mixed in refrigerant ■ Defective stop valve 																											

Troubleshooting



Caution Be sure to turn off the power switch before connecting or disconnecting connectors, or parts may be damaged.

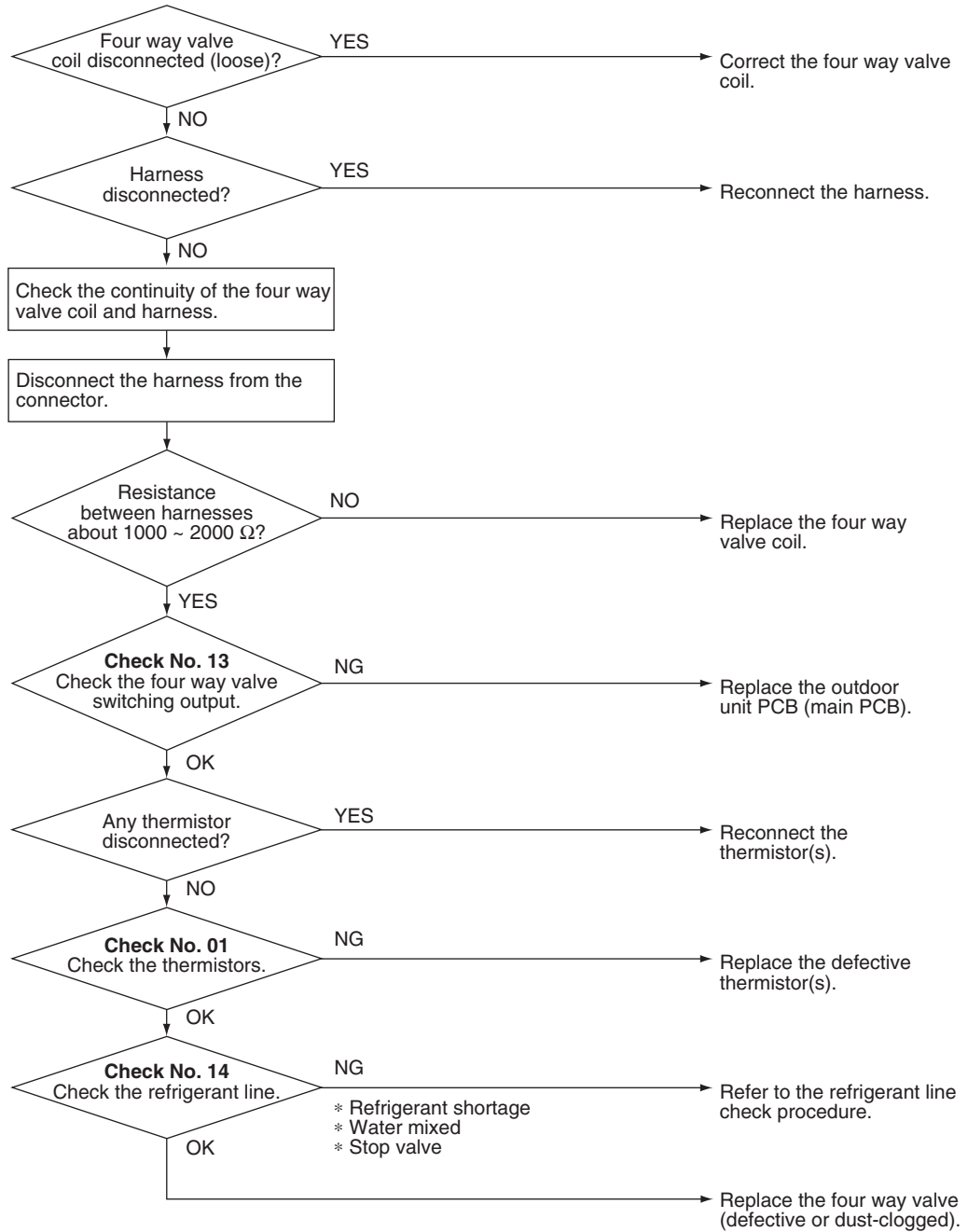

(R20405)



Reference Check No.01 Refer to P.181



Reference Check No.13 Refer to P.185



Reference Check No.14 Refer to P.185

7.7 Discharge Pipe Temperature Control

Error Code **F3**

Method of Error Detection An error is determined with the temperature detected by the discharge pipe thermistor.

- Error Decision Conditions**
- If the temperature detected by the discharge pipe thermistor rises above **A**, the compressor stops.
 - The error is cleared when the discharge pipe temperature has dropped below **B**.
 - If the error repeats, the system is shut down.
 - Reset condition: Continuous run for about 60 minutes without any other error

	A		B	
	(°C)	(°F)	(°C)	(°F)
09 class	110	230	88	190.4

★ If the frequency drops, the temperature is lowered in compensation.

	A		B	
	(°C)	(°F)	(°C)	(°F)
12/18/24 class	120	248	107	224.6
15 class	110	230	95	203

- Supposed Causes**
- Defective discharge pipe thermistor (Defective outdoor heat exchanger thermistor or outdoor temperature thermistor)
 - Defective electronic expansion valve or coil
 - Refrigerant shortage
 - Defective four way valve
 - Water mixed in refrigerant
 - Defective stop valve
 - Defective outdoor unit PCB

Troubleshooting



Caution Be sure to turn off the power switch before connecting or disconnecting connectors, or parts may be damaged.

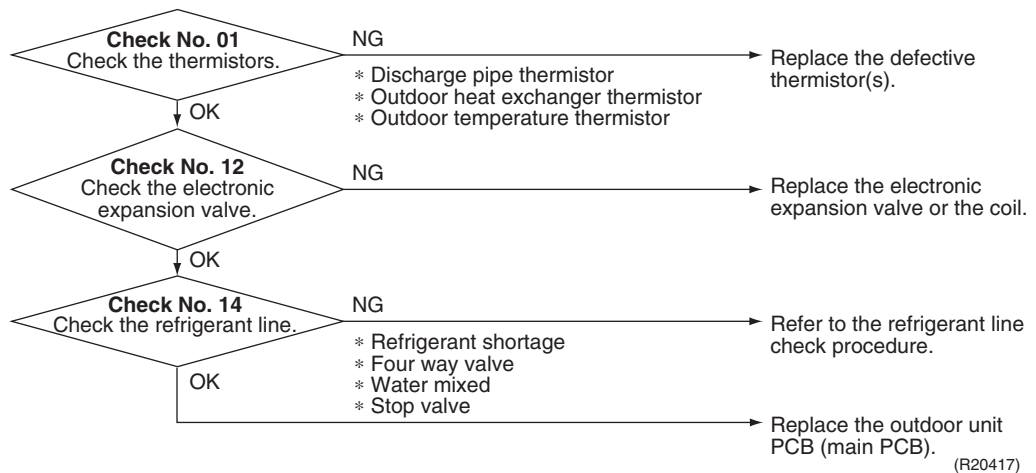

Reference Check No.01 Refer to P.181



Reference **Check No.12** Refer to P.184



Reference **Check No.14** Refer to P.185

7.8 High Pressure Control in Cooling

Error Code	F6
Method of Error Detection	High-pressure control (operation halt, frequency drop, etc.) is activated in cooling operation if the temperature sensed by the outdoor heat exchanger thermistor exceeds the limit.
Error Decision Conditions	<ul style="list-style-type: none"> ■ The temperature sensed by the outdoor heat exchanger thermistor rises above 60 ~ 62°C (140 ~ 143.6°F) (depending on the model). ■ The error is cleared when the temperature drops below 48.5 ~ 52°C (119.3 ~ 125.6°F) (depending on the model).
Supposed Causes	<ul style="list-style-type: none"> ■ Installation space not large enough ■ Dirty outdoor heat exchanger ■ Defective outdoor fan motor ■ Defective stop valve ■ Defective electronic expansion valve or coil ■ Defective outdoor heat exchanger thermistor ■ Defective outdoor unit PCB

Troubleshooting



Caution Be sure to turn off the power switch before connecting or disconnecting connectors, or parts may be damaged.

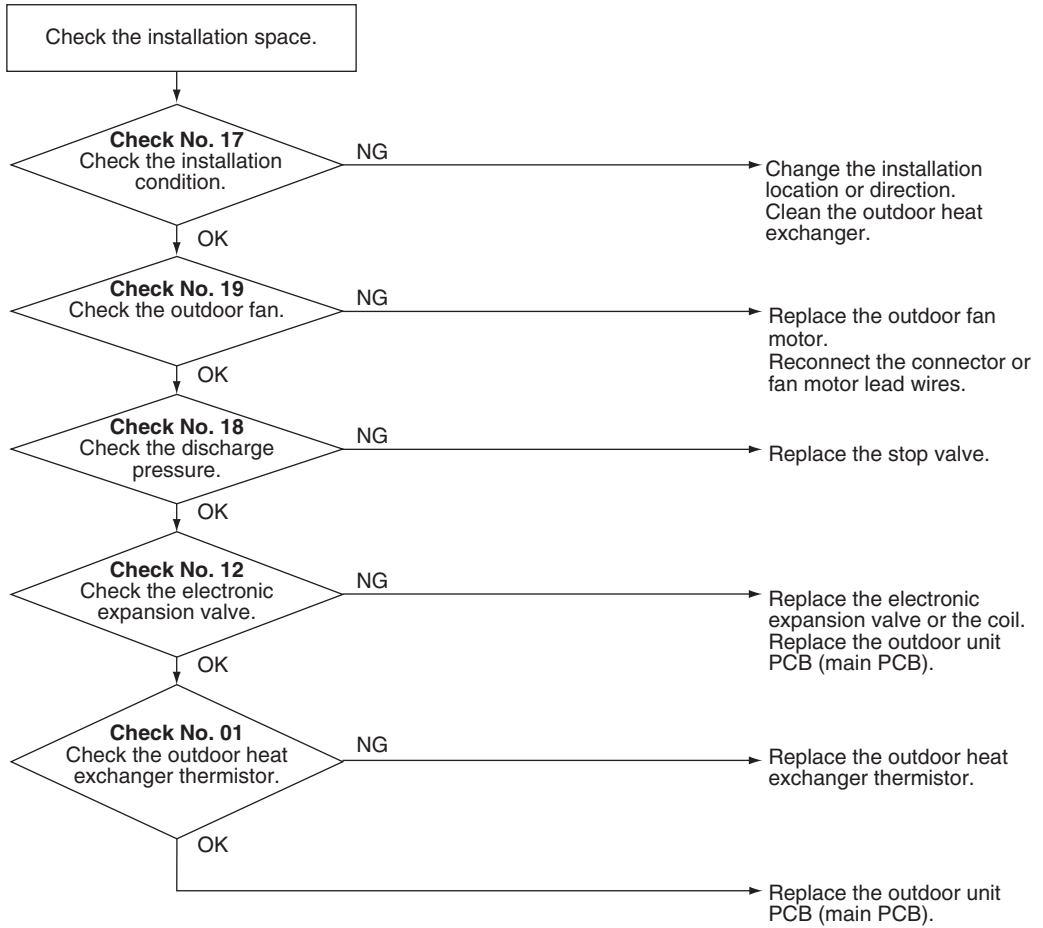

(R20418)



Reference Check No.01 Refer to P.181



Reference Check No.12 Refer to P.184



Reference Check No.17 Refer to P.190



Reference Check No.18 Refer to P.190



Reference Check No.19 Refer to P.191

7.9 System Shutdown due to Temperature Abnormality in the Compressor

Error Code	F8
Method of Error Detection	Operation is halted when the temperature detected by the discharge pipe thermistor exceeds the determined limit.
Error Decision Conditions	Temperature exceeds the detection threshold of 127.5°C (261.5°F) during forced cooling operation.
Supposed Causes	<ul style="list-style-type: none"> ■ Abnormal operation due to air intrusion ■ Defective discharge pipe thermistor

Troubleshooting



Caution

Be sure to turn off the power switch before connecting or disconnecting connectors, or parts may be damaged.

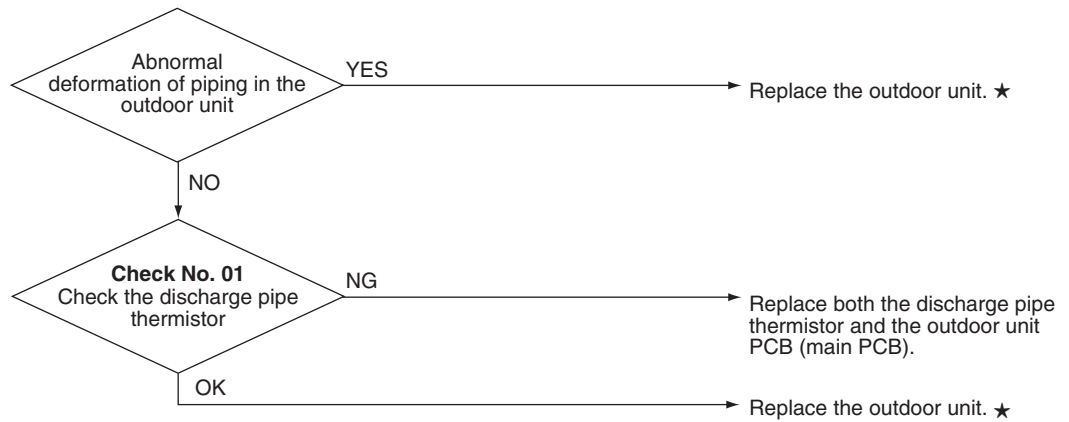

★ Replace the unit as directed in the installation manual, making sure that air does not intrude into the refrigerant pipings.

(R23655)



Reference

Check No.01 Refer to P.181

7.10 Compressor Sensor System Abnormality

Error Code	H0
Method of Error Detection	The system checks the DC current before the compressor starts.
Error Decision Conditions	<ul style="list-style-type: none"> ■ The voltage converted from the DC current before compressor start-up is out of the range 0.5 ~ 4.5 V. ■ The DC voltage before compressor start-up is below 50 V.
Supposed Causes	<ul style="list-style-type: none"> ■ Broken or disconnected harness ■ Defective outdoor unit PCB
Troubleshooting	

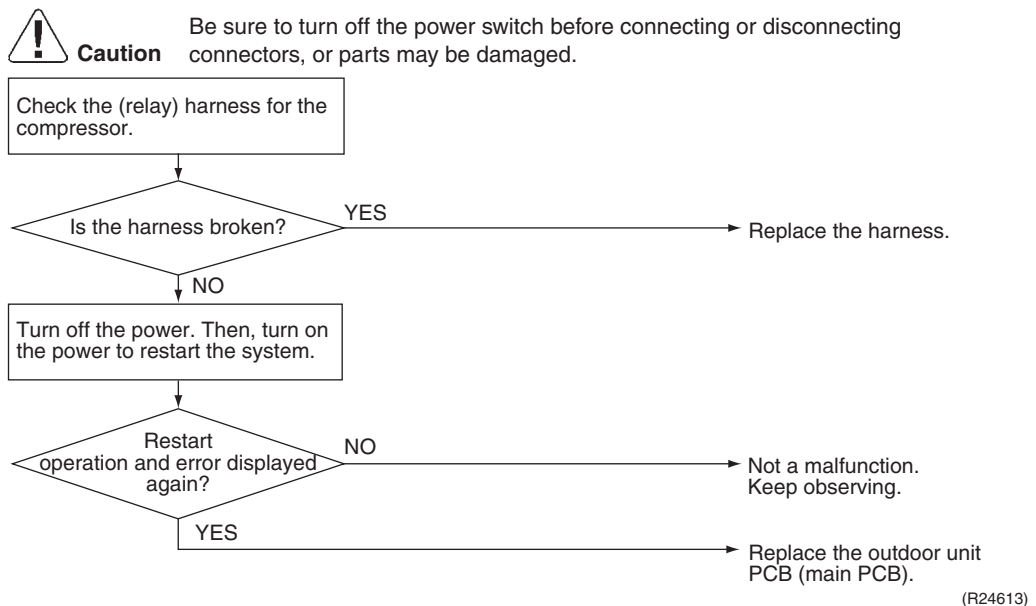

7.11 Position Sensor Abnormality

Error Code	H5
Method of Error Detection	A compressor start-up failure is detected by checking the compressor running condition through the position detection circuit.
Error Decision Conditions	<ul style="list-style-type: none"> ■ If the error repeats, the system is shut down. ■ Reset condition: Continuous run for about 11 minutes without any other error
Supposed Causes	<ul style="list-style-type: none"> ■ Power supply voltage out of specification ■ Disconnection of the compressor harness ■ Defective compressor ■ Defective outdoor unit PCB ■ Start-up failure caused by the closed stop valve ■ Input voltage outside the specified range

Troubleshooting



Caution Be sure to turn off the power switch before connecting or disconnecting connectors, or parts may be damaged.

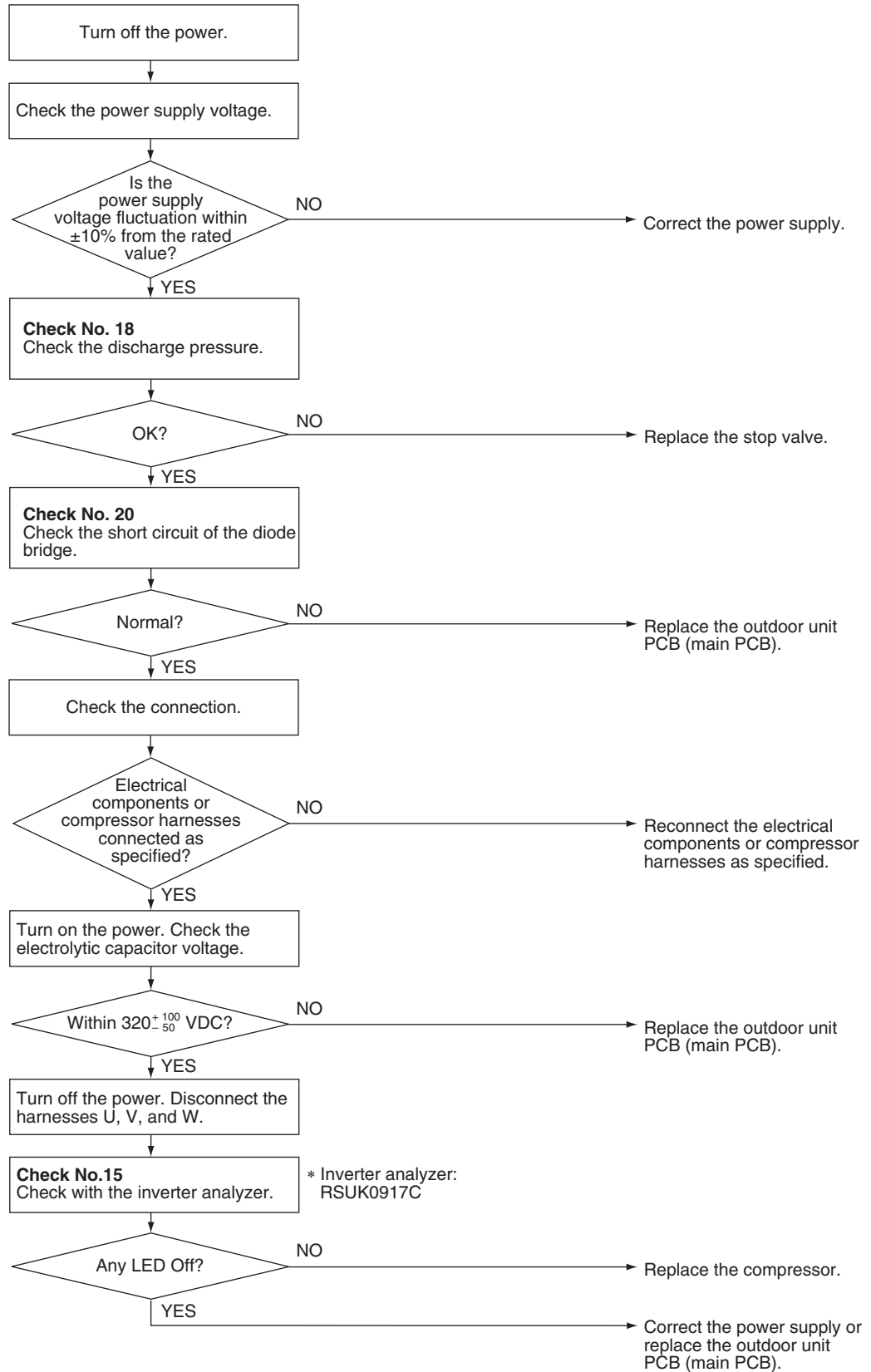

(R22764)



Reference **Check No.15** Refer to P.186



Reference **Check No.18** Refer to P.190



Reference **Check No.20** Refer to P.191

7.12 Thermistor or Related Abnormality (Outdoor Unit)

Error Code	<i>H9, U3, U6, P4</i>
Method of Error Detection	This fault is identified based on the thermistor input voltage to the microcomputer. A thermistor fault is identified based on the temperature sensed by each thermistor.
Error Decision Conditions	<ul style="list-style-type: none"> ■ The voltage between the both ends of the thermistor is either 4.96 V or more, or 0.04 V or less with the power on. ■ <i>U3</i> error is judged if the discharge pipe temperature is lower than the heat exchanger temperature.
Supposed Causes	<ul style="list-style-type: none"> ■ Disconnection of the connector for the thermistor ■ Defective thermistor(s) ■ Defective heat exchanger thermistor in the case of <i>U3</i> error (outdoor heat exchanger thermistor in cooling operation, or indoor heat exchanger thermistor in heating operation) ■ Defective outdoor unit PCB
Troubleshooting	<p>In case of <i>P4</i></p> <div style="display: flex; align-items: center;">  <div> <p>Caution Be sure to turn off the power switch before connecting or disconnecting connectors, or parts may be damaged.</p> </div> </div>

Replace the outdoor unit PCB (main PCB).

P4 : Radiation fin thermistor

Troubleshooting In case of *H9*, *J3*, *J5*



Caution Be sure to turn off the power switch before connecting or disconnecting connectors, or parts may be damaged.

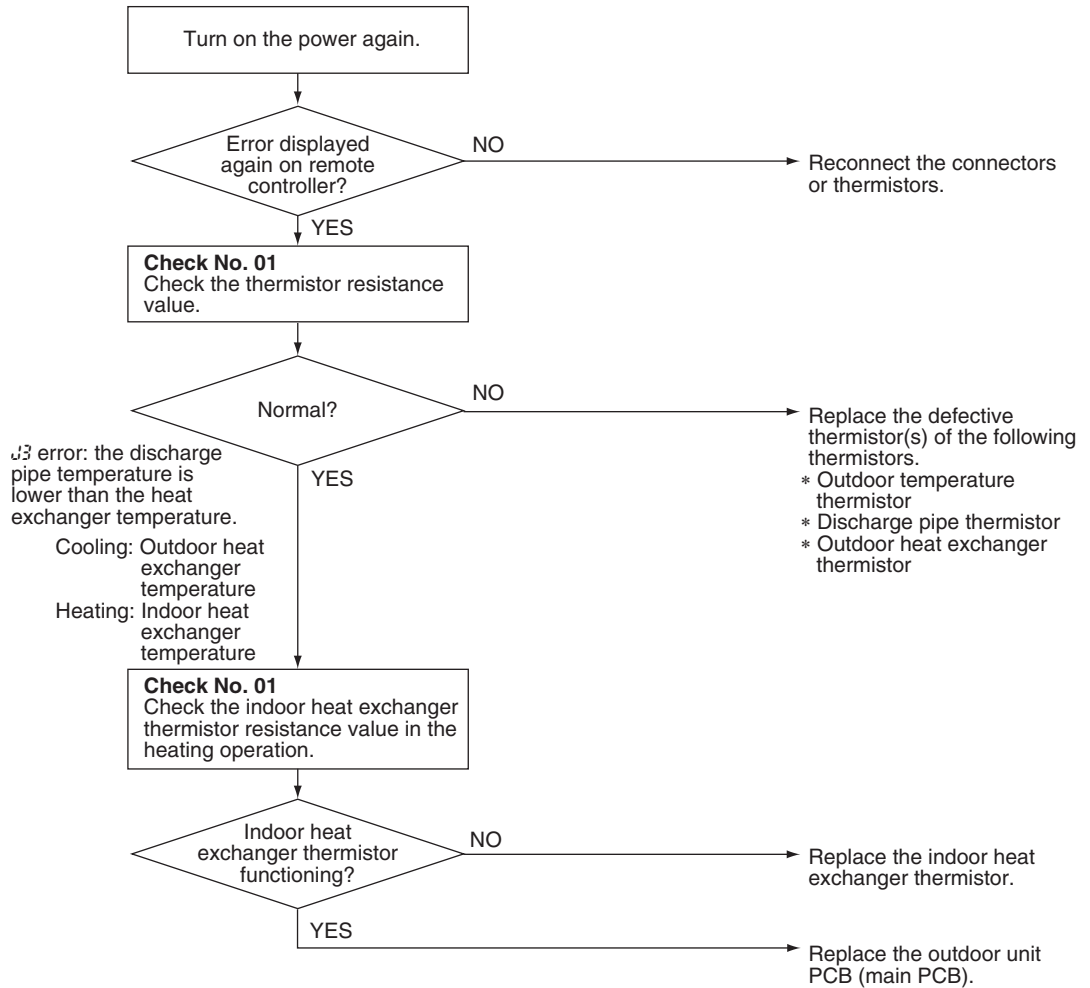

(R20406)

- H9* : Outdoor temperature thermistor
- J3* : Discharge pipe thermistor
- J5* : Outdoor heat exchanger thermistor



Reference

Check No.01 Refer to P.181

7.13 Electrical Box Temperature Rise

Error Code **E3**

Method of Error Detection An electrical box temperature rise is detected by checking the radiation fin thermistor with the compressor off.

Error Decision Conditions

- With the compressor off, the radiation fin temperature is above **A**.
- The error is cleared when the radiation fin temperature drops below **B**.
- To cool the electrical components, the outdoor fan starts when the radiation fin temperature rises above **C** and stops when the radiation fin temperature drops below **B**.

	A		B		C	
	(°C)	(°F)	(°C)	(°F)	(°C)	(°F)
09 class	82	179.6	65	149	70	158
12 class	90	194	75	167	81	177.8
15 class	90	194	64	147.2	81	177.8
18/24 class	92	197.6	70	158	77	170.6

Supposed Causes

- Defective outdoor fan motor
- Short circuit
- Defective radiation fin thermistor
- Disconnection of connector
- Defective outdoor unit PCB

Troubleshooting

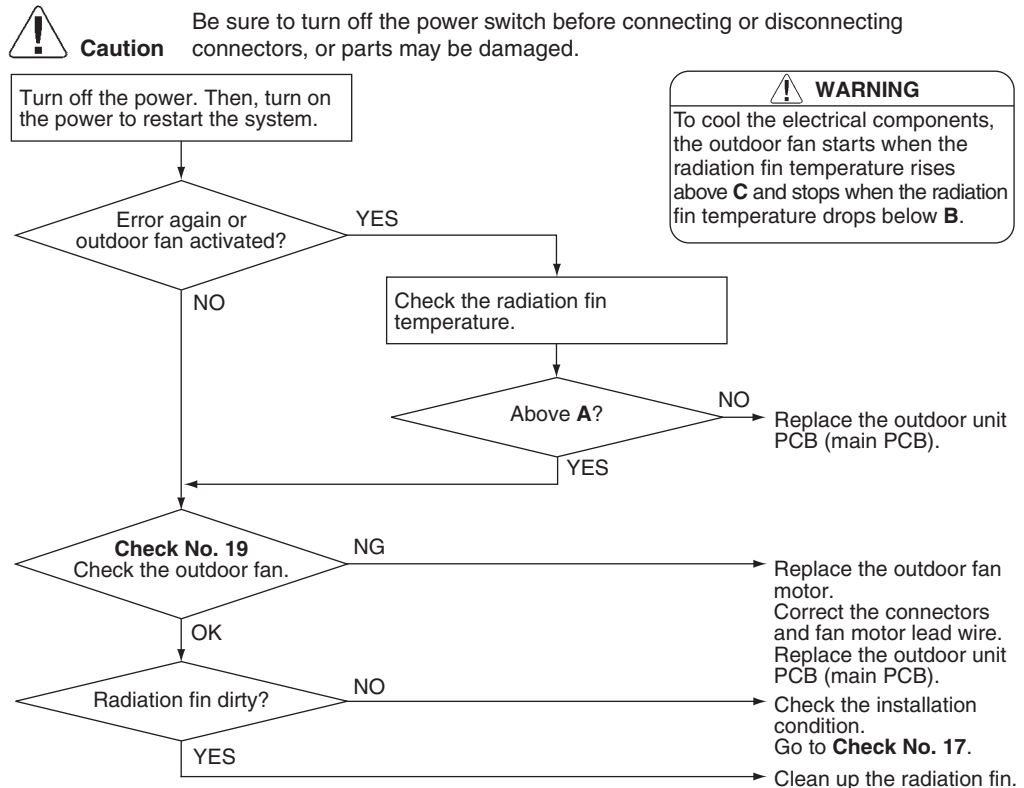

(R22998)



Reference

Check No.17 Refer to P.190



Reference

Check No.19 Refer to P.191

7.14 Radiation Fin Temperature Rise

Error Code

L4

Method of Error Detection

A radiation fin temperature rise is detected by checking the radiation fin thermistor with the compressor on.

Error Decision Conditions

- If the radiation fin temperature with the compressor on is above **A**.
- The error is cleared when the radiation fin temperature drops below **B**.
- If the error repeats, the system is shut down.
- Reset condition: Continuous run for about 60 minutes without any other error

	A		B	
	(°C)	(°F)	(°C)	(°F)
09 class	99	210.2	70	158
12 class	90	194	84	183.2
15 class	100	212	57	134.6
18/24 class	82	179.6	77	170.6

Supposed Causes

- Defective outdoor fan motor
- Short circuit
- Defective radiation fin thermistor
- Disconnection of connector
- Defective outdoor unit PCB
- Silicone grease not applied properly on the radiation fin after replacing the outdoor unit PCB

Troubleshooting



Caution Be sure to turn off the power switch before connecting or disconnecting connectors, or parts may be damaged.

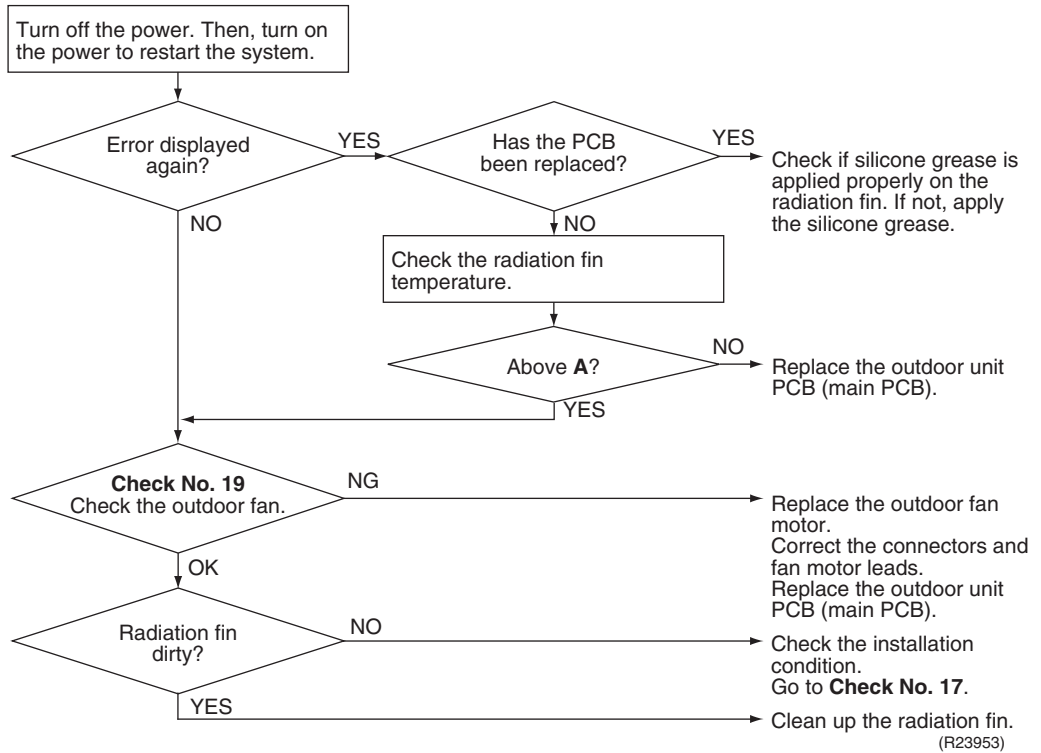

Note Refer to Silicone Grease on Power Transistor/Diode Bridge on page 219 for details.



Reference Check No.17 Refer to P.190



Reference Check No.19 Refer to P.191

7.15 Output Overcurrent Detection

Error Code	L5
Method of Error Detection	An output overcurrent is detected by checking the current that flows in the inverter DC section.
Error Decision Conditions	<ul style="list-style-type: none"> ■ A position signal error occurs while the compressor is running. ■ A rotation speed error occurs while the compressor is running. ■ An output overcurrent signal is fed from the output overcurrent detection circuit to the microcomputer. ■ If the error repeats, the system is shut down. ■ Reset condition: Continuous run for about 11 minutes without any other error
Supposed Causes	<ul style="list-style-type: none"> ■ Poor installation condition ■ Closed stop valve ■ Defective power module ■ Wrong internal wiring ■ Abnormal power supply voltage ■ Defective outdoor unit PCB ■ Power supply voltage out of specification ■ Defective compressor

Troubleshooting



Caution

Be sure to turn off the power switch before connecting or disconnecting connectors, or parts may be damaged.



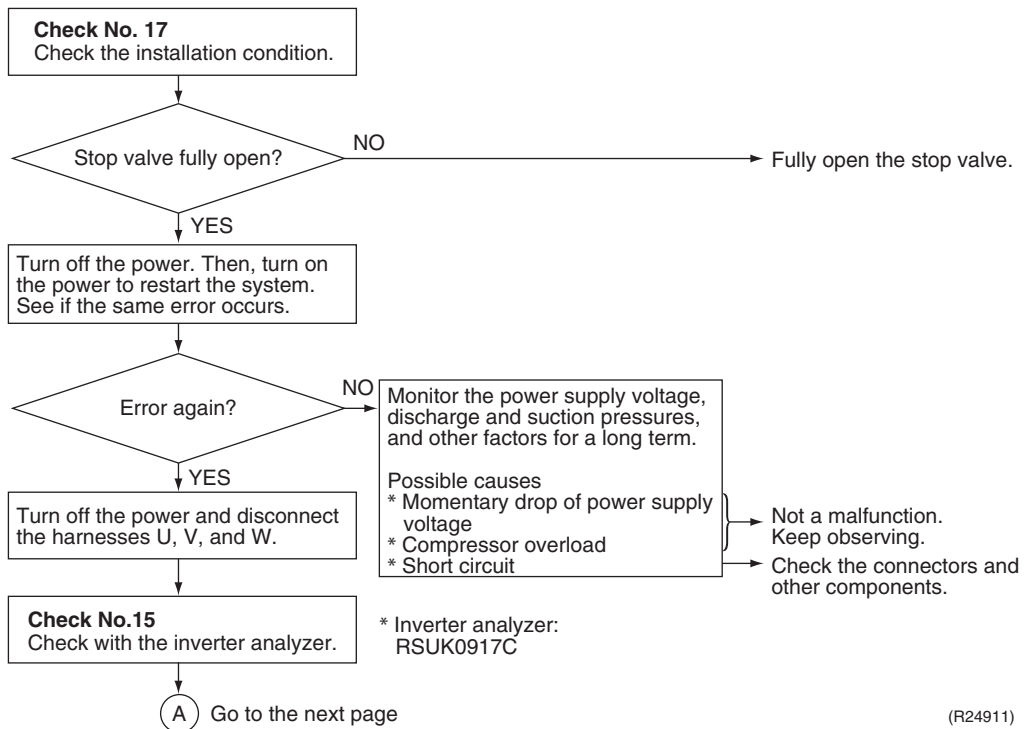

* An output overcurrent may result from wrong internal wiring. If the system is interrupted by an output overcurrent after the wires have been disconnected and reconnected for part replacement, check the wiring again.

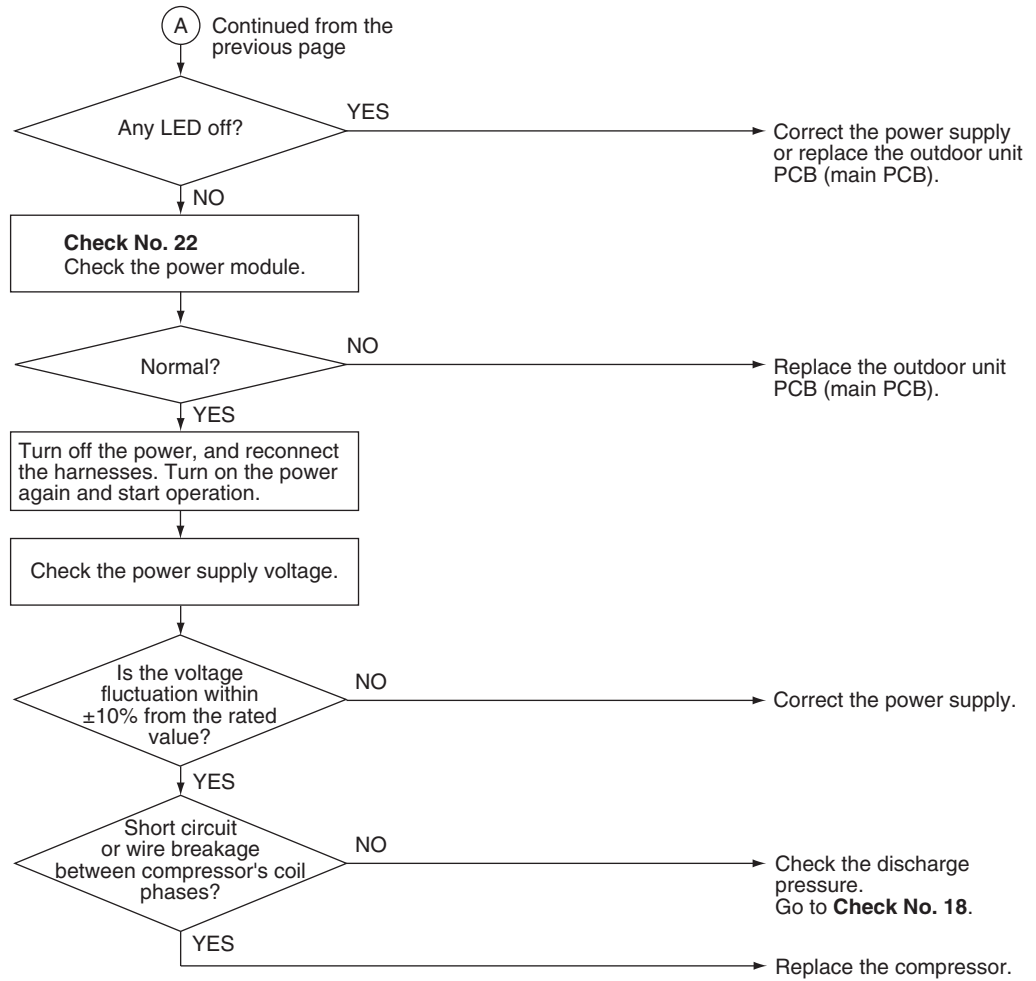

(R24911)



(R24912)

-  **Reference** **Check No.15** Refer to P.186
-  **Reference** **Check No.17** Refer to P.190
-  **Reference** **Check No.18** Refer to P.190
-  **Reference** **Check No.22** Refer to P.194

7.16 Signal Transmission Error on Outdoor Unit PCB

Error Code	U7
Method of Error Detection	Communication error between microcomputer mounted on the main PCB and PM1.
Error Decision Conditions	<ul style="list-style-type: none"> ■ The abnormality is determined when the data sent from the PM1 cannot be received for 9 seconds. ■ The error counter is reset when the data from the PM1 can be successfully received.
Supposed Causes	<ul style="list-style-type: none"> ■ Defective outdoor unit PCB
Troubleshooting	

**Caution**

Be sure to turn off the power switch before connecting or disconnecting connectors, or parts may be damaged.

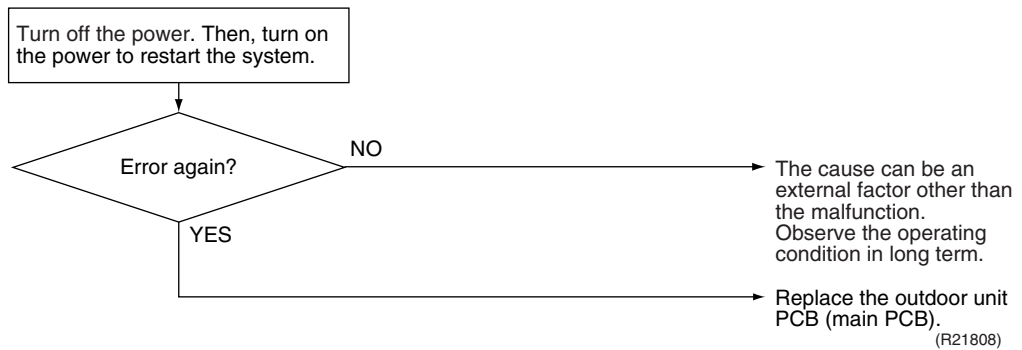

8. Check

8.1 Thermistor Resistance Check

Check No.01

Measure the resistance of each thermistor using multimeter.

The resistance values are defined by below table.

If the measured resistance value does not match the listed value, the thermistor must be replaced.

- Disconnect the connector of thermistor ASSY from the PCB to measure the resistance between the pins using multimeter.
- To check the thermistor soldered on a PCB, disconnect the PCB from other PCB/parts, and measure the resistance between the both ends of soldered thermistor.

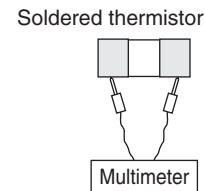
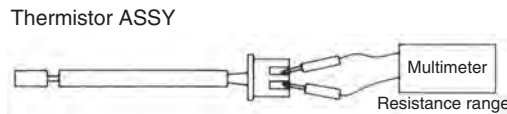

Thermistor temperature		Type A	Type B
°C	°F	R(25°C / 77°F) = 20 kΩ B = 3950 K	R(25°C / 77°F) = 10 kΩ B = 3435 K
-20	-4	197.8	73.4
-15	5	148.2	57.0
-10	14	112.1	44.7
-5	23	85.60	35.3
0	32	65.93	28.2
5	41	51.14	22.6
10	50	39.99	18.3
15	59	31.52	14.8
20	68	25.02	12.1
25	77	20.00	10.0
30	86	16.10	8.2
35	95	13.04	6.9
40	104	10.62	5.8
45	113	8.707	4.9
50	122	7.176	4.1

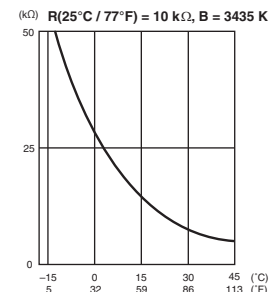
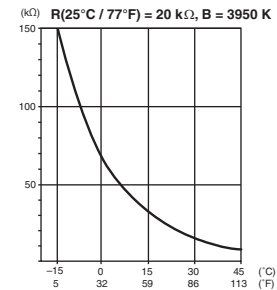

R6000680

Thermistor			FTX09/12/15 NMVJU	FTX18/24UVJU FVXS series	FDMQ series
Indoor Unit	R1T	Room temperature thermistor	B	A	—
	R2T	Indoor heat exchanger thermistor	A	A	—
	R1T	Suction air thermistor	—	—	A
	R2T	Middle thermistor	—	—	A
	R3T	Liquid pipe thermistor	A	A	A
Outdoor Unit	R1T	Outdoor air temperature thermistor	A	A	A
	R2T	Outdoor heat exchanger thermistor	A	A	A
	R3T	Discharge pipe thermistor	A	A	A



Note(s) When replacing the defective thermistor(s), replace the thermistor as ASSY.

8.2 Indoor Fan Motor Connector Check

Check No.03

FTX09/12/15NMVJU

- Fan motor wire breakdown/short circuit check
 - (1) Check the connector for connection.
 - (2) Turn the power off.
 - (3) Check if each resistance at the phases U - V and V - W is within specified range in the table below.

- Motor control voltage check
 - (1) Check the connector for connection.
 - (2) Check the motor control voltage is generated (between the pins 2 - 3).

- Rotation pulse check
 - (1) Check the connector for connection.
 - (2) Turn the power on and stop the operation.
 - (3) Check if the Hall IC generates the rotation pulse 4 times when the fan motor is manually rotated once (between the pins 1 - 3).

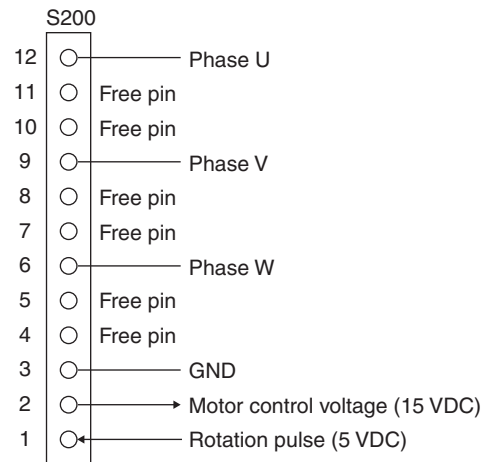

R6000090

	U-V/V-W Resistance (Ω)
FTX09/12NMVJU	67.0 ~ 85.1
FTX15NMVJU	39.6 ~ 50.3



Note

A measurement error might occur in the resistance value depending on the measurement conditions and the method.

Check No.02

FTX18/24UVJU, FVXS Series

1. Check the connection of connector.
2. Check motor power supply voltage output (pins 4 - 7).
3. Check motor control voltage (pins 4 - 3).
4. Check rotation command voltage output (pins 4 - 2).
5. Check rotation pulse input (pins 4 - 1).

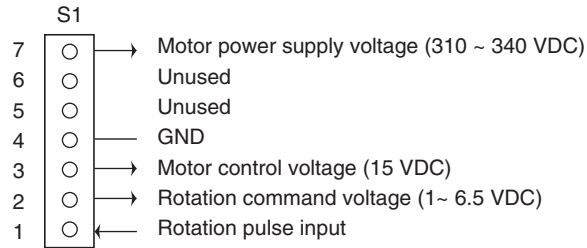

R6000681

FDMQ Series

1. Turn the power supply OFF.
2. With the fan motor connector disconnected, measure the resistance between each pin, then make sure that the resistance is more than the value mentioned in the following table.

Measuring points	Judgement
White - Blue	1 MΩ or more
Orange - Blue	100 kΩ or more
Brown - Blue	100 Ω or more
Red - Blue	100 kΩ or more

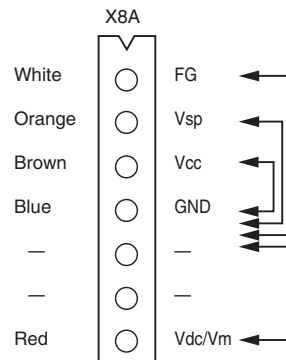

(R25080)

8.3 Power Supply Waveform Check

Check No.11

Measure the power supply waveform between No. 1 and No. 2 on the terminal strip, and check the waveform disturbance.

- Check if the power supply waveform is a sine wave (Fig.1).
- Check if there is waveform disturbance near the zero-cross (sections circled in Fig.2).

[Fig.1]

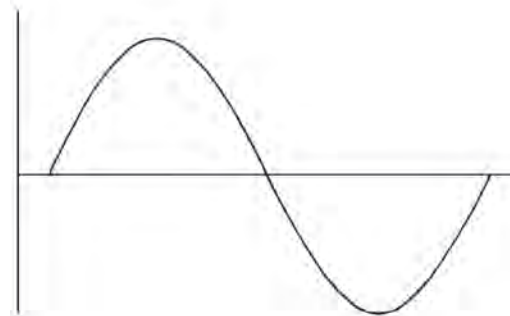

[Fig.2]

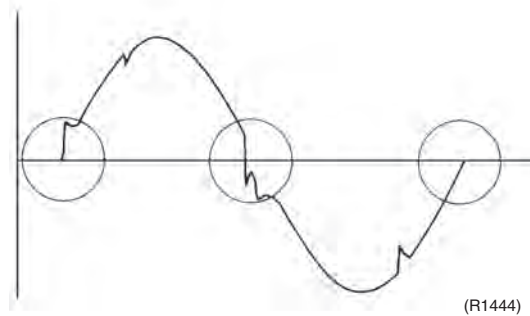

8.4 Electronic Expansion Valve Check

Check No.12

Conduct the following to check the electronic expansion valve (EV).

1. Check if the EV connector is correctly connected to the PCB.
2. Turn the power off and on again, and check if the EV generates a latching sound.
3. If the EV does not generate a latching sound in step 2, disconnect the connector and check the continuity using a multimeter.
4. Check the continuity between the pins 5 - 1, 5 - 2, 5 - 3, 5 - 4 (between the pins 6 - 1, 6 - 2, 6 - 3, and 6 - 4 for the 6P connector models). If there is no continuity between the pins, the EV coil is faulty.
5. If the continuity is confirmed in step 3, the outdoor unit PCB (main PCB) is faulty.

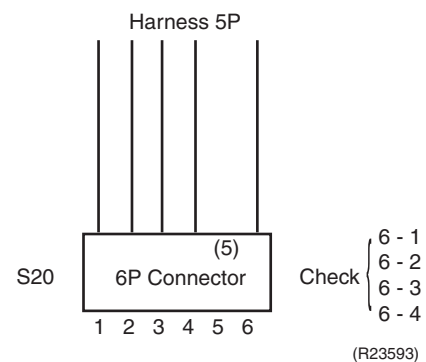
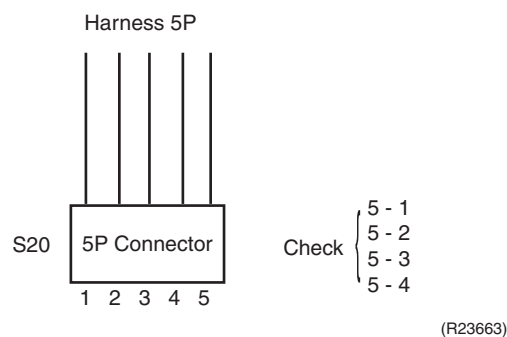

8.5 Four Way Valve Performance Check

Check No.13

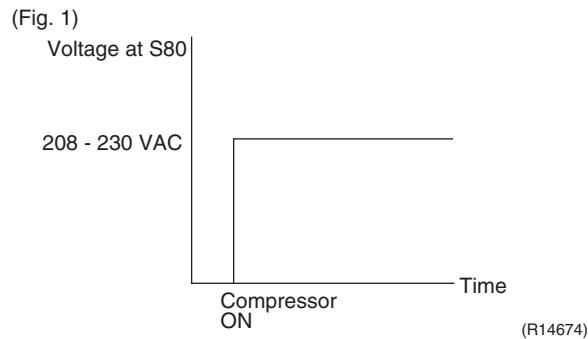
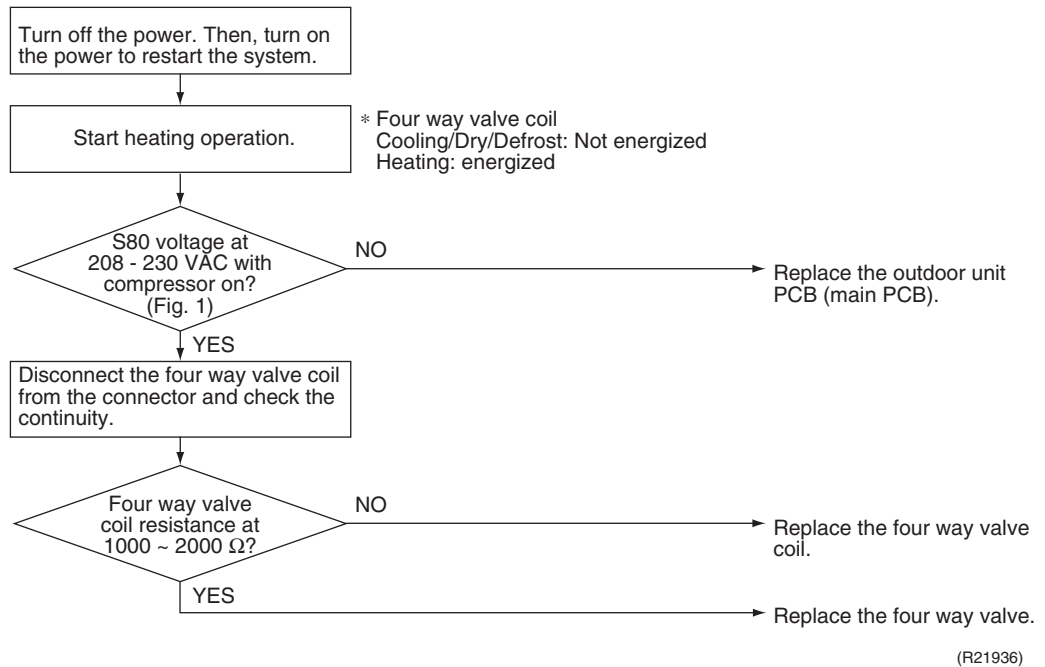

8.6 Inverter Unit Refrigerant System Check

Check No.14

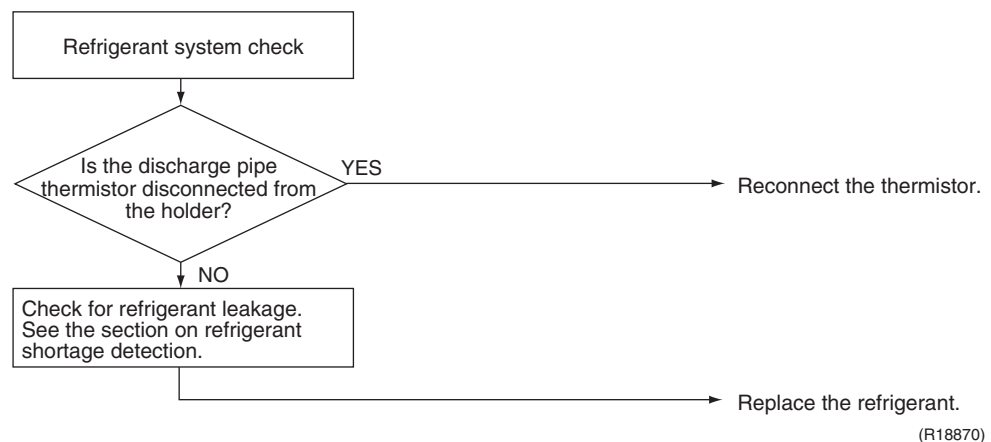

8.7 Inverter Analyzer Check

Check No.15

■ Characteristics

Inverter analyzer: RSUK0917C

If an abnormal stop occurs due to compressor startup failure or overcurrent output when using an inverter unit, it is difficult to judge whether the stop is caused by the compressor failure or some other failure (main PCB, power module, etc.). The inverter analyzer makes it possible to judge the cause of trouble easily and securely. Connect an inverter analyzer as a quasi-compressor instead of compressor and check the output of the inverter.

■ Operation Method

Step 1

Be sure to turn the power off.

Step 2

Install an inverter analyzer instead of a compressor.

Note:

Make sure the charged voltage of the built-in smoothing electrolytic capacitor drops to 10 VDC or below before carrying out the service work.

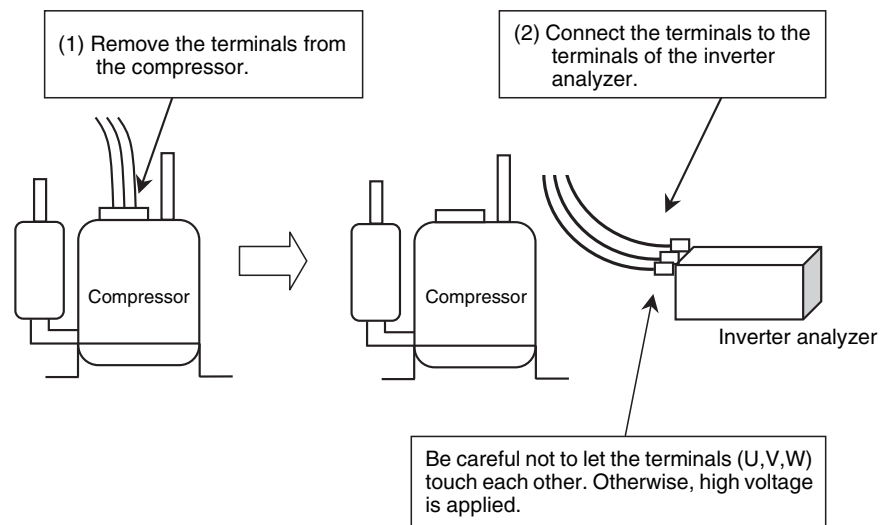

R6000682

Reference:

If the terminals of the compressor are not FASTON terminals (difficult to remove the wire on the terminals), it is possible to connect wires available on site to the outdoor unit from output side of PCB. Do not connect them to the compressor at the same time, otherwise it may result in incorrect detection.

Step 3

Activate the power transistor test operation from the outdoor unit.



Note

Power transistor test operation can be activated only once after turning on the power supply. If reactivation of the power supply transistor operation is needed, turn the power supply off and then on again.

FTX09/12/15NMVJU

1. Turn the power on.
2. Press the center of **TEMP** button and **OFF** button on the remote controller at the same time.
3. Select ? with **TEMP**^ or **TEMP**∨ button.
4. Press **FAN** button.
5. Press **FAN ONLY** button to start the power transistor test operation.

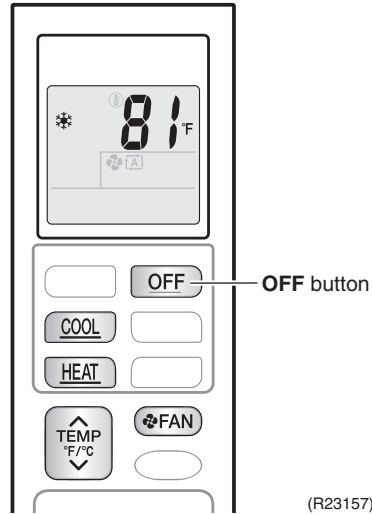
**FTX18/24UVJU, FVXS series**



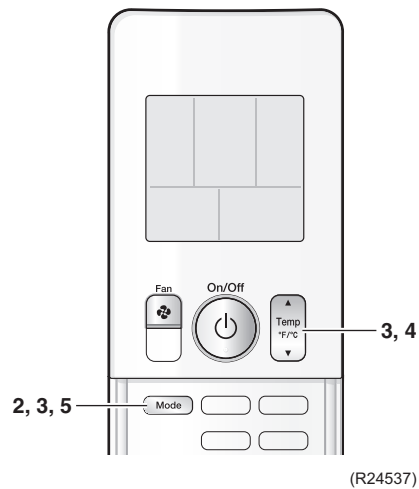

1. Turn the power on.
2. Select FAN operation with the **Mode** button on the remote controller.
3. Press the center of the **Temp** button and the **Mode** button at the same time.
4. Select ? with the **Temp**▲ or **Temp**▼ button.
5. Press the **Mode** button to start the power transistor test operation.

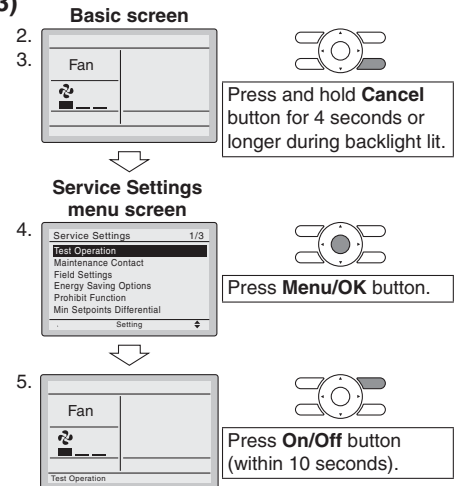

FDMQ series with Wired Remote Controller (BRC1E73)

1. Turn the power on.
2. Set FAN operation using the remote controller.
3. Press and hold **Cancel** button for 4 seconds or longer.
4. Select **Test Operation** in the service settings menu, then press **Menu/OK** button.
→ Basic screen returns and “Test Operation” is displayed at the bottom.
5. Press **On/Off** button within 10 seconds.
→ 3 minutes after pressing **On/Off** button, power transistor test operation will start.
- Test operation will stop automatically after about 30 minutes.
To stop the operation, press **On/Off** button.

**FDMQ series with Wireless Remote Controller (BRC082A43)**

1. Turn the power on.
2. Press  and select FAN operation.
3. Press  twice. “TEST” is displayed.
4. Press  within 10 seconds.
→ 3 minutes after pressing , power transistor test operation will start.
- Test operation will stop automatically after about 30 minutes.
To stop the operation, press .

■ Diagnose method (Diagnose according to 6 LEDs lighting status.)

1. If all the LEDs are lit uniformly, the compressor is defective.
→ Replace the compressor.
2. If the LEDs are not lit uniformly, check the power module.
→ Refer to **Check No.22**.
3. If NG in **Check No.22**, replace the power module.
(Replace the main PCB. The power module (IPM1) is united with the main PCB.)
If OK in **Check No.22**, check if there is any solder cracking on the PCB.
4. If any solder cracking is found, replace the PCB or repair the soldered section.
If there is no solder cracking, replace the PCB.

**Caution**

1. When the output frequency is low, the LEDs blink slowly. As the output frequency increases, the LEDs blink quicker. (The LEDs look like they are lit.)
2. On completion of the inverter analyzer diagnosis, be sure to re-crimp the FASTON terminals. Otherwise, the terminals may be burned due to loosening.

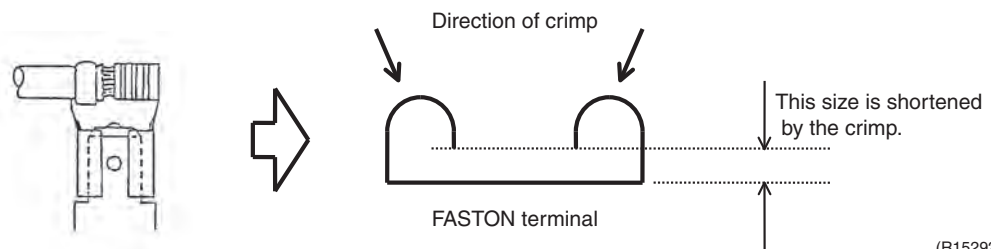

(R15292)

8.8 Rotation Pulse Check on the Outdoor Unit PCB

Check No.16

Make sure that the voltage is within $320 \pm \frac{100}{50}$ VDC.

1. Set operation off and power off. Disconnect the connector S70 or S71.
2. Check that the voltage between the pins 4 - 7 is 320 VDC.
3. Check that the control voltage between the pins 4 - 3 is 15 VDC.
4. Check that the rotation command voltage between the pins 4 - 2 is 0 ~ 6.5 VDC.
5. Keep operation off and power off. Connect the connector S70 or S71.
6. Check whether 4 rotation pulses (0 ~ 15 VDC) are input at the pins 4 - 1 when the fan motor is rotated 1 turn by hand.

When the fuse is melted, check the outdoor fan motor for proper function.

If NG in step 2 → Defective PCB → Replace the outdoor unit PCB (main PCB).

If NG in step 4 → Defective Hall IC → Replace the outdoor fan motor.

If OK in both steps 2 and 4 → Replace the outdoor unit PCB (main PCB).

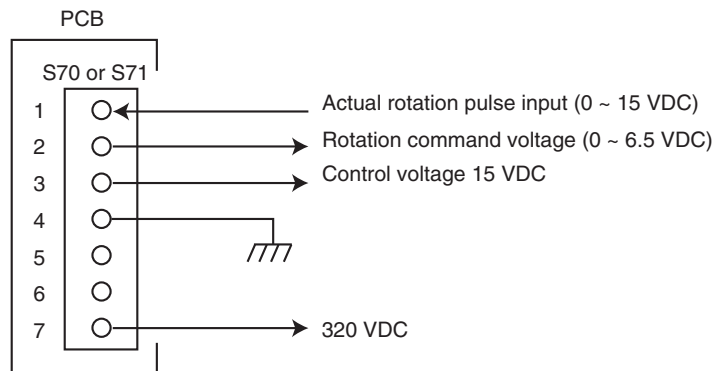

(R20507)

8.9 Installation Condition Check

Check No.17

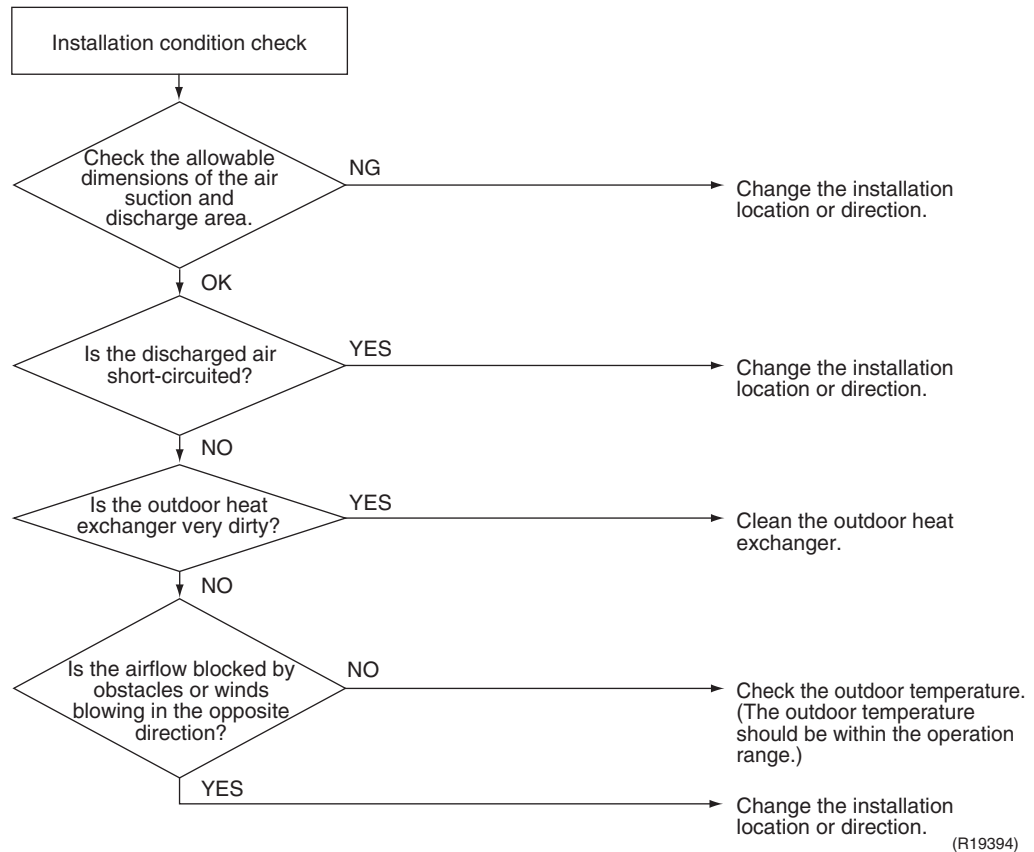

8.10 Discharge Pressure Check

Check No.18

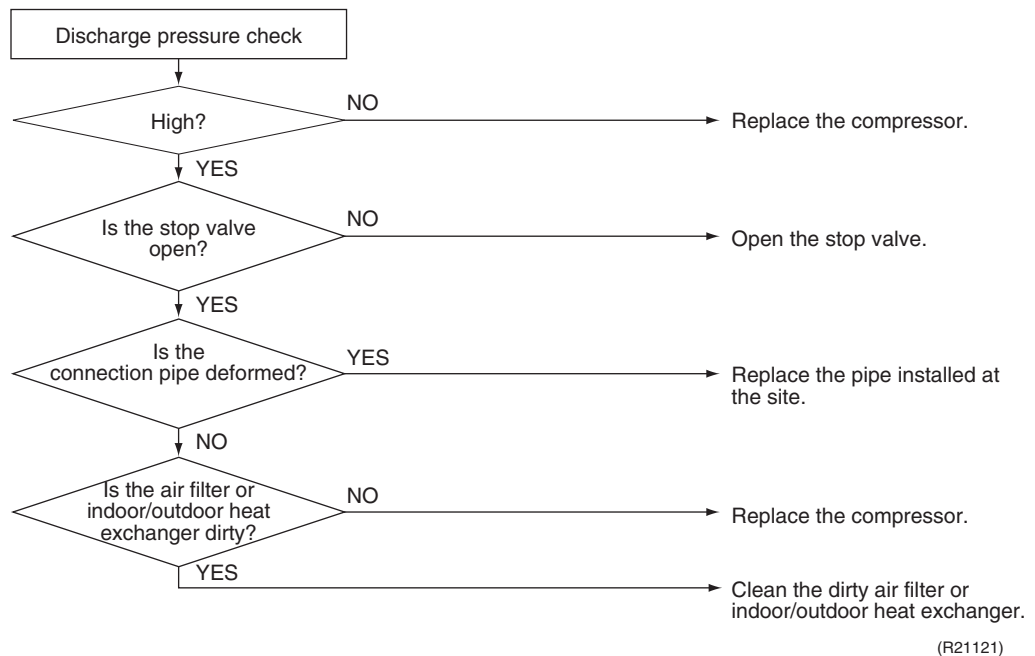

8.11 Outdoor Fan System Check

Check No.19 DC motor

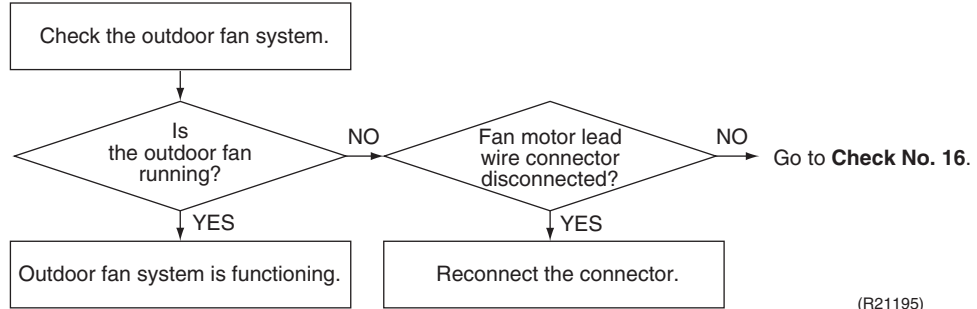

(R21195)

8.12 Main Circuit Short Check

Check No.20

Check to make sure that the voltage between (+) and (-) of the diode bridge (DB1) is about 0 V before checking

- Measure the resistance between the pins of the DB1 referring to the table below.
- If the resistance is ∞ or less than 1 k Ω , short circuit occurs on the main circuit.

Positive terminal (+) of digital multimeter	~ (2, 3)	+ (4)	~ (2, 3)	- (1)
Negative terminal (-) of digital multimeter	+ (4)	~ (2, 3)	- (1)	~ (2, 3)
Resistance is OK.	several k Ω ~ several M Ω			
Resistance is NG.	0 Ω or ∞			

09 class

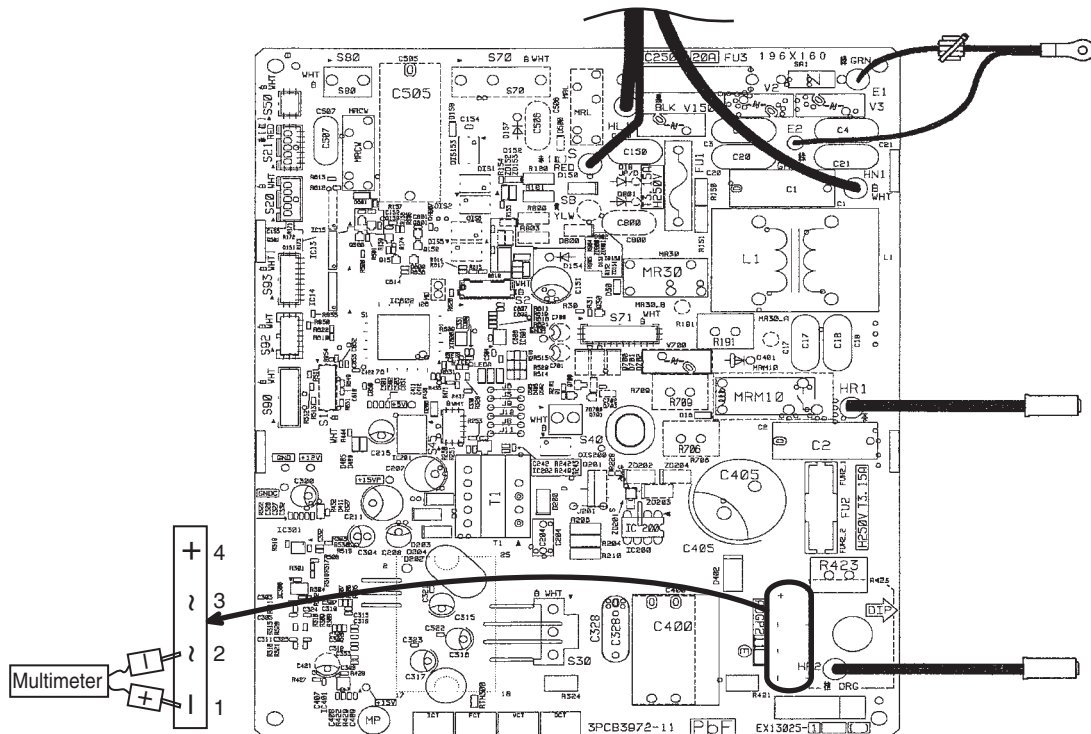

(R20698)

12 class

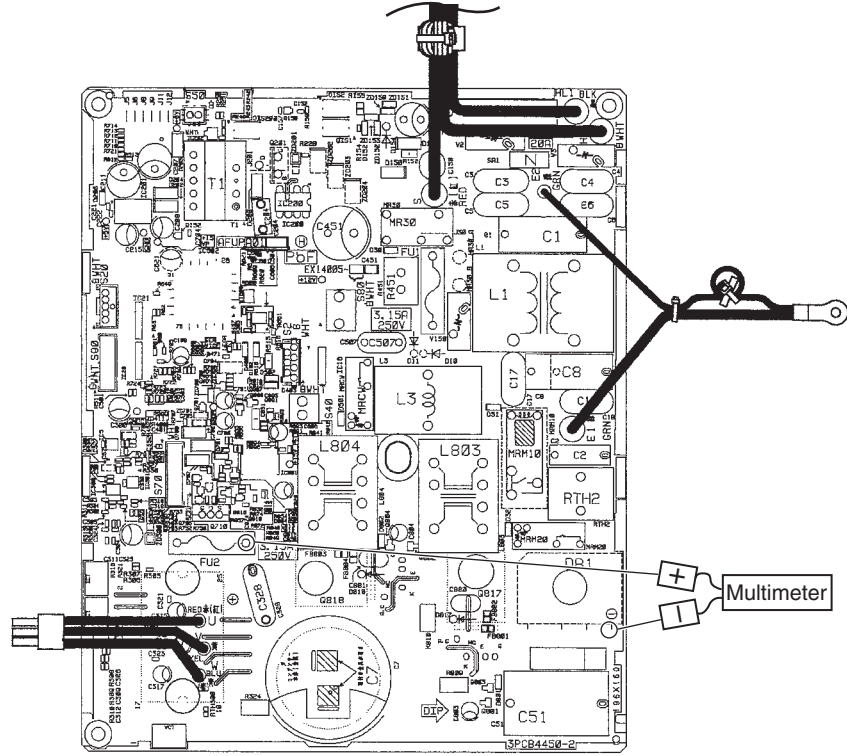

(R23024)

15 class

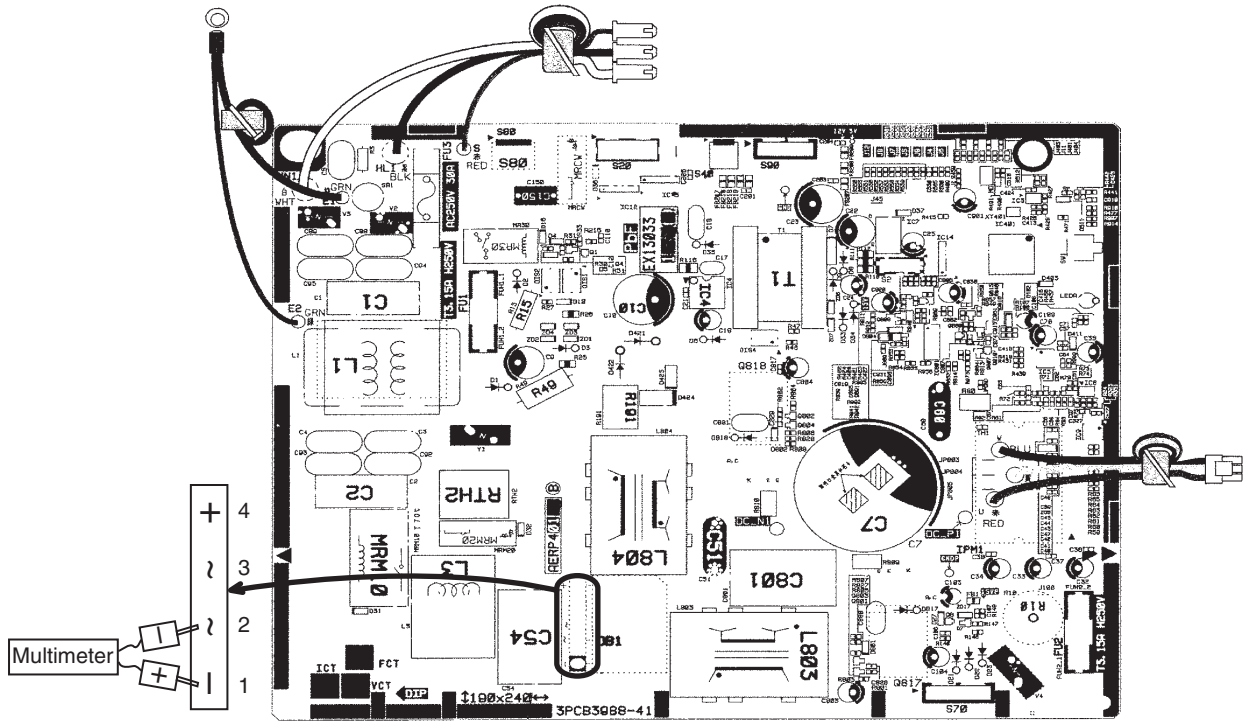

(R25105)

18/24 class

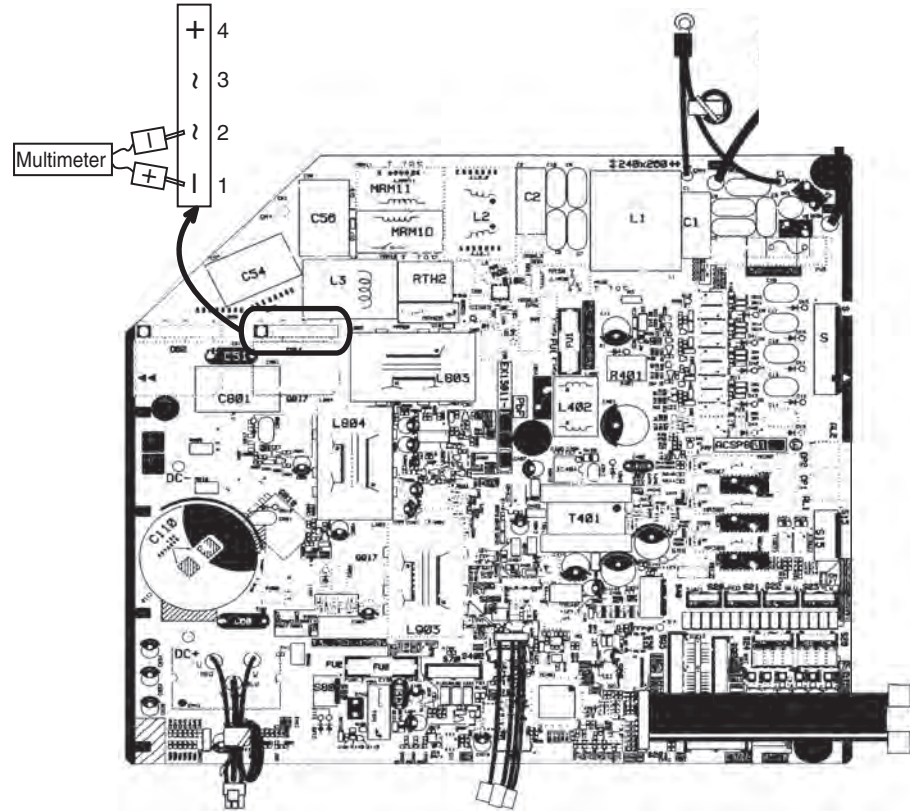

(R24538)

8.13 Power Module Check

Check No.22

Check to make sure that the voltage between (+) and (-) of the power module is about 0 V before checking.

- Disconnect the compressor harness connector from the outdoor unit PCB. To disengage the connector, press the protrusion on the connector.
- Follow the procedure below to measure resistance between the terminals of the power module and the terminals of the compressor with a multimeter. Evaluate the measurement results referring to the following table.

Positive terminal (+) of digital multimeter	Power module (+)	UVW	Power module (-)	UVW
Negative terminal (-) of digital multimeter	UVW	Power module (+)	UVW	Power module (-)
Resistance is OK.	several kΩ ~ several MΩ			
Resistance is NG.	0 Ω or ∞			

09 class

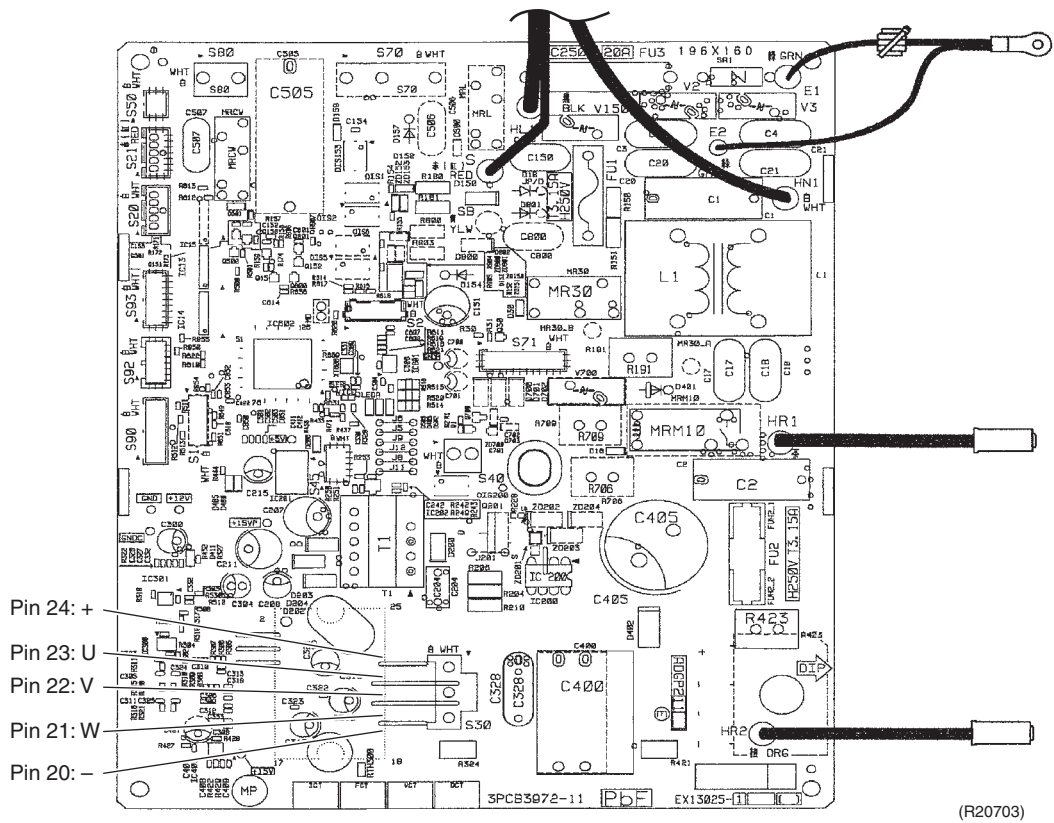

(R20703)

12 class

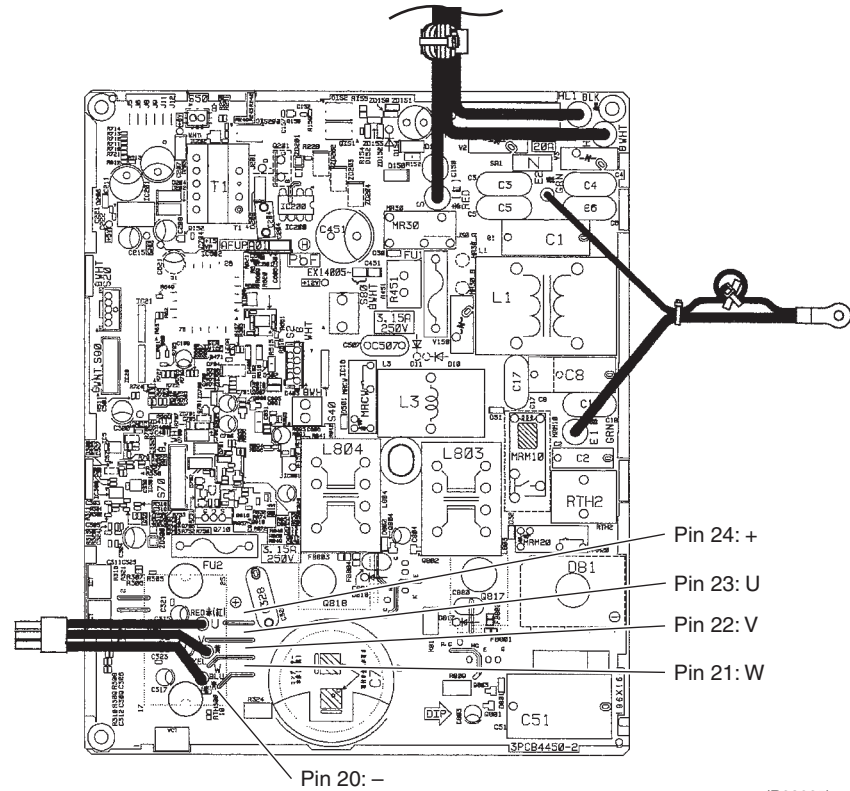

(R23025)

15 class

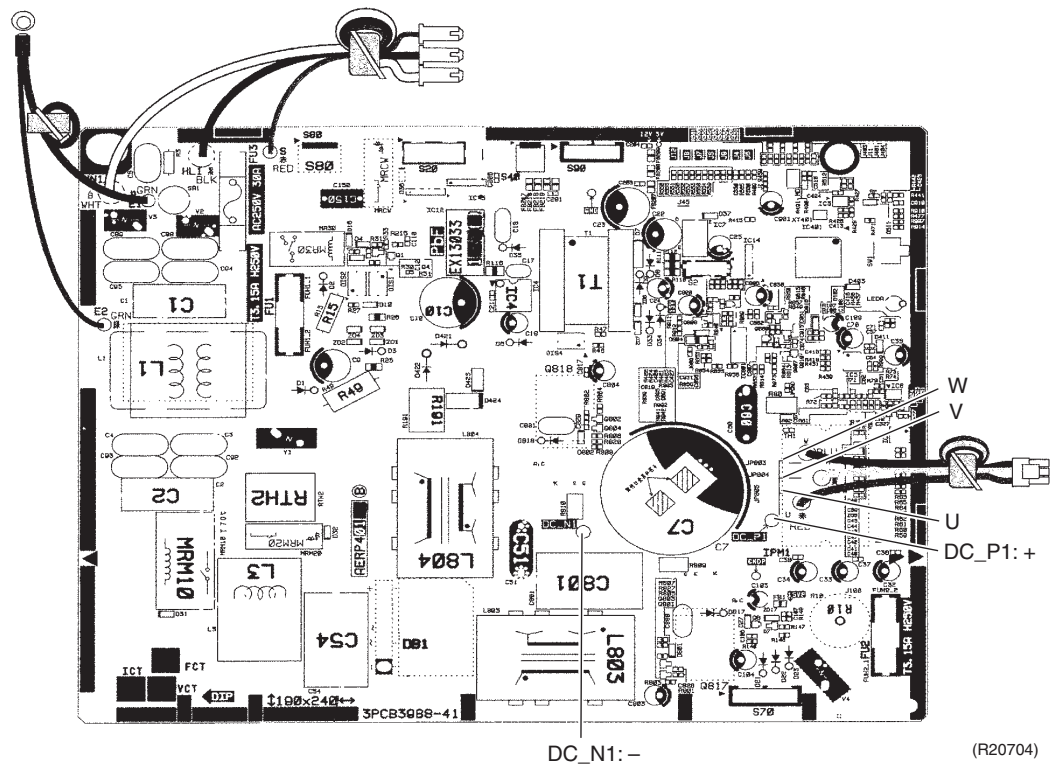

(R20704)

18/24 class

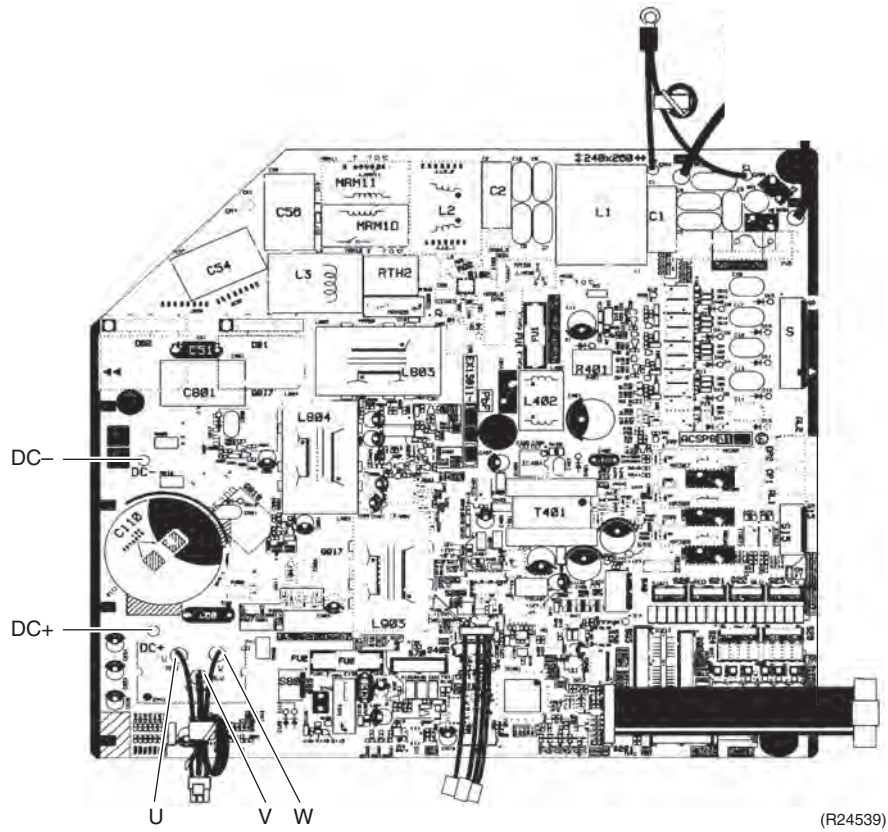

Part 7

Trial Operation and Field Settings

1. Pump Down Operation	198
2. Forced Cooling Operation	199
3. Trial Operation	202
4. Field Settings for FTX, FVXS Series	206
4.1 Temperature Display Switch	206
4.2 When 2 Units are Installed in 1 Room	207
4.3 Jumper and Switch Settings	209
5. Field Settings for FDMQ Series	210
5.1 How to Change the Field Settings	210
5.2 Overview of Field Settings	213
5.3 MAIN/SUB and Address Setting for Wireless Remote Controller	214
6. Field Settings for Outdoor Unit	217
6.1 Facility Setting (cooling at low outdoor temperature)	217
6.2 Drain Pan Heater	218
7. Silicone Grease on Power Transistor/Diode Bridge	219

1. Pump Down Operation

Outline

In order to protect the environment, be sure to conduct pump down operation when relocating or disposing of the unit.

Details

1. Remove the valve caps from the liquid stop valve and the gas stop valve.
2. Carry out forced cooling operation.
3. After 5 to 10 minutes, close the liquid stop valve with a hexagonal wrench.
4. After 2 to 3 minutes, close the gas stop valve and stop the forced cooling operation.

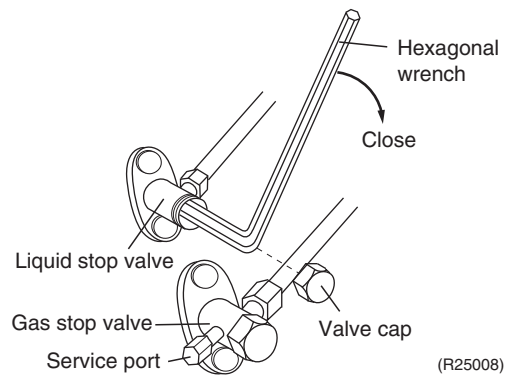

Reference

Refer to Forced Cooling Operation on page 199 for details.

2. Forced Cooling Operation

Outline

The forced cooling operation is allowed when both the following conditions are met.

1. The outdoor unit is not abnormal and not in the 3-minute standby mode.
2. The outdoor unit is not operating.

Protection functions have priority over all other functions during forced cooling operation.

Details

For FTX, FVXS series

■ With indoor unit ON/OFF switch

FTX09/12/15NMVJU

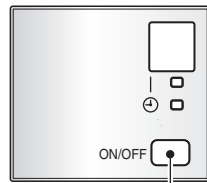

ON/OFF switch (SW1)

R7000271

FTX18/24UVJU

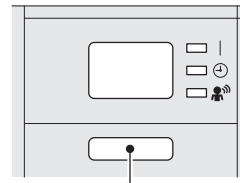

Indoor unit ON/OFF switch

R7000272

FVXS Series

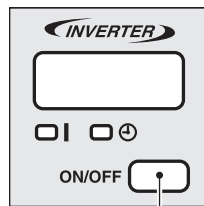

ON/OFF switch (SW1)

R7000273

■ **With remote controller**

FTX09/12/15NMVJU

1. Press center of **TEMP** button and **OFF** button at the same time.
2. Press **Temp**▲ button, select "7", and press **FAN** button.
3. Press **COOL** button to turn on the system.

Forced cooling operation will stop automatically after about 30 minutes.
To stop the operation, press **OFF** button.

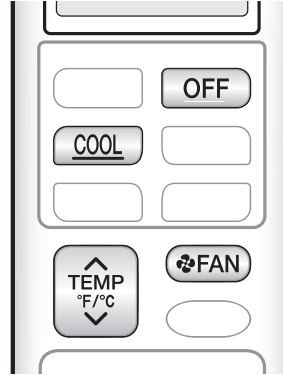

R7000274

FTX18/24UVJU, FVXS Series

1. Press **Mode** button and select the COOL operation.
2. Press **On/Off** button to turn on the system.
3. Press **Temp**▲, ▼ buttons and **Mode** button at the same time.
4. Press **Temp**▲, ▼ buttons, select "7", and press **Mode** button for confirmation.

Forced cooling operation will stop automatically after about 30 minutes.

To stop the operation, press **OFF** button.

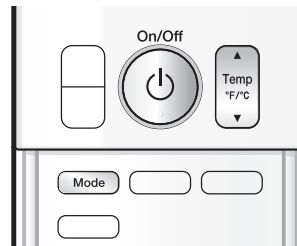

R7000275

For FDMQ series

■ **FDMQ Series with Wired Remote Controller (BRC1E73)**

1. Set to COOL operation using the remote controller.
 2. Press and hold **Cancel** button for 4 seconds or longer. Service settings menu is displayed.
 3. Select **Test Operation** in the service settings menu, and press **Menu/OK** button. Basic screen returns and “Test Operation” is displayed at the bottom.
 4. Press **On/Off** button within 10 seconds, and the forced cooling operation starts.
- ◆ Forced cooling operation will stop automatically after about 15 minutes. To stop the operation, press **On/Off** button.

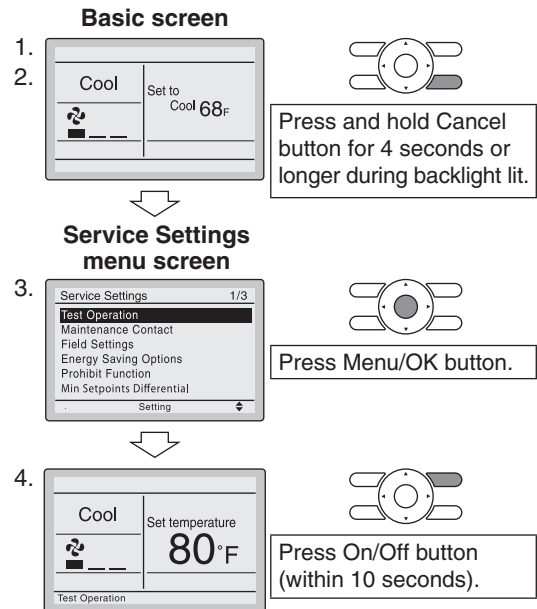

■ **FDMQ Series with Wireless Remote Controller (BRC082A43)**

1. Press button and select the COOL operation.
 2. Press button twice. “TEST” is displayed.
 3. Press button within 10 seconds, and the forced cooling operation starts.
- ◆ Forced cooling operation will stop automatically after about 15 minutes. To stop the operation, press button.

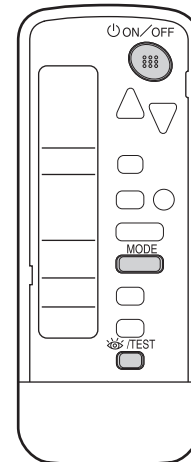

R7000276

3. Trial Operation

Outline

Carry out the trial operation in accordance with the operation manual to ensure that all functions and parts, such as flap movement, are working properly.

Trial operation should be carried out in either cooling or heating operation.

Procedure

1. Measure the power supply voltage and make sure that it falls within the specified range.
2. In cooling operation, select the lowest programmable temperature (18°C (64°F)); in heating operation, select the highest programmable temperature (30°C (86°F)).
 - Trial operation may be disabled in either operation mode depending on the room temperature.
 - After trial operation is complete, set the temperature to a normal level (26 ~ 28°C (78 ~ 82°F) in cooling, 20 ~ 24°C (68 ~ 75°F) in heating).
 - For protection, the system does not start for 3 minutes after it is turned off.

■ ARC480 Series

1. Press the center of **TEMP** button and **OFF** button on the remote controller at the same time.
2. Select \uparrow (trial operation) with **Temp** \wedge , or \vee button.
3. Press **FAN** button to enter the trial operation mode.
4. Press **COOL** or **HEAT** button to start trial operation.
5. Trial operation terminates in about 30 minutes and switches into normal mode. To quit trial operation, press **OFF** button.

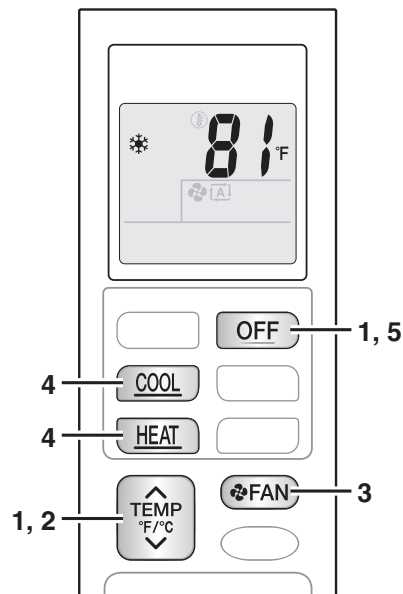

R7000277

■ ARC466 Series

1. Press **On/Off** button to turn on the system.
2. Press the center of **Temp** button and **Mode** button at the same time.
3. Select ? (trial operation) with **Temp ▲** or **Temp ▼** button.
4. Press **Mode** button to start the trial operation.
5. Press **Mode** button and select operation mode.
6. Trial operation terminates in about 30 minutes and switches into normal mode.
To quit trial operation, press **On/Off** button.

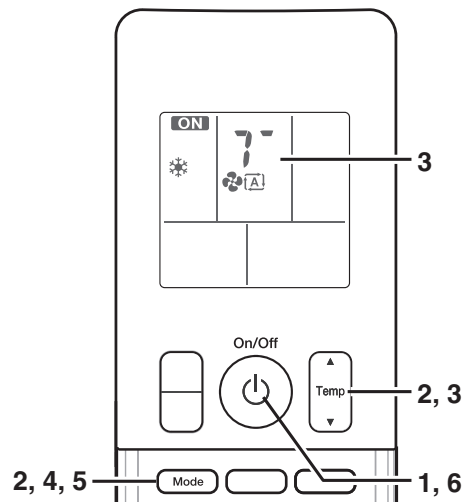



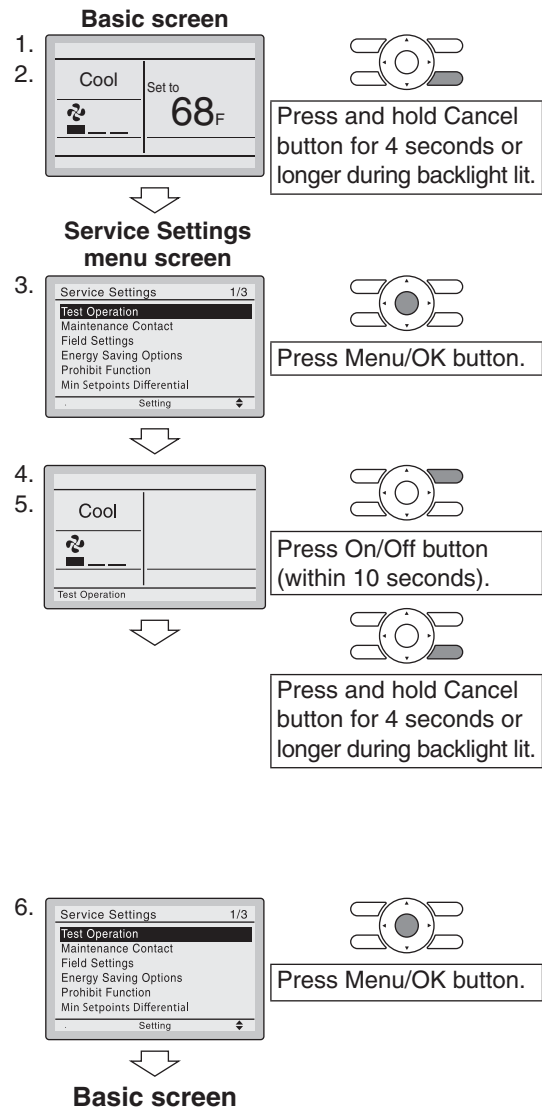

R7000147

■ Wired Remote Controller (BRC1E73)

1. Set to COOL or HEAT operation using the remote controller.
2. Press and hold **Cancel** button for 4 seconds or longer. Service settings menu is displayed.
3. Select **Test Operation** in the service settings menu, and press **Menu/OK** button. Basic screen returns and “Test Operation” is displayed at the bottom.
4. Press **On/Off** button within 10 seconds, and the test operation starts.
Monitor the operation of the indoor unit for a minimum of 10 minutes. During test operation, the indoor unit will continue to cool/heat regardless of the temperature setpoint and room temperature.
 - ◆ In the case of above-mentioned procedures 3 and 4 in reverse order, test operation can start as well.
5. Press and hold **Cancel** button for 4 seconds or longer in the basic screen. Service settings menu is displayed.
6. Select **Test Operation** in the service settings menu, and press **Menu/OK** button. Basic screen returns and normal operation is conducted.
 - ◆ Test operation will stop automatically after 15 ~ 30 minutes. To stop the operation, press **On/Off** button.



■ Wireless Remote Controller (BRC082A43)

1. Press  button and select the COOL or HEAT operation.
2. Press  button twice. “TEST” is displayed.
3. Press  button within 10 seconds, and the test operation starts.
Monitor the operation of the indoor unit for a minimum of 10 minutes. During test operation, the indoor unit will continue to cool/heat regardless of the temperature setpoint and room temperature.
 - ◆ In the case of above-mentioned procedures (1) and (2) in reverse order, test operation can start as well.
 - ◆ Test operation will stop automatically after 15 ~ 30 minutes.
To stop the operation, press  button.
 - ◆ Some of the functions cannot be used in the test operation mode.

Test Items

Test items	Symptoms
Indoor and outdoor units are installed securely.	Fall, vibration, noise
Is the outdoor unit fully installed?	No operation or burn damage
No refrigerant gas leaks.	Incomplete cooling/heating function
Refrigerant gas and liquid pipes and indoor drain hose extension are thermally insulated.	Water leakage
Draining line is properly installed.	Water leakage
Does the power supply voltage correspond to that shown on the name plate?	No operation or burn damage
Only specified wires are used for all wiring, and all wires are connected correctly.	No operation or burn damage
System is properly grounded.	Electrical leakage
Is wiring size according to specifications?	No operation or burn damage
Is something blocking the air outlet or inlet of either the indoor or outdoor units?	Incomplete cooling/heating function
Are refrigerant piping length and additional refrigerant charge noted down?	The refrigerant charge in the system is not clear
Pipes and wires are connected to the corresponding connection ports/terminal blocks for the connected unit.	No cooling/heating
Stop valves are opened.	Incomplete cooling/heating function
Check that the connector of the lead wires of the decoration panel is connected securely.	Louvers do not move
Indoor unit properly receives wireless remote control commands.	No operation

4. Field Settings for FTX, FVXS Series

4.1 Temperature Display Switch

ARC480 Series

- You can select Fahrenheit or Celsius for temperature display.
- Press **TEMP** \wedge button and **ON TIMER** buttons simultaneously for 5 seconds to change the unit of temperature display.
- You can also change the unit of temperature display by pressing **Temp** \wedge and \vee buttons simultaneously for 5 seconds.

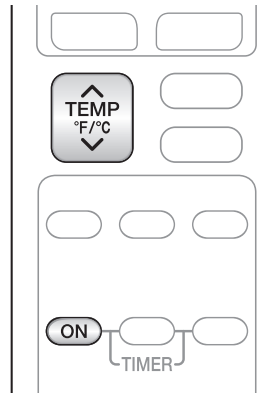

(R14477)

ARC466 Series

- Press the upper side of **Temp** button and **On** button at the same time for 5 seconds to change the unit of temperature display.

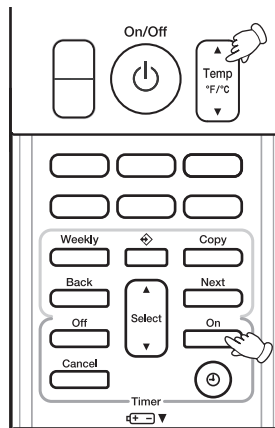

(R22009)

4.2 When 2 Units are Installed in 1 Room

Outline

When 2 indoor units are installed in 1 room, 1 of the 2 indoor units and the corresponding wireless remote controller can be set for different address.

FTX09/12/15NMV JU

1. Remove the battery cover of the remote controller.
2. Cut the address jumper.
3. Press the center of **TEMP** button and **OFF** switch on the remote controller at the same time.
4. Select \mathcal{R} (address setting) with **TEMP** \wedge or **TEMP** \vee button.
5. Press **FAN** button to enter the address setting mode.
The indoor unit operation lamp blinks for 1 minute.
6. Press indoor unit **ON/OFF** switch while the operation lamp is blinking.
7. Press **FAN** button on the remote controller for 5 seconds to return to the normal mode.

Wireless Remote Controller

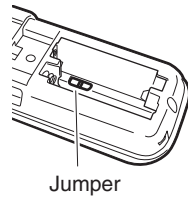

Jumper	Address
EXIST	1
CUT	2

R7000281

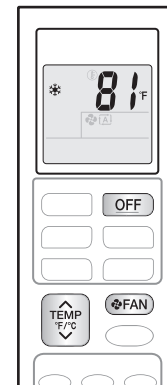

R7000282

Indoor Unit

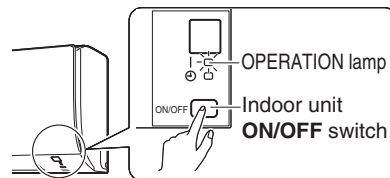

R7000283



Caution

Replace the remote controller if you cut a jumper unintentionally.

Jumpers are necessary for electronic circuit. Improper operation may occur if you cut any of them.

FTX18/24UVJU

1. Remove the front grille.
2. Remove the electrical box.
3. Remove the shield plate of the electrical box.
4. Cut the address setting jumper JA on the PCB.
5. Remove the cover of remote controller battery.
6. Cut the address setting jumper J4.

Indoor unit PCB

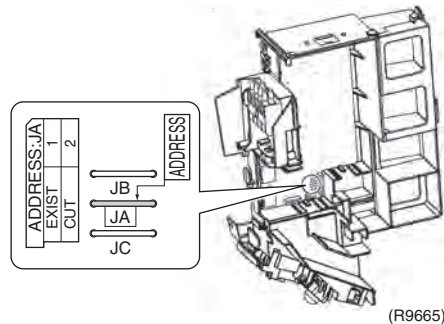

Wireless Remote Controller

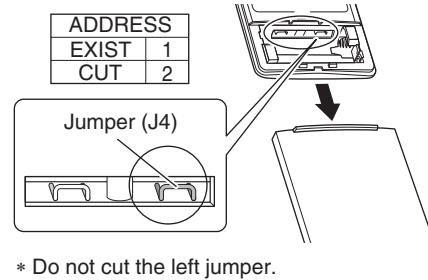

R7000284

**Caution****Replace the PCB if you cut a jumper unintentionally.**

Jumpers are necessary for electronic circuit. Improper operation may occur if you cut any of them.

**Caution****Replace the remote controller if you cut a jumper unintentionally.**

Jumpers are necessary for electronic circuit. Improper operation may occur if you cut any of them.

FVXS Series

1. Remove the electrical wiring box.
2. Cut the address jumper (JA) on the printed circuit board.
3. Cut the address jumper (J4) in the remote controller.
4. Attach the electrical wiring box as they were.
5. Attach the front panel and the front grille as they were.

Indoor Unit PCB

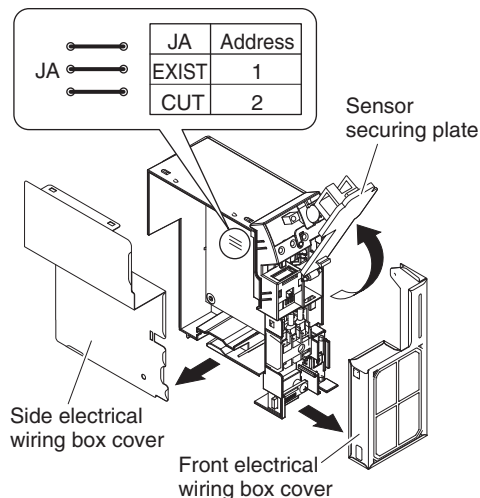

Wireless Remote Controller

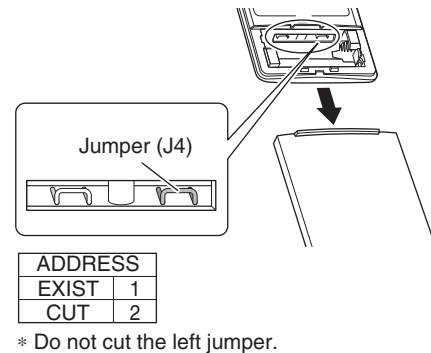

(R18416)

R7000286

**Caution****Replace the PCB if you cut a jumper unintentionally.**

Jumpers are necessary for electronic circuit. Improper operation may occur if you cut any of them.

**Caution****Replace the remote controller if you cut a jumper unintentionally.**

Jumpers are necessary for electronic circuit. Improper operation may occur if you cut any of them.

4.3 Jumper and Switch Settings

Jumper for FTX18/24UVJU, FVXS series

Jumper on indoor unit PCB	Function	When connected (factory setting)	When cut
JB	Fan speed setting when compressor stops for thermostat OFF. (effective only at cooling operation)	Fan speed setting; Remote controller setting	The fan stops.
JC	Power failure recovery function	Auto-restart	The unit does not resume operation after recovering from a power failure. Timer settings are cleared.

Switch for FVXS series

Switch on indoor unit PCB	Function	OFF (factory setting)	ON
SW2-4	Upward airflow limit setting	Exposed or half embedded installation	Set the switch to ON position when you install the indoor unit embedded in the wall to avoid condensation.

**Reference**

For the location of the jumper and the switch, refer to the following pages.

FTX18/24UVJU: page 26

FVXS: page 28

5. Field Settings for FDMQ Series

5.1 How to Change the Field Settings

Outline

If optional accessories are mounted on the indoor unit, the indoor unit setting may have to be changed. Refer to the instruction manual for each optional accessory.



Note

When using 2 remote controllers for 1 indoor unit, change the field settings from MAIN remote controller. Note that the field settings can not be set from SUB remote controller.

Procedure

BRC1E73 Wired Remote Controller

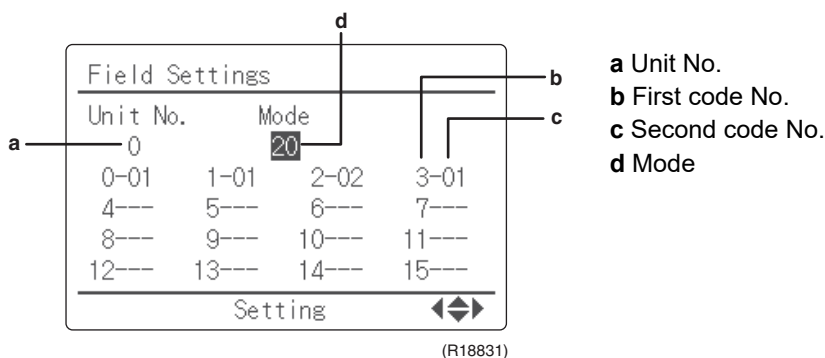

1. Press and hold **Cancel** button for 4 seconds or longer.
Service settings menu is displayed.

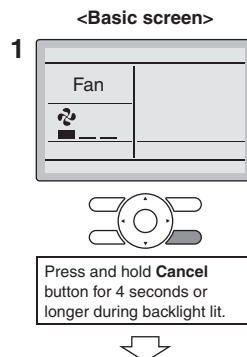

2. Select **Field Settings** in the Service Settings menu, and press **Menu/OK** button.
Field settings screen is displayed.

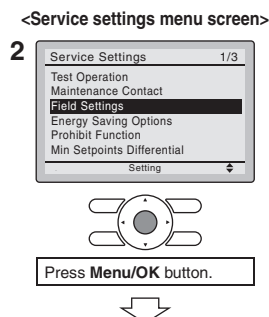

3. Highlight the mode, and select desired "Mode No." by using ▲ ▼ (Up/Down) button.
4. In the case of setting per indoor unit during group control (When Mode No. such as 20, 22, 23, 25 are selected), highlight the unit No. and select "Indoor unit No." to be set by using ▲ ▼ (Up/Down) button. (In the case of group setting, this operation is not needed.)

[In the case of individual setting per indoor unit, current settings are displayed. And, SECOND CODE NO. " - " means no function.]

5. Highlight SECOND CODE NO. of the FIRST CODE NO. to be changed, and select desired "SECOND CODE NO." by using ▲ ▼ (Up/Down) button. Multiple identical mode number settings are available.

[In the case of setting for all indoor units in the remote control group, available SECOND CODE NO. is displayed as " * " which means it can be changed. When SECOND CODE NO. is displayed as " - ", there is no function.]

<Service settings screen>

In the case of individual setting per indoor unit

3
4
5

In the case of group total setting

3
5

SECOND CODE NO.
FIRST CODE (SW) NO.



Press Menu/OK button.

6. Press **Menu/OK** button. Setting confirmation screen is displayed.
7. Select **Yes** and press **Menu/OK** button. Setting details are determined and field settings screen returns.
8. In the case of multiple setting changes, repeat 3 to 7.
9. After all setting changes are completed, press **Cancel** button twice.
10. Backlight goes out, and [Checking the connection. Please stand by.] is displayed for initialization. After the initialization, the basic screen returns.



<Setting confirmation screen>

6
7



Press Menu/OK button.



Setting confirmation



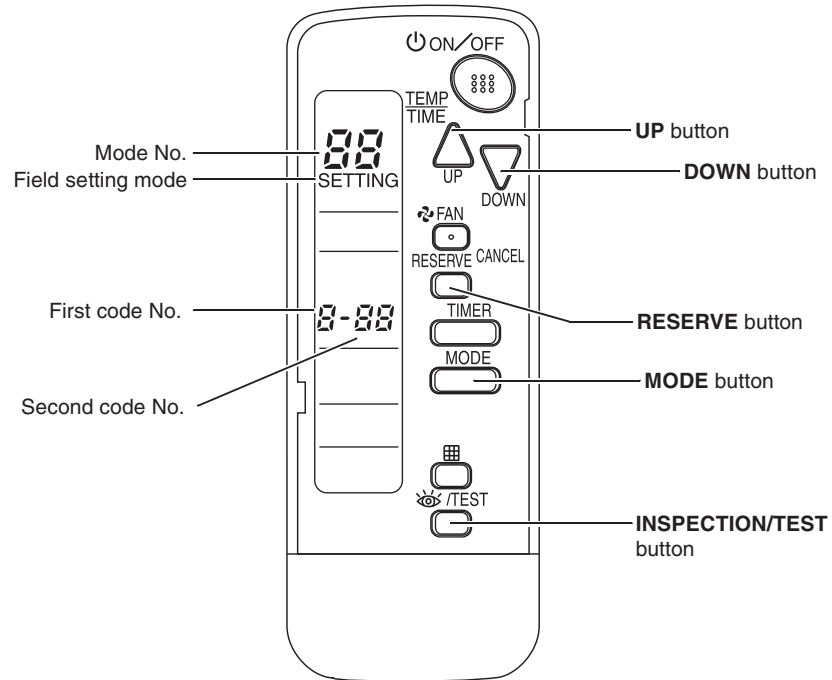

BRC082A43 Wireless Remote Controller



R7000287

To set the field settings, you have to change:

- Mode No.
- First code No.
- Second code No.

1. When in normal mode, hold down /TEST button for at least 4 seconds to enter the Field Set mode.
2. Select the desired Mode No. with **MODE** button.
3. Press  button and select the First code No.
4. Press  button and select the Second code No.
5. Press **RESERVE** button to confirm the settings.
6. Press /TEST button to quit the Field Set mode and to return to normal display again.

5.2 Overview of Field Settings

Mode No.	First Code No.	Second Code No.			Description of setting			
		01	02	03				
10 (20)	0	Light★	Approx. 2,500 hrs.★	Heavy	Approx. 1,250 hrs.	—	Filter cleaning sign interval (used to change filter cleaning display interval according to filter contamination)	Longlife filter
			Approx. 200 hrs.★		Approx. 100 hrs.			Standard filter
	3	Display★	No display	—	Filter cleaning sign (used to set filter cleaning display ON/OFF)			
11 (21)	7	OFF★	Air volume adjustment completion	Air volume adjustment start	Air volume adjustment			

★ Factory Setting



Note(s)

- The Second Code No. is factory set to "01".
- Do not use any settings not listed in the table.
- For group control with a wireless remote controller, initial settings for all the indoor units of the group are equal.
For group control, refer to the installation manual attached to the indoor unit for group control.

External Static Pressure Settings

12 class

Mode No.	First Code No.	Second Code No.	External static pressure
13 (23)	6	03	30 Pa
		04	40 Pa
		05 ★	50 Pa ★
		06	60 Pa
		07	70 Pa
		08	80 Pa
		09	90 Pa
		10	100 Pa
		11	110 Pa
		12	120 Pa
		13	130 Pa
		14	140 Pa
		15	150 Pa

★ Factory Setting

18/24 class

Mode No.	First Code No.	Second Code No.	External static pressure
13 (23)	6	05 ★	50 Pa ★
		06	60 Pa
		07	70 Pa
		08	80 Pa
		09	90 Pa
		10	100 Pa
		11	110 Pa
		12	120 Pa
		13	130 Pa
		14	140 Pa
		15	150 Pa

★ Factory Setting

5.3 MAIN/SUB and Address Setting for Wireless Remote Controller

Outline

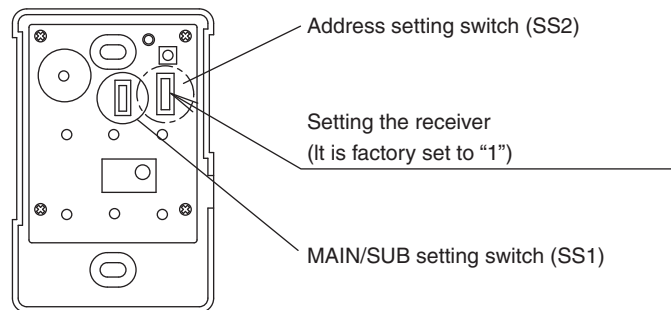

- If setting multiple wireless remote controllers to operate in one room, perform address setting for the receiver and the wireless remote controller.
- If using both a wired remote controller and a wireless remote controller with 1 indoor unit, change the MAIN/SUB switch of the signal receiver PCB.

Signal Receiver PCB Setting

(R24951)

MAIN/SUB switch

Set the MAIN/SUB setting switch (SS1) on the signal receiver PCB to SUB.

	MAIN	SUB
MAIN/SUB setting switch (SS1)	 R7000181	 R7000182

Wireless address switch

Set the address setting switch (SS2) on the signal receiver PCB according to the table below.

	No.1	No.2	No.3
Address setting switch (SS2)	 R7000183	 R7000184	 R7000185

Wireless Remote Controller Address

Factory set is 1. Change the wireless remote controller address setting by the following steps, if necessary.

1. Hold down button and /TEST button at the same time for at least 4 seconds to enter the field setting mode. (SETTING is indicated on the display).
2. Press button and select display setting (or). Each time the button is pressed, the display switches between and .
3. Press button and button to set the address.

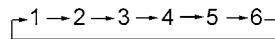

Address can be set from 1 ~ 6, but set it to 1 ~ 3 and to same address as the receiver. The receiver does not work with address 4 ~ 6.

4. Press **RESERVE** button to confirm the setting.
5. Hold down /TEST button to quit the field setting mode and return to the normal display.

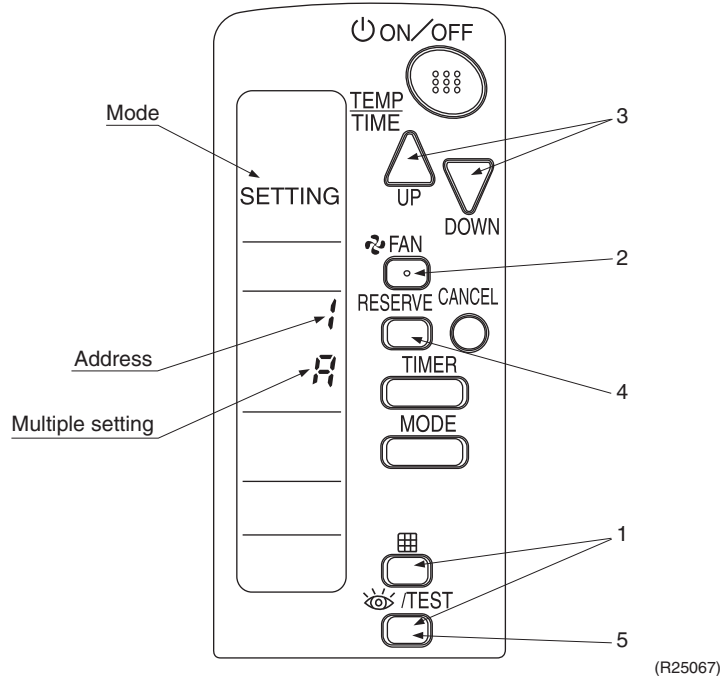

Multiple Settings

⌘ or ⌘

When the indoor unit is controlled by an outside controller (central remote controller, etc.), the indoor unit sometimes does not respond to ON/OFF command or temperature setting command from the wireless remote controller. Check what setting the customer needs and make the multiple setting as shown below.

Remote Controller		Indoor Unit	
Multiple settings	Remote controller display	To control other air conditions and units	For other than on left
⌘: Standard	All items displayed.	Commands other than ON/OFF and temperature setting accepted. (1 LONG BEEP or 3 SHORT BEEPS emitted)	All commands accepted. (2 SHORT BEEPS)
⌘: Multi System	Operations remain displayed shortly after execution	All commands accepted. (2 SHORT BEEPS)	

After Setting

Stick the Unit No. label on the receiver and the back of the wireless remote controller.

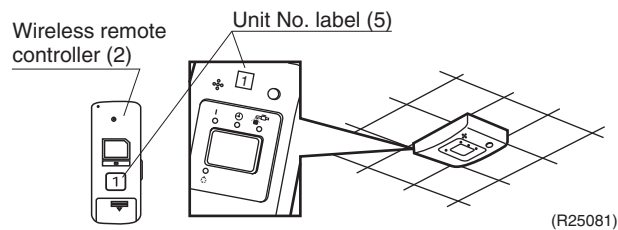
**Note(s)**

Set the Unit No. of the receiver and the wireless remote controller to be the equal. If the settings differ, the signal from the remote controller cannot be transmitted.

6. Field Settings for Outdoor Unit

6.1 Facility Setting (cooling at low outdoor temperature)

Outline

This function is limited only for facilities (the target of air conditioning is equipment such as computers). Never use it in a residence or office (the space where there is a human).

Details

■ 09/12/15 class

Cutting jumper 6 (J6) on the circuit board will expand the operation range down to 5°F (−15°C). However it will stop if the outdoor temperature drops below −4°F (−20°C) and start back up once the temperature rises again.

- (1) Remove the top plate of the outdoor unit. (09/12 class: 3 screws, 15 class: 6 screws)
- (2) Remove the front plate. (09/12 class: 4 screws, 15 class: 8 screws)
- (3) Cut the jumper (J6) of the PCB inside.

■ 18/24 class

Turning on SW5-3 on the PCB will extend the operation range to 14°F (−10°C). Installing an air direction adjustment grille (sold separately) will further extend the operation range to −4°F (−20°C). In these cases, the unit will stop operating if the outdoor temperature falls below −4°F (−20°C), restarting once the temperature rises above this level.

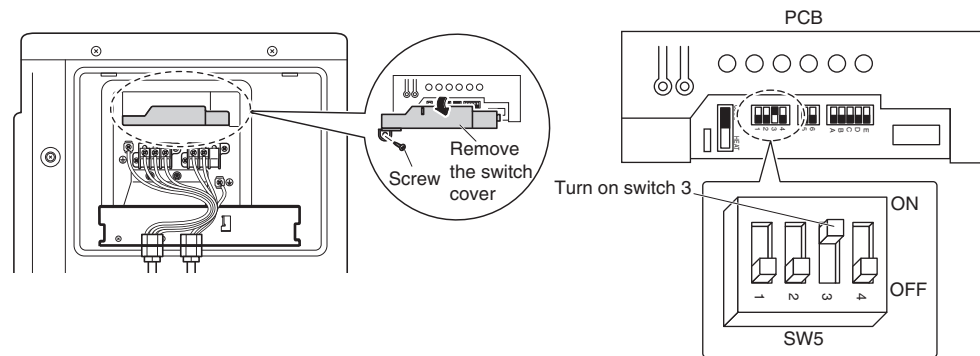

R7000285



Reference

For the location of the jumper, refer to pages 34, 36, 38.



Caution

Replace the PCB if you cut a jumper unintentionally.

Jumpers are necessary for electronic circuit. Improper operation may occur if you cut any of them.



Caution

- If the outdoor unit is installed where the heat exchanger of the unit is exposed to direct wind, provide a windbreak wall.
- Intermittent noises may be produced by the indoor unit due to the outdoor fan turning on and off when using facility settings.
- Do not place humidifiers or other items which might raise the humidity in rooms where facility settings are being used.
A humidifier might cause dew jumping from the indoor unit outlet vent.
- Cutting jumper sets the indoor fan tap to the highest position.

6.2 Drain Pan Heater

When attaching the drain pan heater

1. Attach the drain pan heater in accordance with the installation manual included with the drain pan heater.
2. Turn on SW6-1 on the PCB.

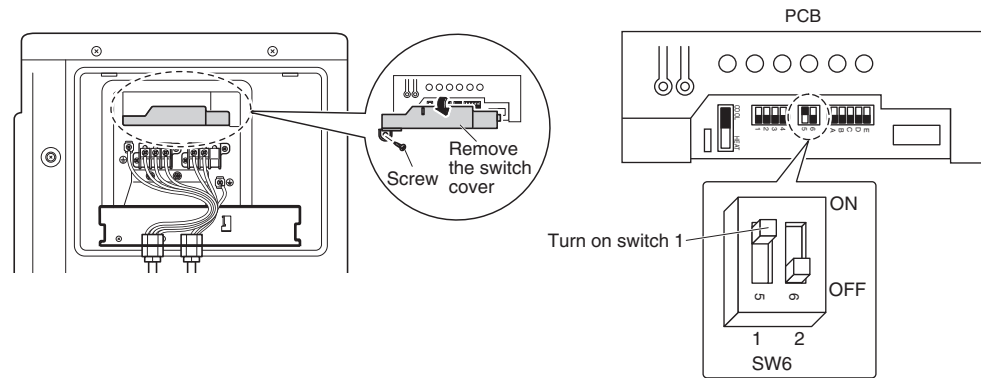

R7000288

7. Silicone Grease on Power Transistor/Diode Bridge

Outline

Apply the specified silicone grease to the heat radiation part of a power transistor/diode bridge when you replace an outdoor unit PCB. The silicone grease encourages the heat radiation of a power transistor/diode bridge.

Details

1. Wipe off the old silicone grease completely.
2. Apply the silicone grease evenly. See the illustrations below for examples of application.
3. Tighten the screws of the power transistor/diode bridge.
4. Make sure that the heat radiation parts are firmly contacted to the radiation fin.

Note: Smoke emission may be caused by bad heat radiation when the silicone grease is not appropriately applied.

- OK: Evenly applied

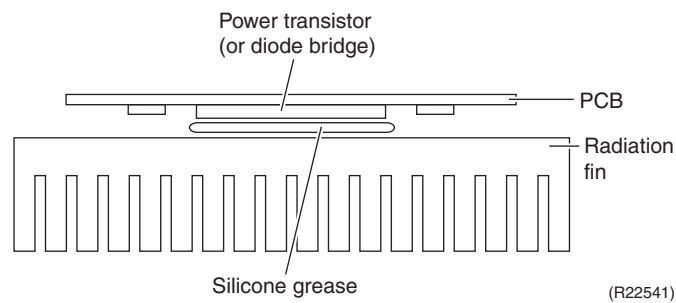

- NG: Not evenly applied

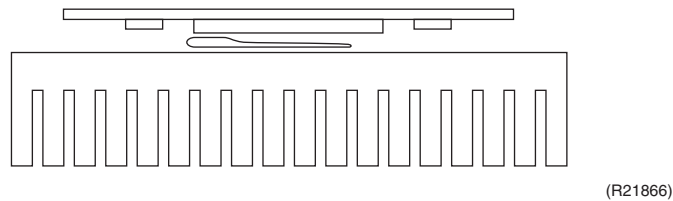

- NG: Foreign matter is stuck.

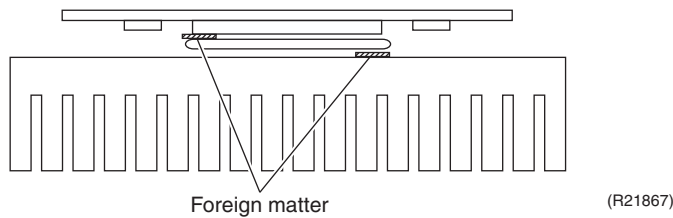

Part 8 Appendix

1. Piping Diagrams.....	221
1.1 Indoor Unit.....	221
1.2 Outdoor Unit.....	223
2. Wiring Diagrams.....	226
2.1 Indoor Unit.....	226
2.2 Outdoor Unit.....	231
3. Operation Limit.....	236

1. Piping Diagrams

1.1 Indoor Unit

FTX09/12NMVJU

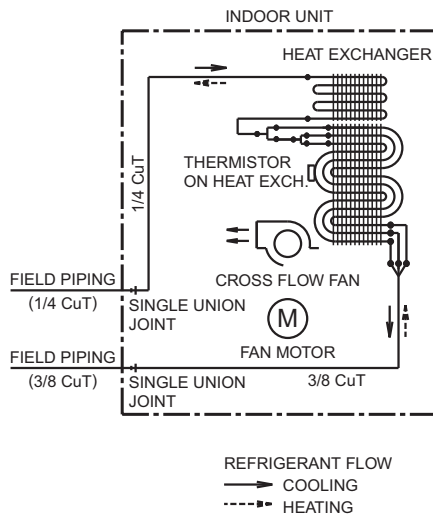

4D091708A

FTX15NMVJU

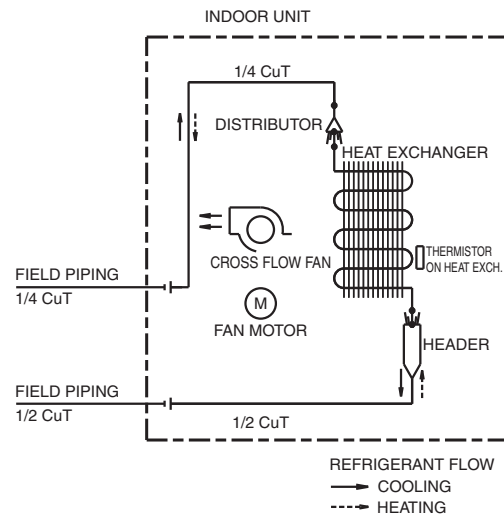

4D091769C

FTX18UVJU

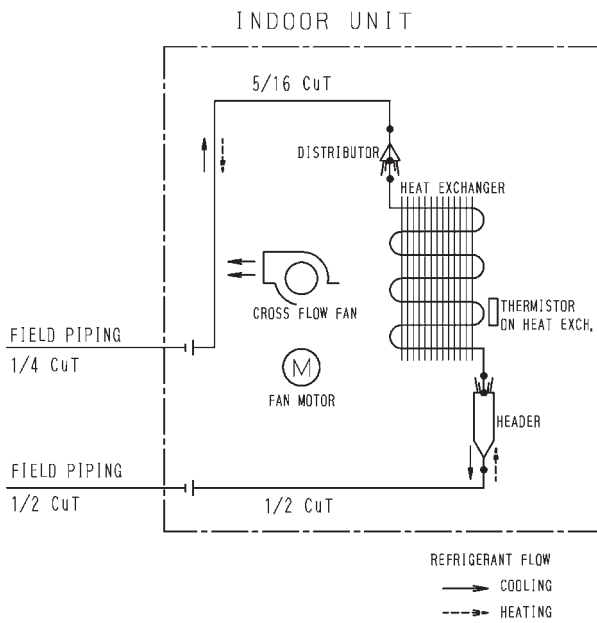

4D074609A

FTX24UVJU

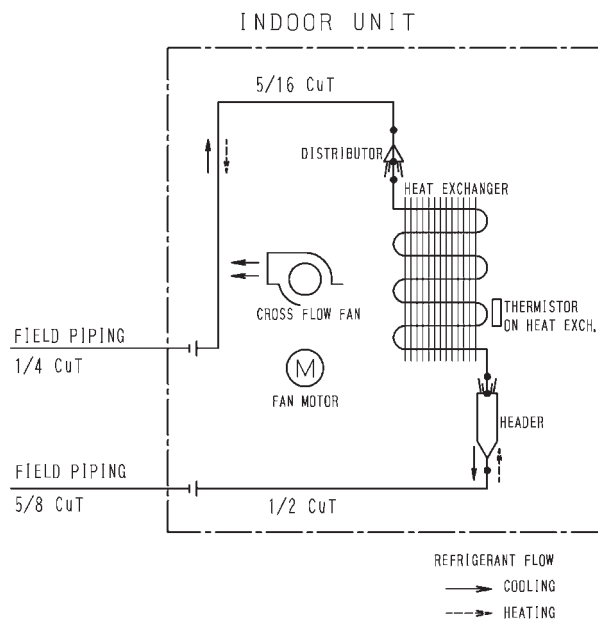

4D074608A

FVXS09/12NVJU

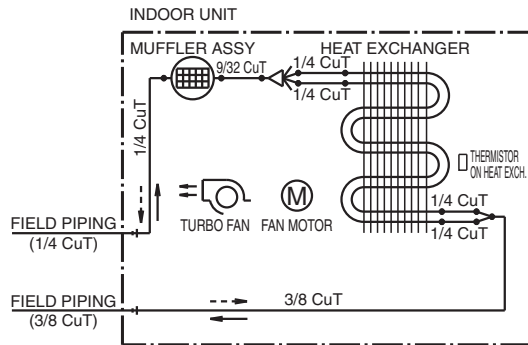

REFRIGERANT FLOW
 —> COOLING
 - -> HEATING

4D091794

FVXS15NVJU

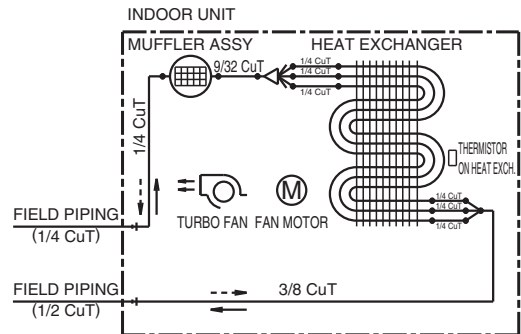

REFRIGERANT FLOW
 —> COOLING
 - -> HEATING

4D091795A

FDMQ12/18/24RVJU

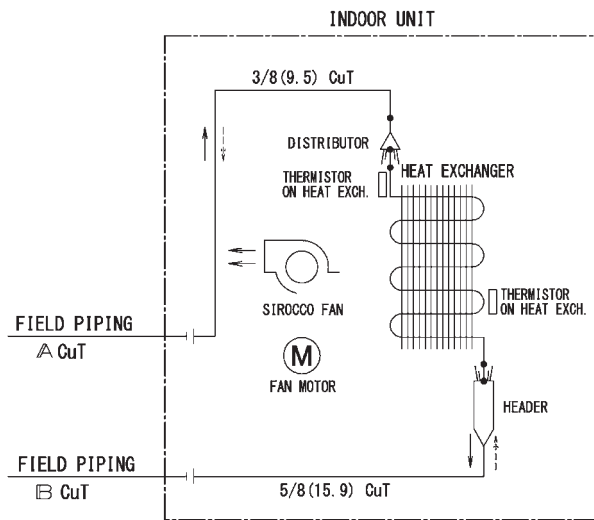

REFRIGERANT FLOW
 —> COOLING
 - -> HEATING

MODEL	A	B
FDMQ12RVJU	1/4 (6.4)	3/8 (9.5)
FDMQ18RVJU	1/4 (6.4)	1/2 (12.7)
FDMQ24RVJU	1/4 (6.4)	5/8 (15.9)

C: 4D112974A

1.2 Outdoor Unit

RXL09QMVJU

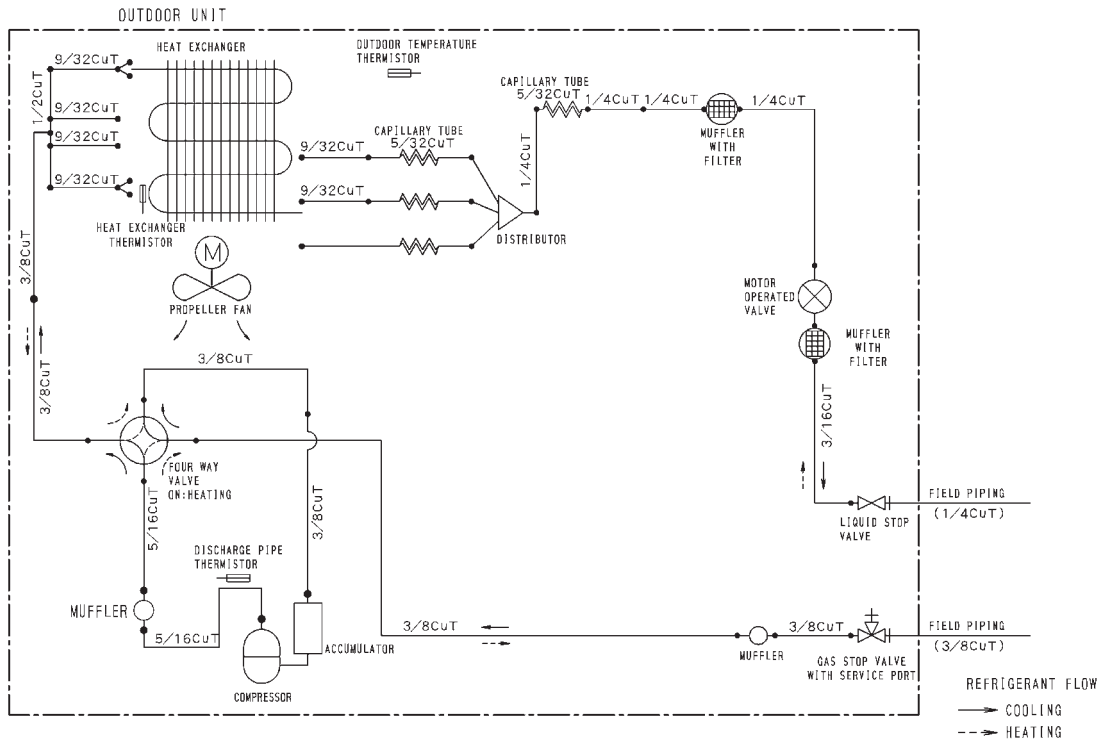

RXL12QMVJU(9)

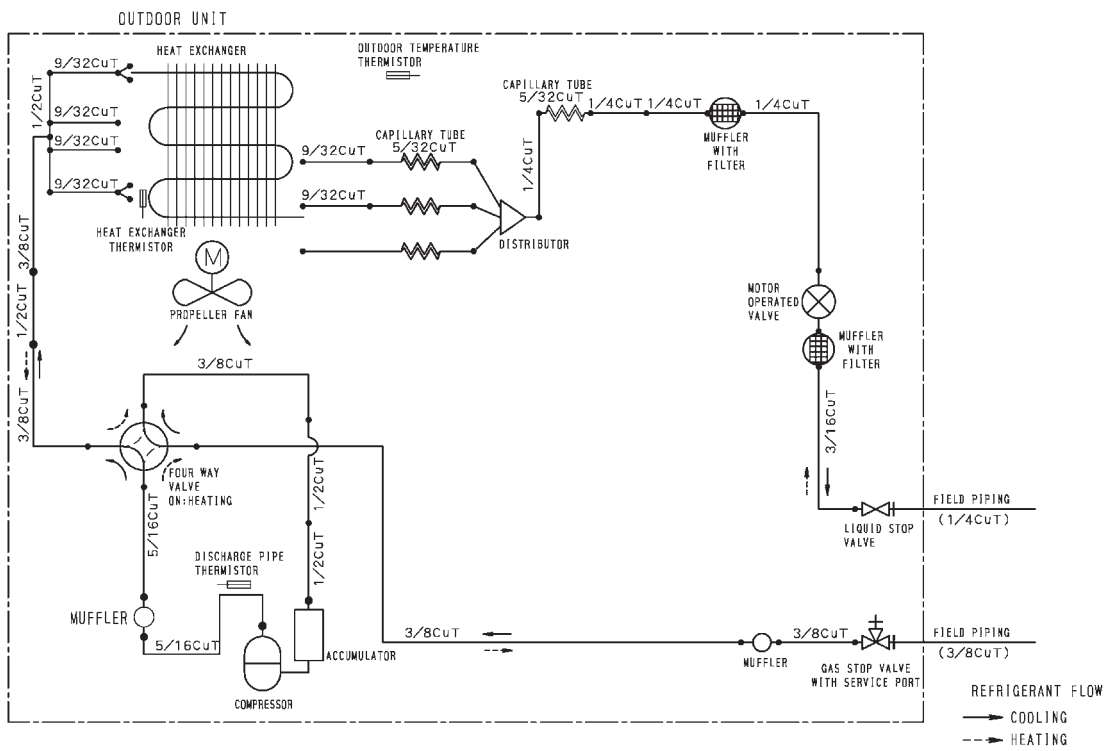

RXL15QMVJU

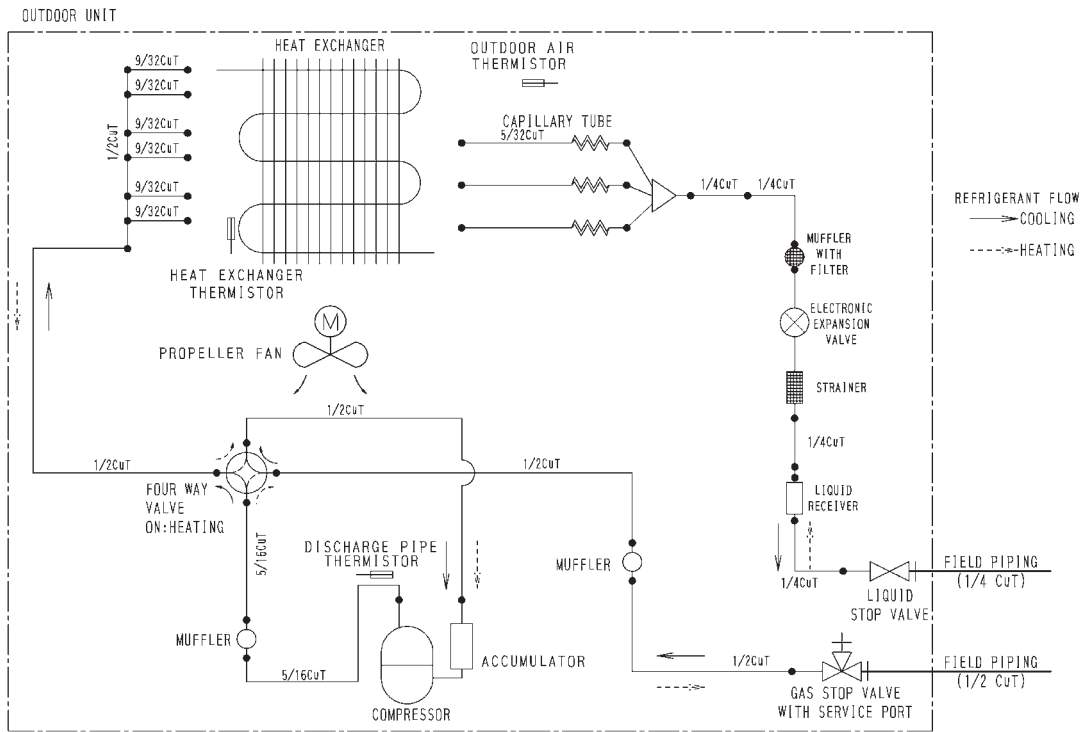

3D100007

RXL18UMVJU

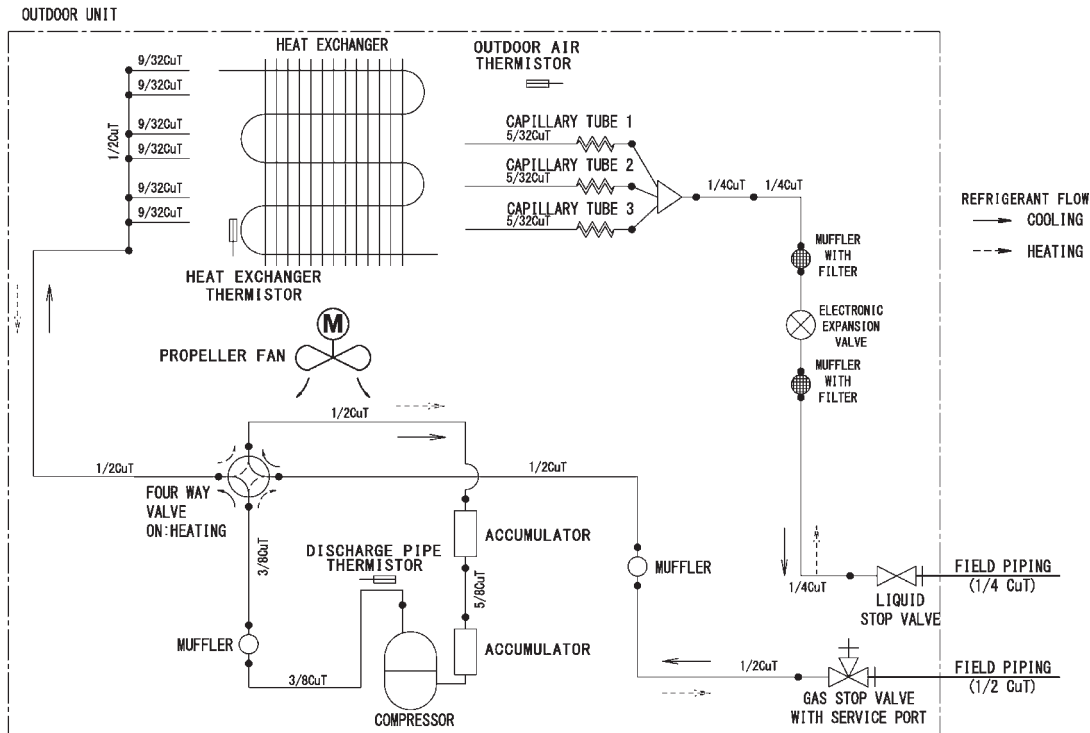

3D123368

RXL24UMVJU

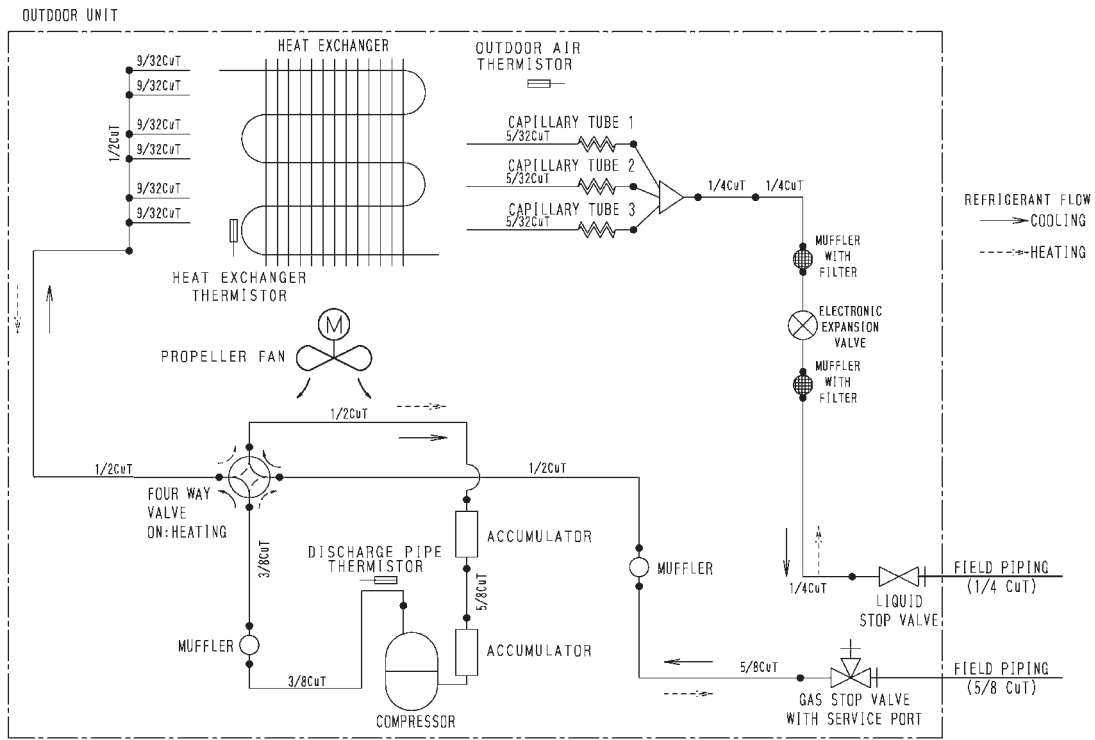

2. Wiring Diagrams

2.1 Indoor Unit

FTX09/12NMVJU

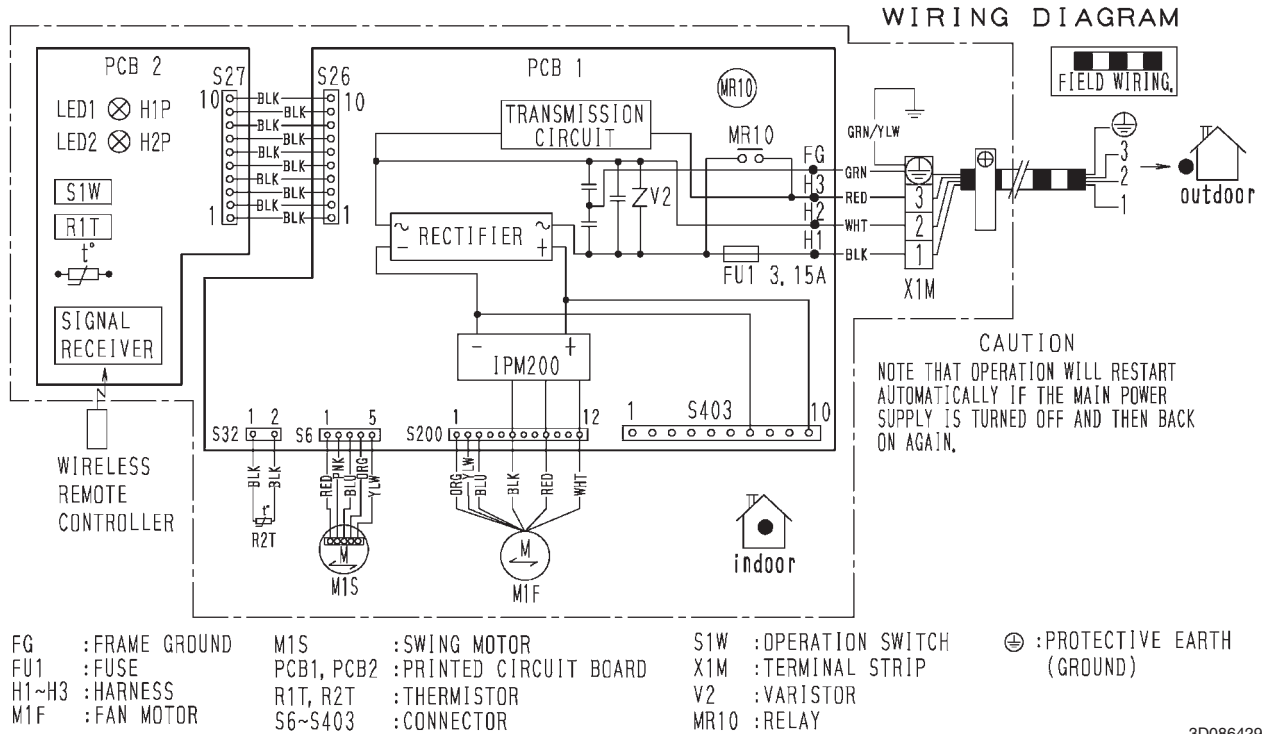

Note(s)

PCB1: Control PCB

PCB2: Display/signal receiver PCB

Refer to page 22 for Printed Circuit Board Connector Wiring Diagram.

FTX15NMVJU

WIRING DIAGRAM

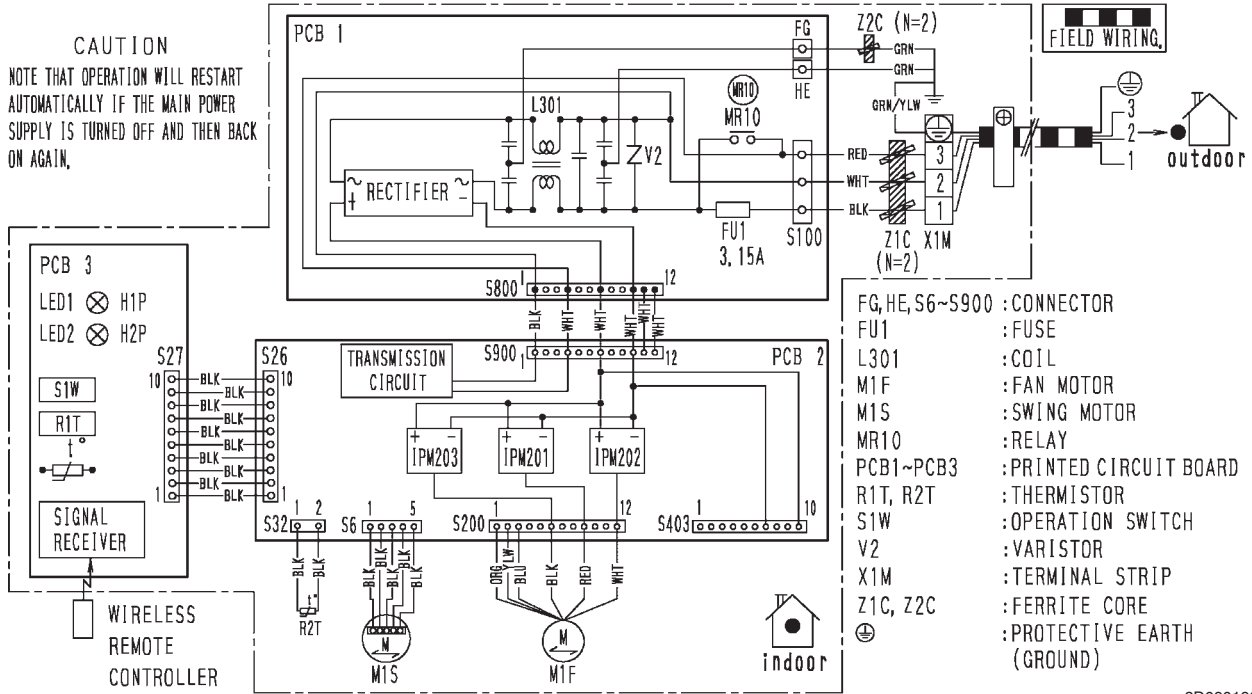

3D090199B



Note(s)

- PCB1: Filter PCB
- PCB2: Control PCB
- PCB3: Display/signal receiver PCB
- Refer to page 24 for Printed Circuit Board Connector Wiring Diagram.

FTX18/24UVJU

WIRING DIAGRAM

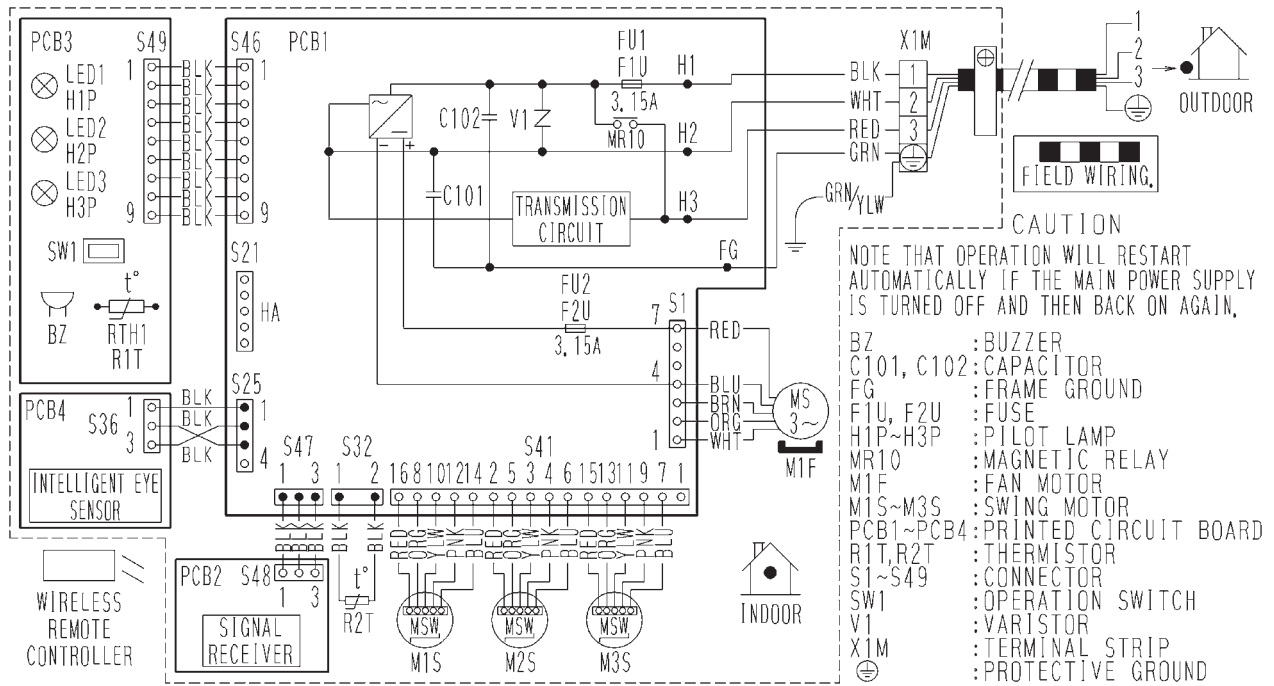

C: 3D060942W



Note(s)

- PCB1: Control PCB
- PCB2: Signal receiver PCB
- PCB3: Display PCB
- PCB4: INTELLIGENT EYE sensor PCB
- Refer to page 26 for Printed Circuit Board Connector Wiring Diagram.

FVXS09/12/15NVJU

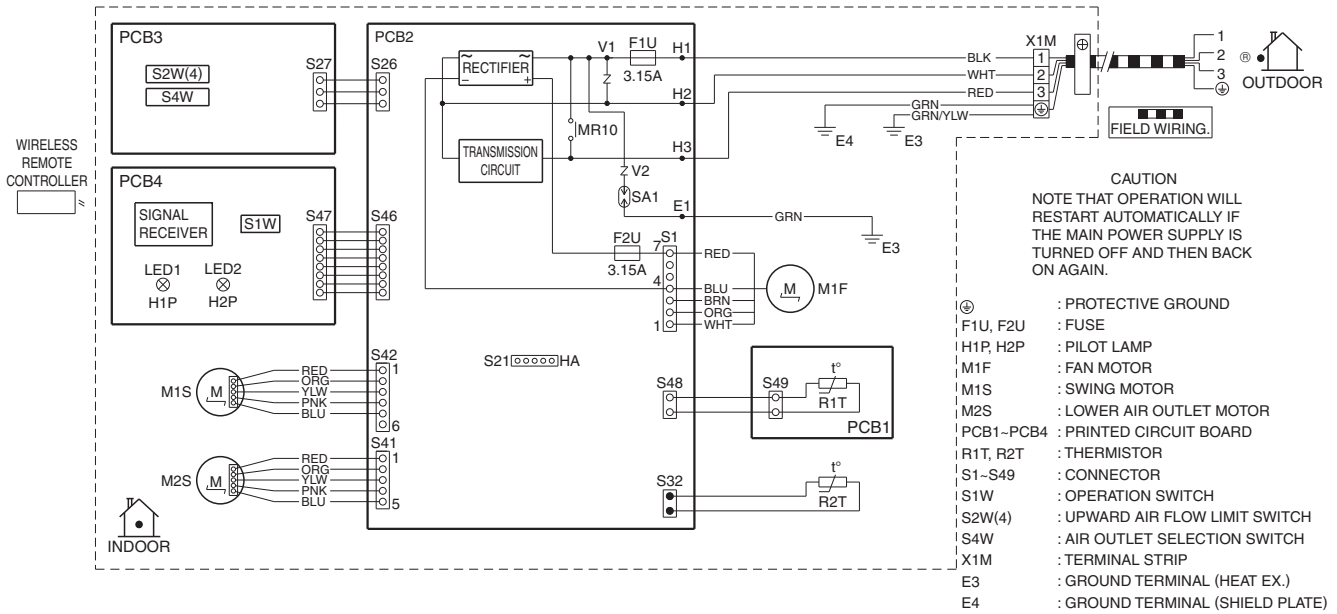

C: 3D090604A



Note(s)

- PCB1: Sensor PCB
 - PCB2: Control PCB
 - PCB3: Service PCB
 - PCB4: Display/signal receiver PCB
- Refer to page 28 for Printed Circuit Board Connector Wiring Diagram.

FDMQ12/18/24RVJU

WIRING DIAGRAM

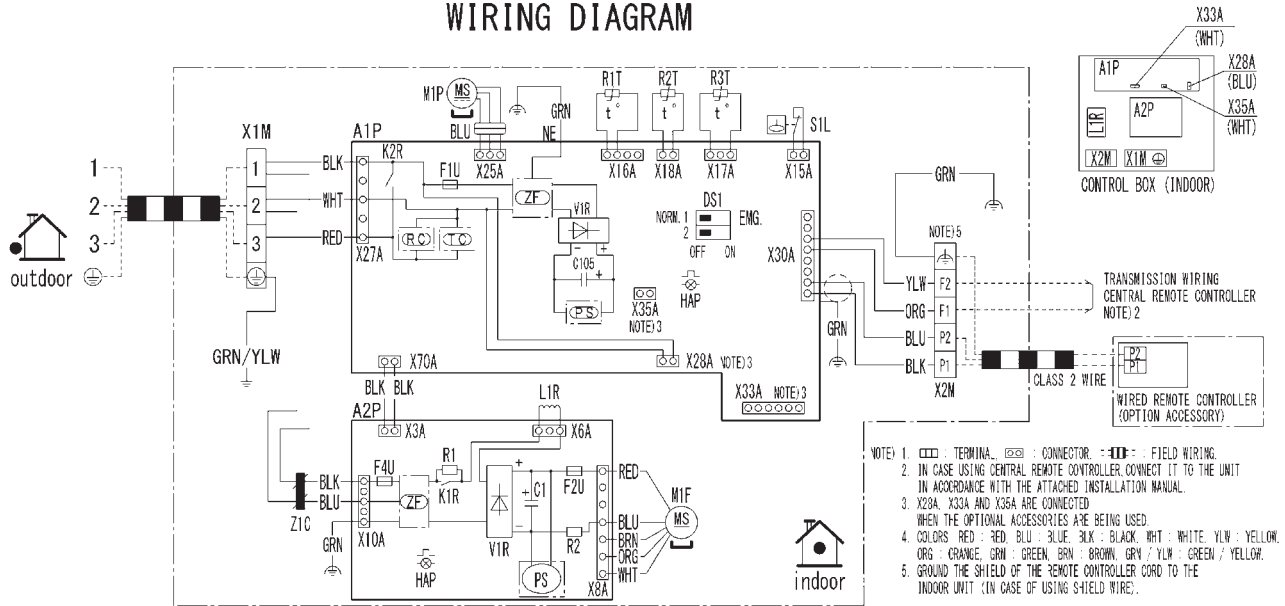

- NOTE 1: □ : TERMINAL, ⊞ : CONNECTOR, - : FIELD WIRING.
 2. IN CASE USING CENTRAL REMOTE CONTROLLER, CONNECT IT TO THE UNIT IN ACCORDANCE WITH THE ATTACHED INSTALLATION MANUAL.
 3. X28A, X33A AND X35A ARE CONNECTED WHEN THE OPTIONAL ACCESSORIES ARE BEING USED.
 4. COLORS: RED : RED, BLU : BLUE, BLK : BLACK, WHT : WHITE, YLW : YELLOW, ORG : ORANGE, GRN : GREEN, BRN : BROWN, GRV / YLW : GREEN / YELLOW.
 5. GROUND THE SHIELD OF THE REMOTE CONTROLLER CORD TO THE INDOOR UNIT (IN CASE OF USING SHIELD WIRE).

INDOOR UNIT	CONNECTOR	OPTIONAL ACCESSORY
A1P	X28A	CONNECTOR (POWER SUPPLY FOR WIRING)
A2P	X33A	CONNECTOR (FAN WIRING)
C1	X35A	CONNECTOR (DRAFTER)
C105		
DS1		
F1U		
F2U		
F4U		
HAP		
K1R		
K2R		
L1R		
M1F		
M1P		
R1		
R2		
R1T		
R2T		
R3T		
S1L		
V1R		
Z1C		
ZF		
PS		
RC		
TC		

3D112629A



Note(s)

A1P: Control PCB
 A2P: Indoor fan PCB
 Refer to page 30 for Printed Circuit Board Connector Wiring Diagram.

2.2 Outdoor Unit

RXL09QMJVJU

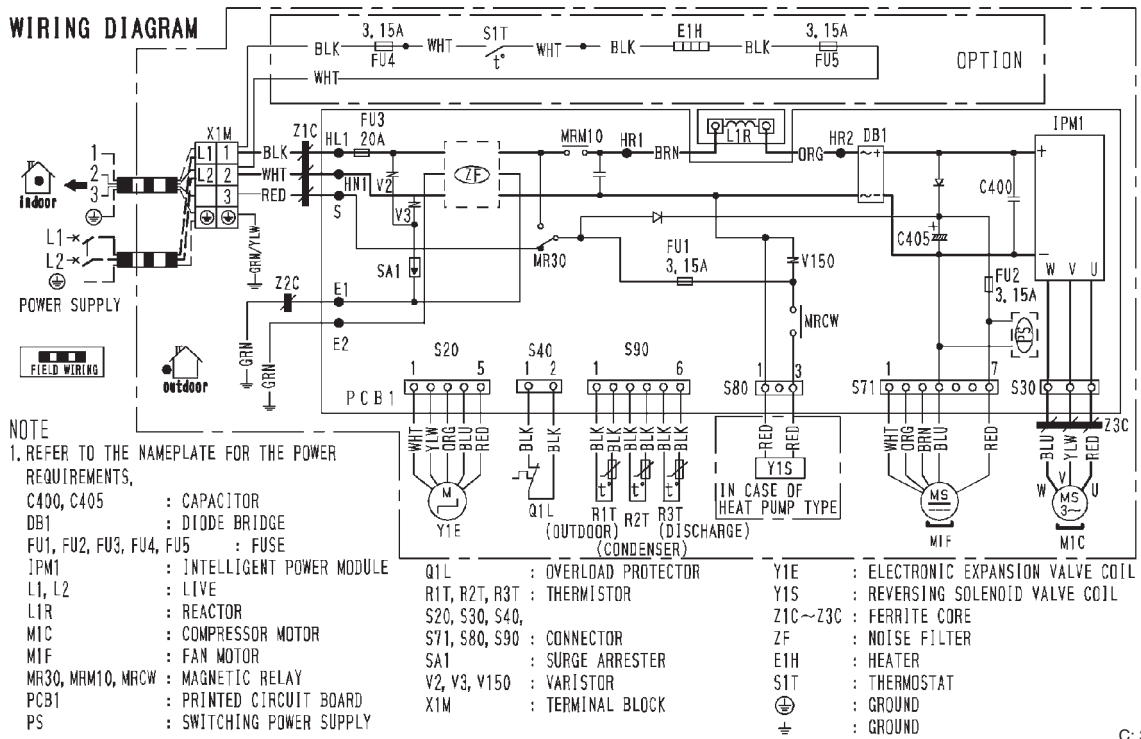

C: 3D099947



Note(s)

PCB1: Main PCB

Refer to page 34 for Printed Circuit Board Connector Wiring Diagram.

RXL12QMVJU

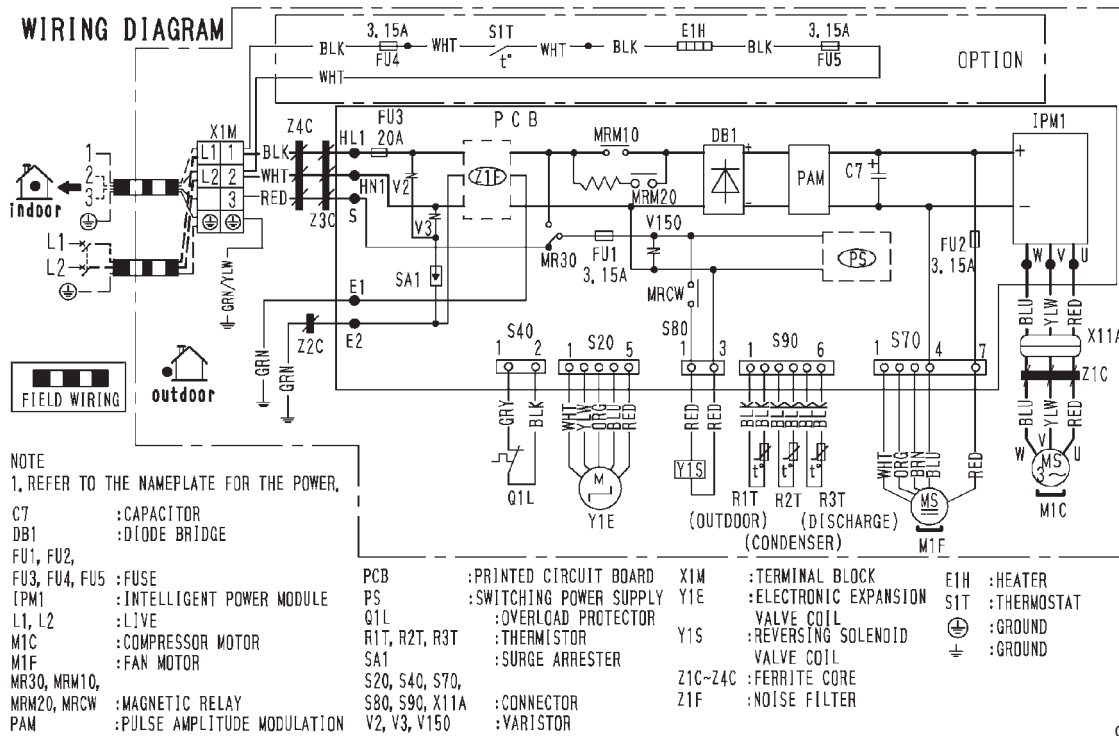
**Note(s)**

PCB: Main PCB

Refer to page 36 for Printed Circuit Board Connector Wiring Diagram.

RXL15QMVJU

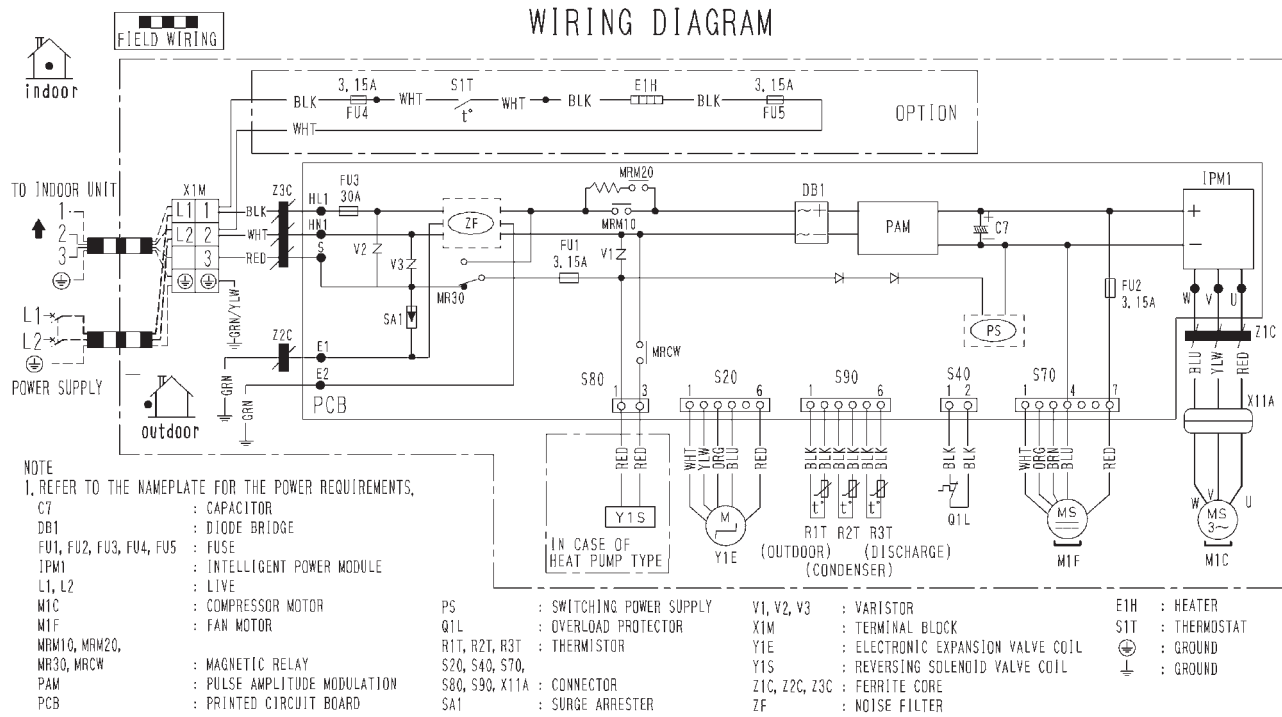

C: 3D099952



Note(s)

PCB: Main PCB

Refer to page 38 for Printed Circuit Board Connector Wiring Diagram.

RXL18/24UMVJU

WIRING DIAGRAM

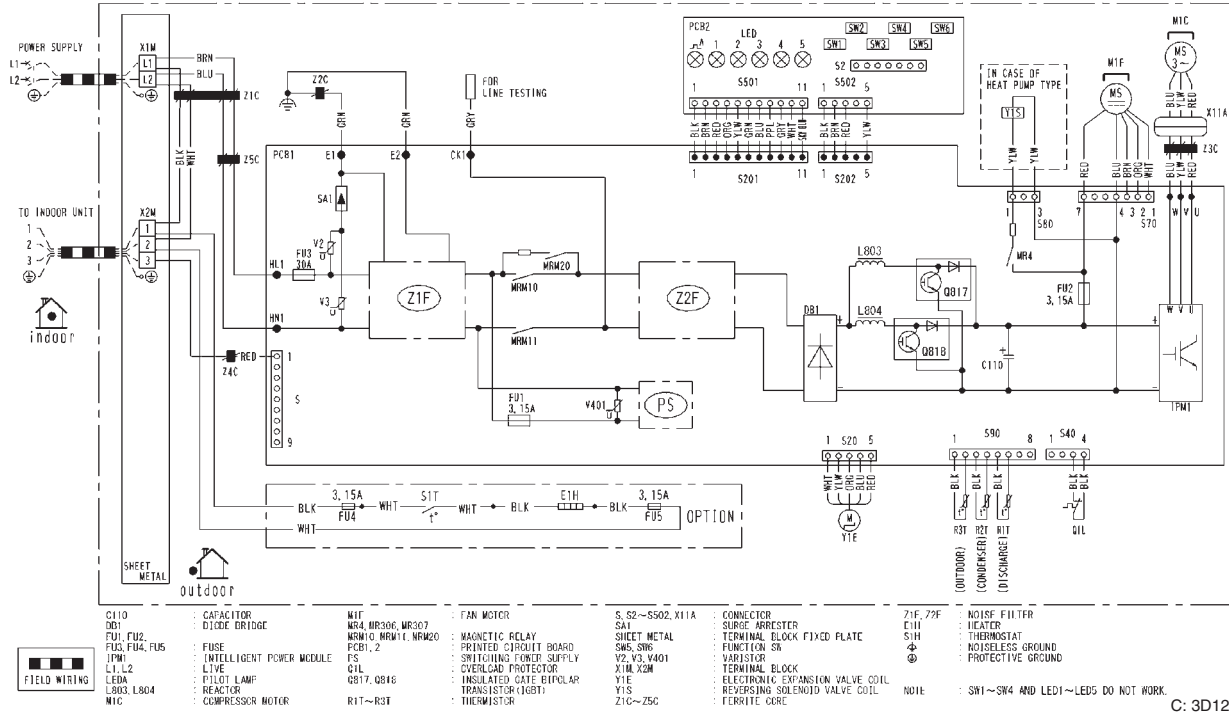

Note(s)

- PCB1: Main PCB
- PCB2: Service monitor PCB
- Refer to page 39 for Printed Circuit Board Connector Wiring Diagram.

3. Operation Limit

RXL09/12/15QMVJU

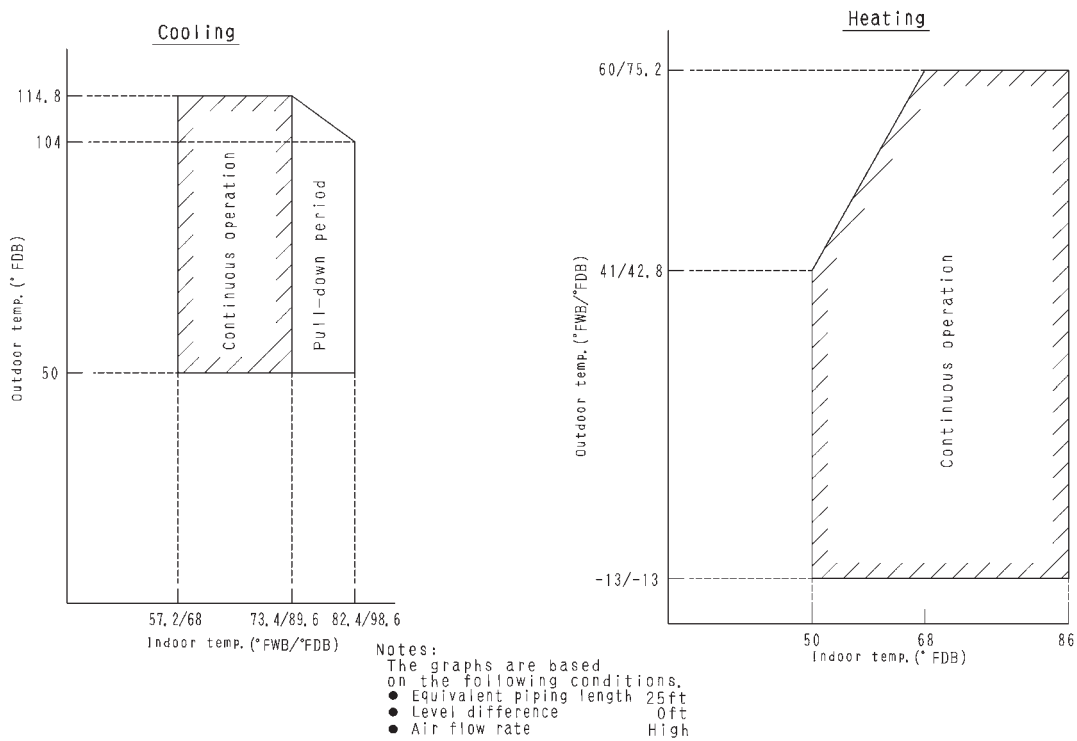

3D100732

RXL12QMVJU9, RXL18/24UMVJU

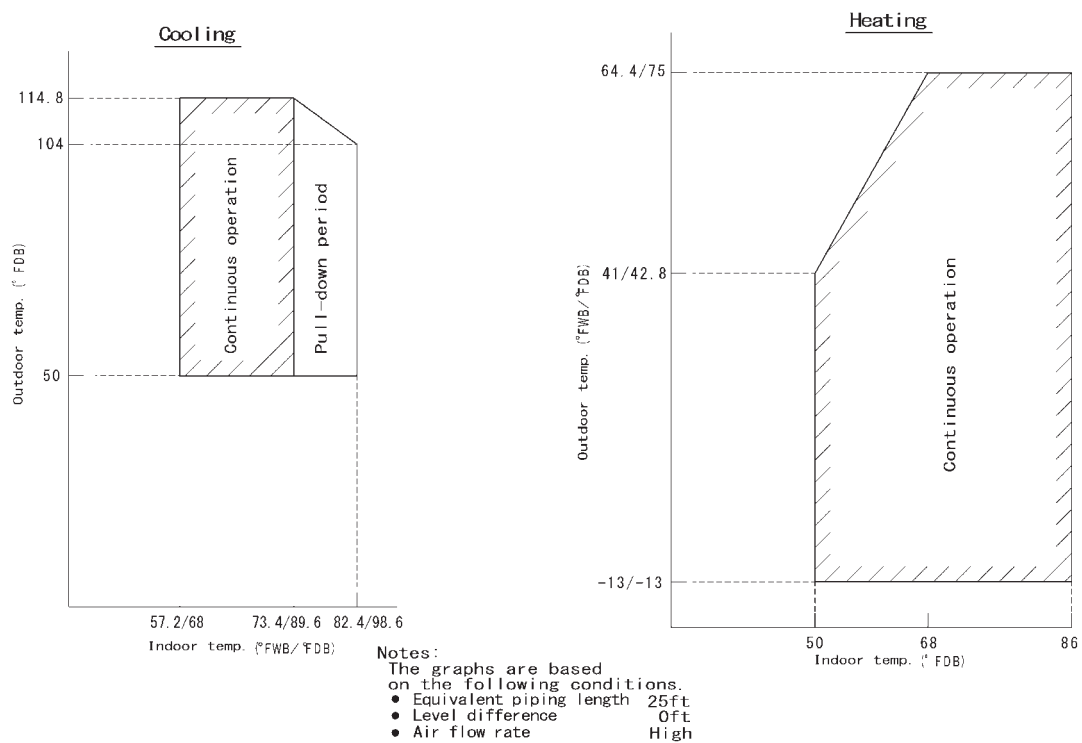

3D123451

Warning

- Daikin products are manufactured for export to numerous countries throughout the world. Prior to purchase, please confirm with your local authorized importer, distributor and/or retailer whether this product conforms to the applicable standards, and is suitable for use, in the region where the product will be used. This statement does not purport to exclude, restrict or modify the application of any local legislation.
- Ask a qualified installer or contractor to install this product. Do not try to install the product yourself. Improper installation can result in water or refrigerant leakage, electrical shock, fire or explosion.
- Use only those parts and accessories supplied or specified by Daikin. Ask a qualified installer or contractor to install those parts and accessories. Use of unauthorized parts and accessories or improper installation of parts and accessories can result in water or refrigerant leakage, electrical shock, fire or explosion.
- Read the user's manual carefully before using this product. The user's manual provides important safety instructions and warnings. Be sure to follow these instructions and warnings.

If you have any inquiries, please contact your local importer, distributor and/or retailer.

Cautions on product corrosion

1. Air conditioners should not be installed in areas where corrosive gases, such as acid gas or alkaline gas, are produced.
2. If the outdoor unit is to be installed close to the sea shore, direct exposure to the sea breeze should be avoided. If you need to install the outdoor unit close to the sea shore, contact your local distributor.

© All rights reserved