

# ECO-VENTILATION



SINGLE-ROOM  
ENERGY RECOVERY  
VENTILATORS



**TwinFresh Expert RW1-50-2**

SMART HOUSE

*Fresh air  
in your house!*



# SINGLE-ROOM ENERGY RECOVERY VENTILATORS

## TwinFresh Expert is a new series of single-room energy recovery ventilators

TwinFresh Expert is the most state-of-the-art and efficient solution for a comfortable indoor climate and required air exchange in renovated premises, brand new recently inhabited houses or reconstructed apartments.

## TwinFresh Expert RW1-50-2 features

- ▶ Unique Single Room Energy Recovery Ventilator.
- ▶ One TwinFresh Expert unit in ventilation mode can serve rooms up to 500 sq. ft.\*
- ▶ Controlled by Android or iOS smartphone through the cloud server from any part of the world.
- ▶ Wi-Fi communication between several ventilators for coordinated operation.
- ▶ Efficient supply and exhaust single-room ventilation up to 30 CFM.
- ▶ High-tech ceramic energy regenerator with max. heat recovery efficiency up to 93 %.
- ▶ Reversible DC motors with low energy demand from 4.45 W and safe voltage of 12 V.
- ▶ Integrated control system.
- ▶ Silent operation from 0.3 Sones.
- ▶ Easy mounting and maintenance.
- ▶ Air cleaning with total MERV 5 class filters (optionally MERV 14 filter).
- ▶ Rated for continuous operation.
- ▶ Frost- and condensate-free.



\*In accordance with ANSI/ASHRAE Standard 62.2-2016

## Ceramic energy regenerator

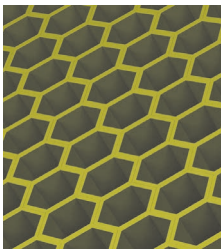

The high-tech ceramic regenerator with heat recovery efficiency up to 93 % is used for heating of supply air by means of the exhaust air heat recovery. Due to its honeycomb structure, the unique heat exchanger has larger air contact area and excellent heat conducting and accumulating properties. The ceramic regenerator has a special anti-bacterial treatment to prevent bacteria generation inside it. The antibacterial treatment is rated for 10 year operation.

One of the best heat recovery efficiency on the market due to innovative hexagonal structure of the heat exchanger cells

Decorative front panel



Open



Closed

The specially designed front panel can be closed manually to ensure 100% air tightness and protection against wind



Easy maintenance.  
The indoor unit is opened by pressing the latches on both sides



Integrated air shutters prevent air back drafting



**Reversible DC motor**

Air is supplied or exhausted by a reversible axial fan with DC motor. Due to DC technology the fan has outstanding low energy demand. The fan is powered by safe voltage 12 V. The motor has integrated overheating protection and ball bearings for long service life.

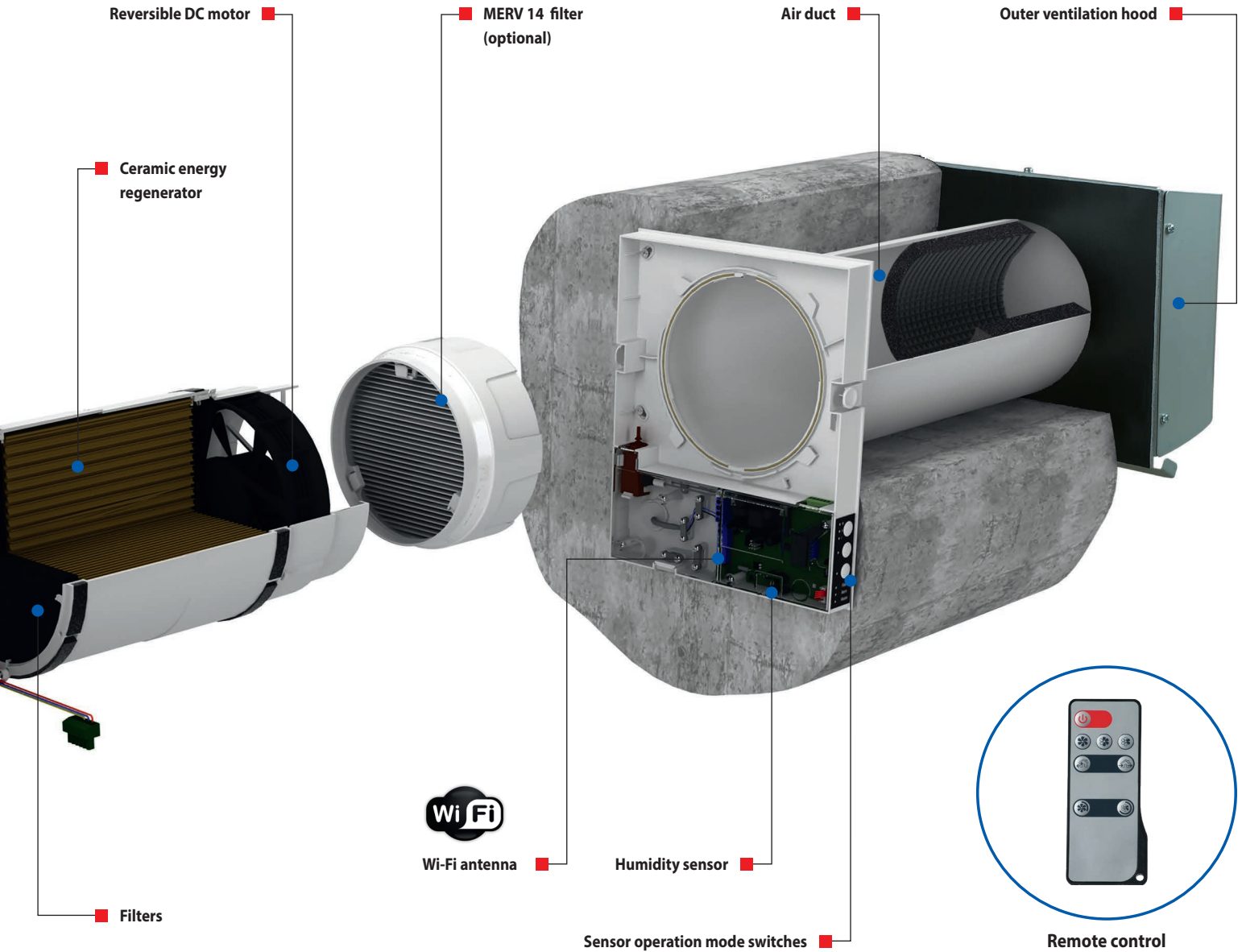

**Air filters**

The two integrated air filters with total filtration rate MERV 5 provide supply and exhaust air filtration. The filters prevent ingress of dust and insects into the supply air and contamination of the ventilator parts. The filters also have antibacterial treatment. The filter cleaning is done with a vacuum cleaner or water flushing. The antibacterial properties is not removed. MERV 14 filter with the filtration class PM2.5 99 % is available as a specially ordered accessory.\*

\* Reduces the air flow down to 24 CFM when installed.

## TwinFresh ventilator functioning

The ventilator is designed both for reversible mode with energy regeneration and supply or exhaust mode with no regeneration.

- ▶ **CYCLE I.** Warm stale air is exhausted from the premise, flows through the ceramic regenerator and transfers up to 93 % of the accumulated heat and moisture to it. As the ceramic regenerator gets warmed up, the ventilator switches to the supply mode.
- ▶ **CYCLE II.** Clean cold intake air flows through the regenerator and absorbs accumulated heat and humidity. In 70 seconds, after cooling of the ceramic regenerator, the ventilator is switched to the exhaust air mode and a new cycle starts.

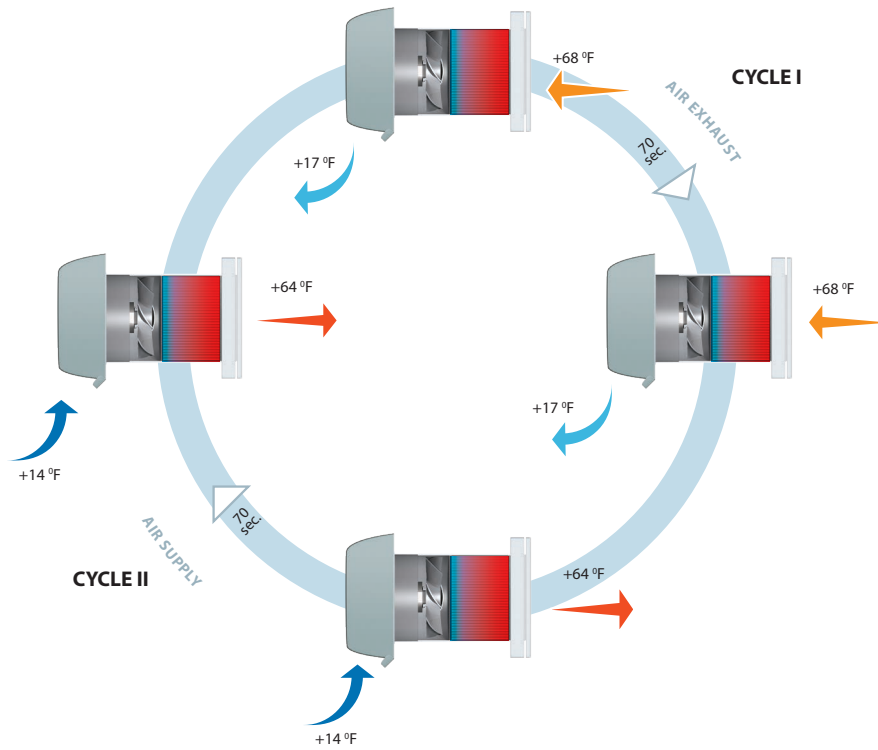

## Control

The ventilator is controlled means of:



control panel

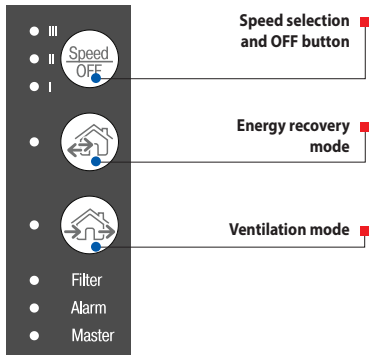

remote control

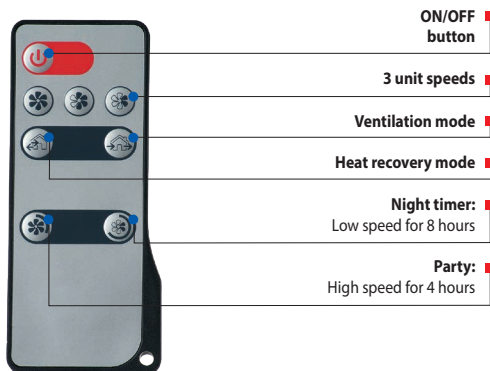

smartphone application



## Control

Connection of several ventilators via Wi-Fi for synchronous operation. Ventilation control via cloud service worldwide. Connection to Smart Home or BMS via Wi-Fi.



The app is available on the App Store and Google Play.

Download on the  
**App Store**



**Google Play**



The **TwinFresh Expert RW1-50-2** ventilator can be connected to a laptop for advanced settings:

- ▶ Primary or secondary modes.
- ▶ Supply or exhaust operation in ventilation mode.
- ▶ Connection of the unit to home Wi-Fi network.

## Mounting

The ventilator is designed for through-the-wall installation inside a prepared hole in an outer wall of the building.

The best ventilation solution is pairwise installation of reverse phase connected ventilators when some units ensure supply of fresh air to the room and the other units exhaust air from the premise. This way the most efficient balanced ventilation is arranged.

In case of brand new construction, the ventilators are mounted in two stages:

1. Pre-installation at the stage of the indoor finishing and outer decorative wall finishing. It includes installation of an air duct, an outer ventilation hood and cable installation.
2. Final mounting before commissioning of a house. It includes installation of a regenerator with a fan and filters and mounting and wiring of an indoor unit with a controller and shutters.

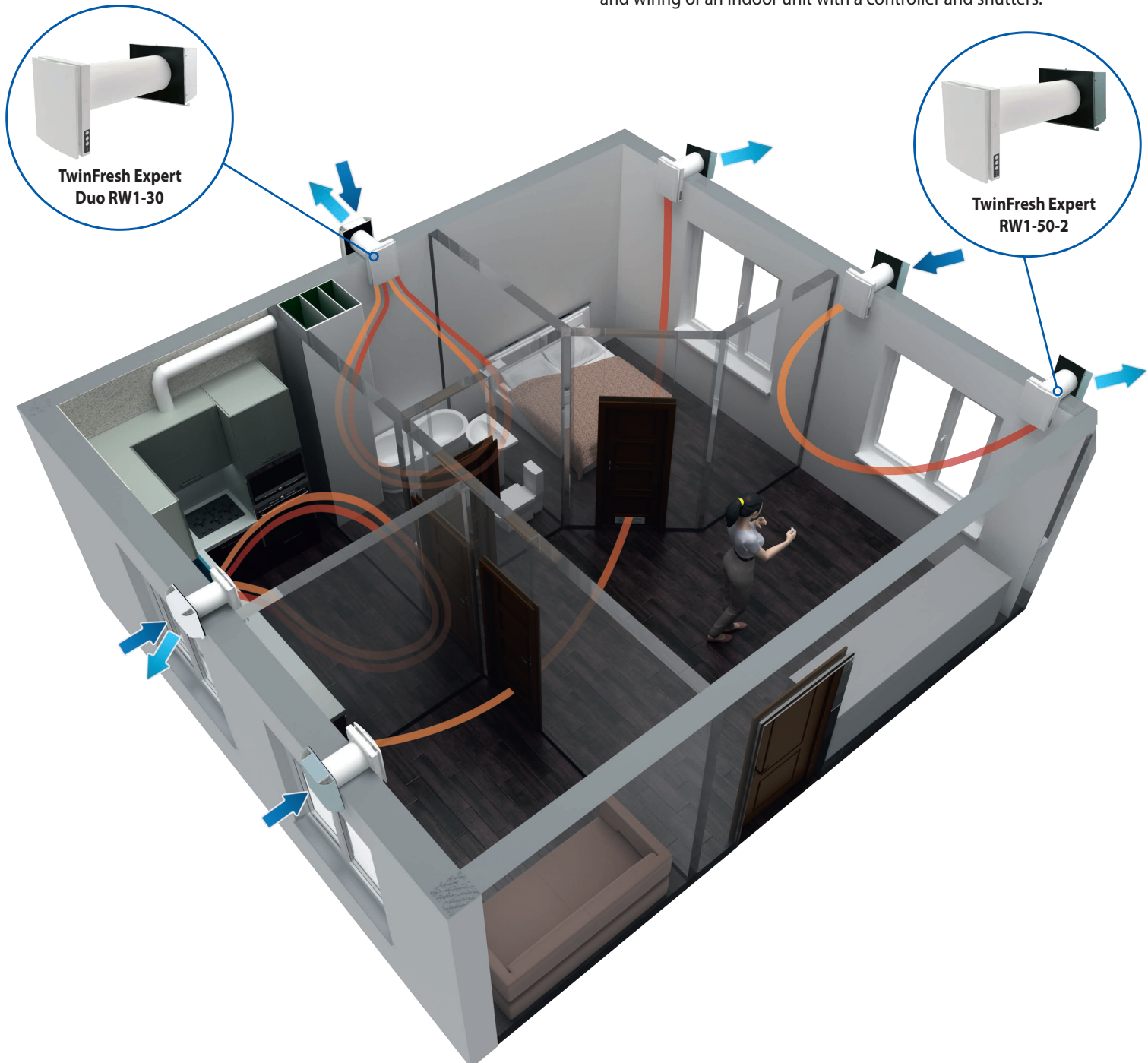

## Technical data

Model	TwinFresh Expert RW1-50-2		
Speed	1	2	3
Supply voltage, 50/60 Hz [V]	1~100-240		
Power [W]	4.45	5.08	7.06
Max. current consumption [A]	0.035	0.040	0.059
Air flow in ventilation mode [CFM]	9	18	30
Air flow in regeneration mode [CFM]	4	9	15
RPM	800	1300	1900
Sound pressure level @ 3 ft [Sones]	0.6	1.0	1.2
Sound pressure level @ 10 ft [Sones]	0.3	0.5	0.6
Outdoor sound pressure attenuation [Sones]	2.5		
Transported air temperature [°F]	from +5 up to +104		
Regenerating efficiency [%]	≤ 93		
Regenerator type	Ceramic		
Ingress Protection	IP24		

## Overall dimensions

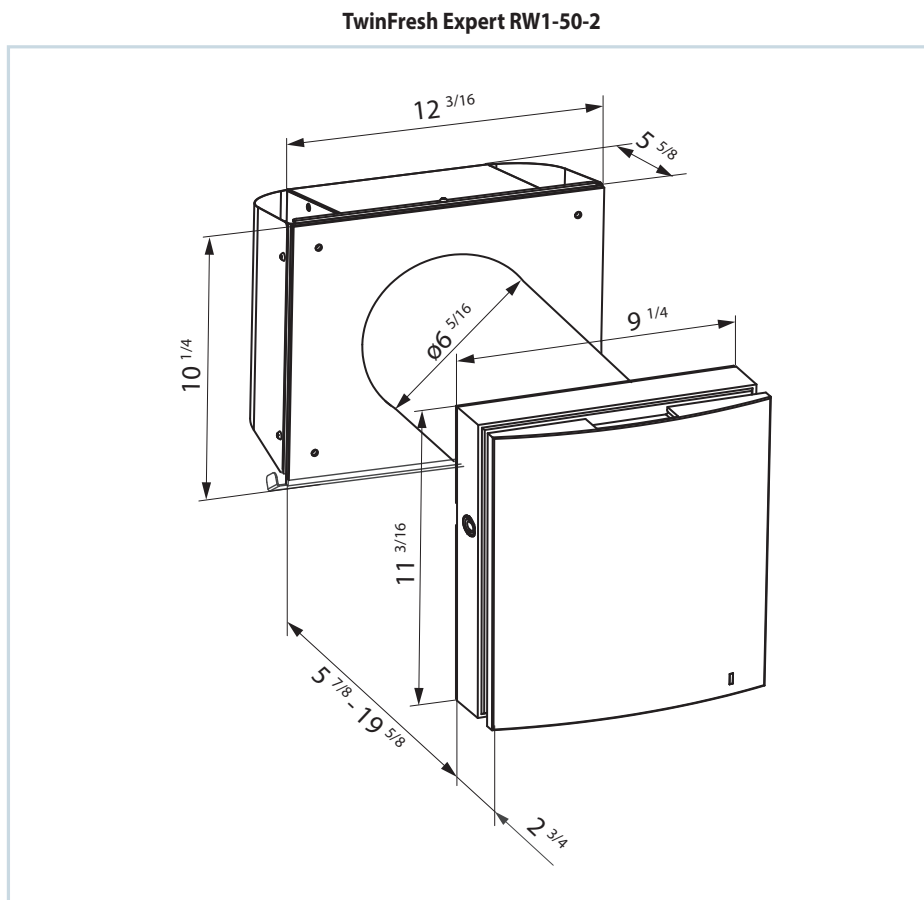



**Accessories**

Accessory image	Accessory name	Description	Accessory image	Accessory name	Description
	EH-2 grey 160	Grey steel outer hood for thin walls		T TwinFresh Expert R-50	Cardboard template for indoor unit installation
	EH-2 chrome 160	Brushed stainless steel outer hood for thin walls		SF TwinFresh Expert R-50 F8	MERV 14 Filter (1 piece)
	KV TwinFresh Expert RW	Wi-Fi controlled control panel		SF TwinFresh Expert R-50 G3	MERV 5 filter set (2 pcs.)
	RC1 TwinFresh	Remote control		Completion kit TwinFresh Expert RW1-50	- indoor unit - cartridge with regenerator, fan and two filters - sound-insulating material - remote control
	CO2-1	CO <sub>2</sub> sensor		Duct 160-500	Air duct 500 mm
	CO2-2	CO <sub>2</sub> sensor with a LED CO <sub>2</sub> concentration indicator and a touch button to switch the CO <sub>2</sub> sensor operation mode			

Tel: 888-640-0925  
513-348-3853  
Fax: 513-268-4597

Sales@ventsus.com  
VentsUS.com  
11013 Kenwood Road,  
Cincinnati, Ohio 45242

**VENTS reserves the rights to modify any of its products' features, designs, components and specifications at any time and without notice to maintain the development and quality of manufactured goods.**

01-2020

