



Replacement Parts Catalog

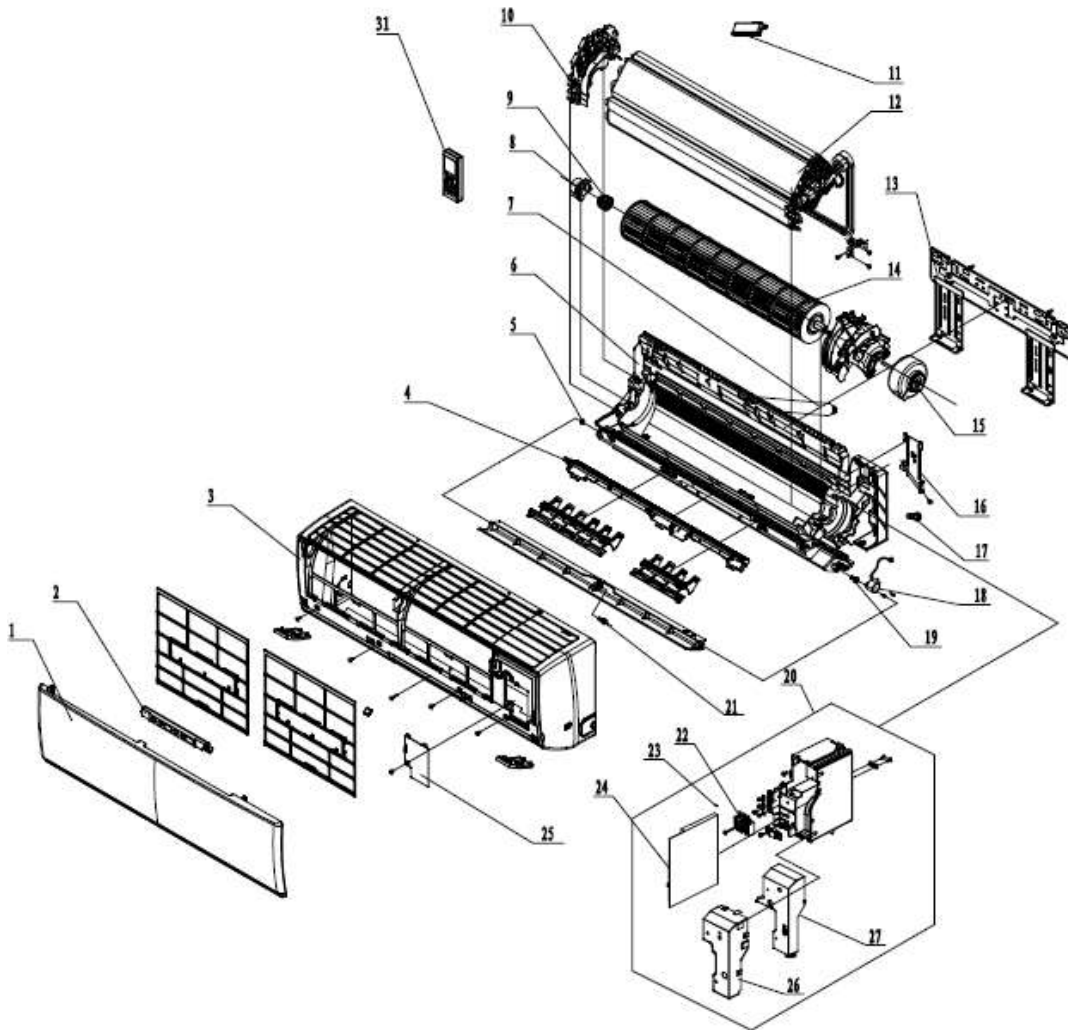

Table of Contents

Model Number	Description	Page
Nomenclature	Part Number Nomenclature Chart	3-4
VIR09HP115V1AH	Vireo Heat Pump 9,000 BTUH 115v Indoor Unit	5-6
VIR09HP115V1AO	Vireo Heat Pump 9,000 BTUH 115v Outdoor Unit	7-8
VIR09HP230V1AH	Vireo Heat Pump 9,000 BTUH 208/230v Indoor Unit	9-19
VIR09HP230V1AO	Vireo Heat Pump 9,000 BTUH 208/230v Outdoor Unit	11-12
VIR12HP115V1AH	Vireo Heat Pump 12,000 BTUH 208/230v Indoor Unit	13-14
VIR12HP115V1AO	Vireo Heat Pump 12,000 BTUH 115v Outdoor Unit	15-16
VIR12HP230V1AH	Vireo Heat Pump 12,000 BTUH 208/230v Indoor Unit	17-18
VIR12HP230V1AO	Vireo Heat Pump 12,000 BTUH 208/230v Outdoor Unit	19-20
VIR18HP230V1AH	Vireo Heat Pump 18,000 BTUH 208/230v Indoor Unit	21-22
VIR18HP230V1AO	Vireo Heat Pump 18,000 BTUH 208/230v Outdoor Unit	23-24
VIR24HP230V1AH	Vireo Heat Pump 24,000 BTUH 208/230v Indoor Unit	25-26
VIR24HP230V1AO	Vireo Heat Pump 24,000 BTUH 208/230v Outdoor Unit	27-28
VIR30HP230V1AH	Vireo Heat Pump 30,000 BTUH 208/230v Indoor Unit	29-30
VIR30HP230V1AO	Vireo Heat Pump 30,000 BTUH 208/230v Outdoor Unit	31-32
VIR36HP230V1AH	Vireo Heat Pump 36,000 BTUH 208/230v Indoor Unit	33-34
VIR36HP230V1AO	Vireo Heat Pump 36,000 BTUH 208/230v Outdoor Unit	35-36
VIR09HP115V1BH	Vireo+ Heat Pump 9,000 BTUH 115v Indoor Unit	37-38
VIR09HP115V1BO	Vireo+ Heat Pump 9,000 BTUH 115v Outdoor Unit	39-40
VIR09HP230V1BH	Vireo+ Heat Pump 9,000 BTUH 208/230v Indoor Unit	41-42
VIR09HP230V1BO	Vireo+ Heat Pump 9,000 BTUH 208/230v Outdoor Unit	43-44
VIR12HP115V1BH	Vireo+ Heat Pump 12,000 BTUH 208/230v Indoor Unit	45-46
VIR12HP115V1BO	Vireo+ Heat Pump 12,000 BTUH 115v Outdoor Unit	47-48
VIR12HP230V1BH	Vireo+ Heat Pump 12,000 BTUH 208/230v Indoor Unit	49-50
VIR12HP230V1BO	Vireo+ Heat Pump 12,000 BTUH 208/230v Outdoor Unit	51-52
VIR18HP230V1BH	Vireo+ Heat Pump 18,000 BTUH 208/230v Indoor Unit	53-54
VIR18HP230V1BO	Vireo+ Heat Pump 18,000 BTUH 208/230v Outdoor Unit	55-56
VIR24HP230V1BH	Vireo+ Heat Pump 24,000 BTUH 208/230v Indoor Unit	57-58
VIR24HP230V1BO	Vireo+ Heat Pump 24,000 BTUH 208/230v Outdoor Unit	59-60
VIR30HP230V1BH	Vireo+ Heat Pump 30,000 BTUH 208/230v Indoor Unit	61-62
VIR30HP230V1BO	Vireo+ Heat Pump 30,000 BTUH 208/230v Outdoor Unit	63-64
VIR36HP230V1BH	Vireo+ Heat Pump 36,000 BTUH 208/230v Indoor Unit	65-66
VIR36HP230V1BO	Vireo+ Heat Pump 36,000 BTUH 208/230v Outdoor Unit	67-68

Product Catalog Number-Nomenclature

(2015 and later)

Example: VIR24HP230V1AH

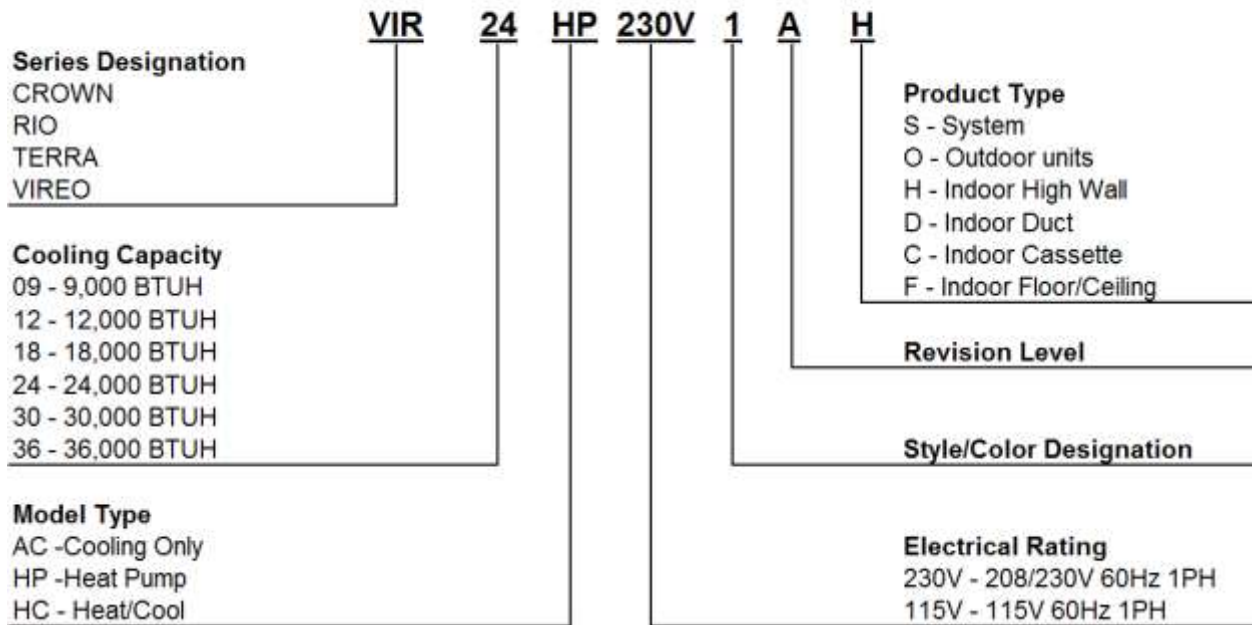

Typical Product Installation

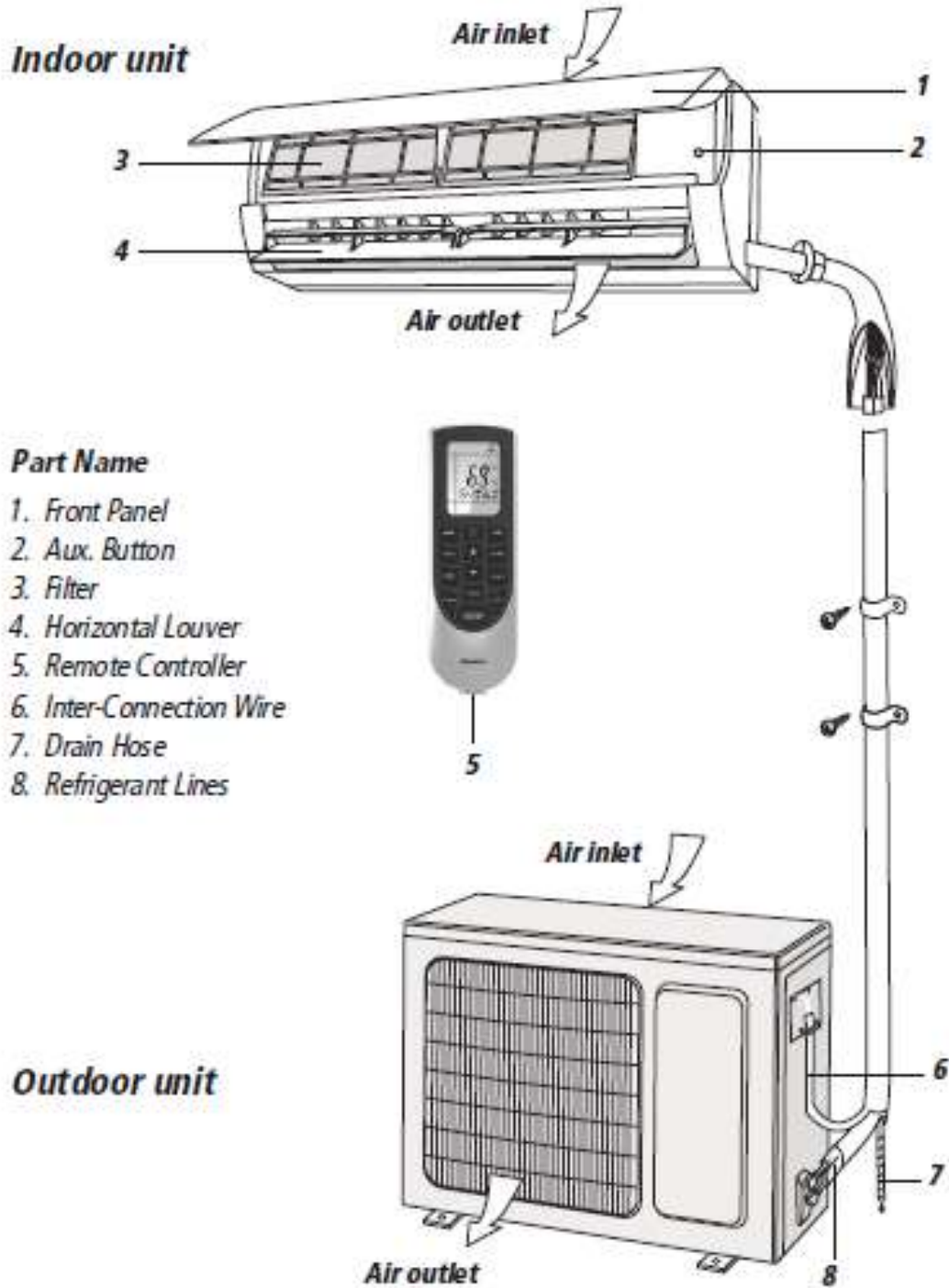

VIR09HP115V1AH

9,000 BTUH 115v Indoor Unit

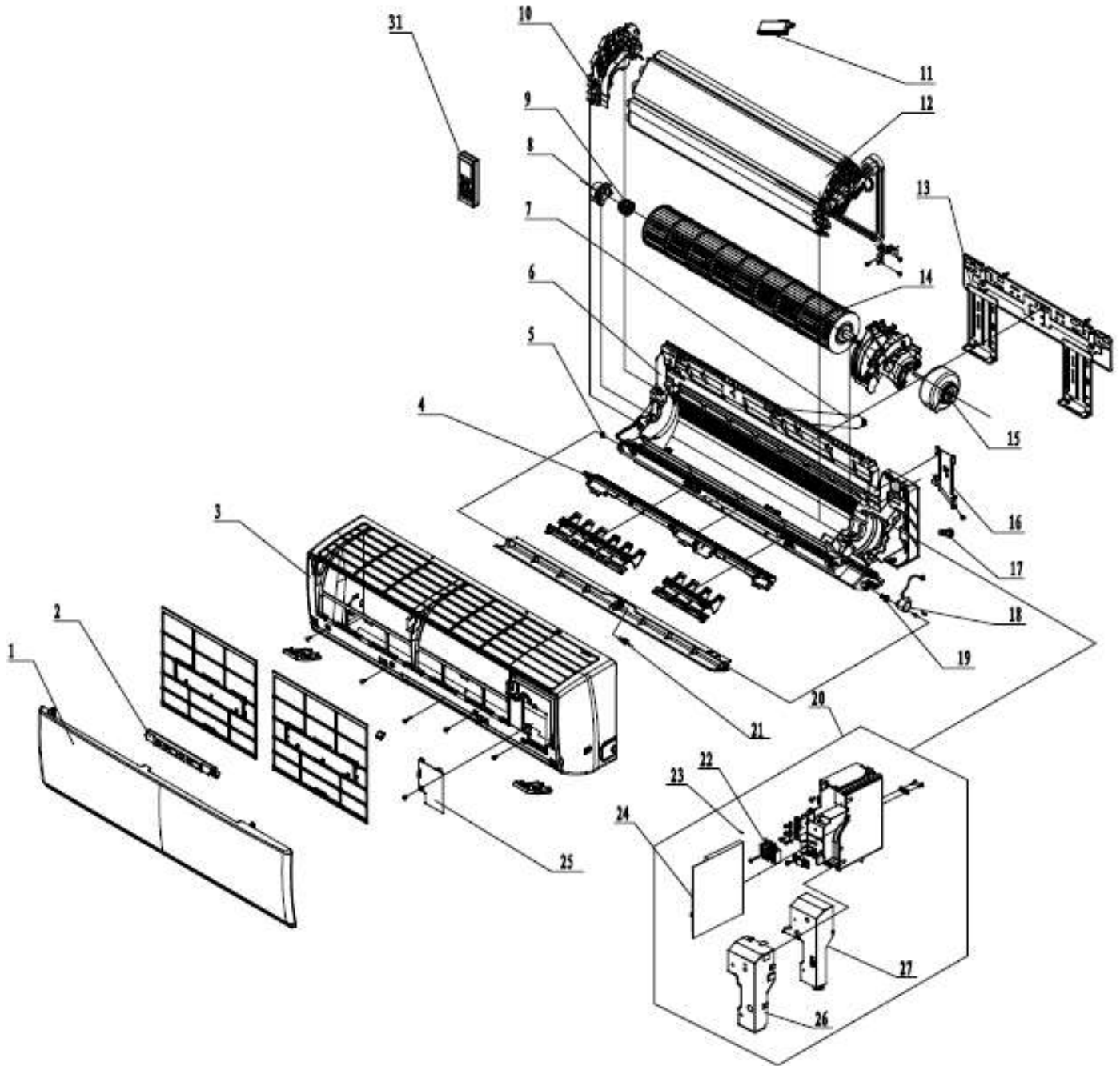

VIR09HP115V1AH
9,000 BTUH 115v Indoor Unit
Product Code: GWH09QC-A3DNB2D/I

NO.	Part Code	Part Description	Qty
1	20000300018S	Front Panel B2	1
Not Shown	11122468	Air Filter	2
2	30565260	Display Board	1
3	00000200045	Front Case Assy	1
4	26112436	Helicoid Tongue	1
5	10512037	Left Axial Bushing	1
6	00000100093	Rear Case Assy	1
7	05230014	Drainage Hose	1
8	26152022	Bearing Ring	1
9	7651205102	Bearing Ring O-Gasket Sub-Assy	1
10	24212174	Evaporator Support	1
12	01002000030	Evaporator Coil Assy	1
13	01252484	Wall Mounting Bracket	1
14	10352056	Cross Flow Fan	1
15	15012153	Fan Motor	1
16	2611216401	Condensate Pipe Clamp	1
17	76712012	Condensate Drain Plug	1
18	1521210701	Stepper Motor	1
19	73012005	Crank	1
20	10000201783	Electric Control Box Assy	1
21	10542036	Axial Bushing	1
22	42011233	Terminal Board	1
23	4202021909	Configuration Jumper	1
24	30138000318	Main Control Board	1
25	0140206501	Electric Box Cover Sub-Assy	1
26	01592150	Electric Box Shield Cover	1
27	2011220701	Electric Box Cover	1
Not Shown	3900031302	Ambient Temperature Sensor	1
Not Shown	3900031302	Indoor Coil Temperature Sensor	1
31	30510475	Remote Controller (YAN1F1F)	1
Not Shown	26150009	Remote Controller Holder/Cradle	1

VIR09HP115V1AO

9,000 BTUH 115v Outdoor Unit

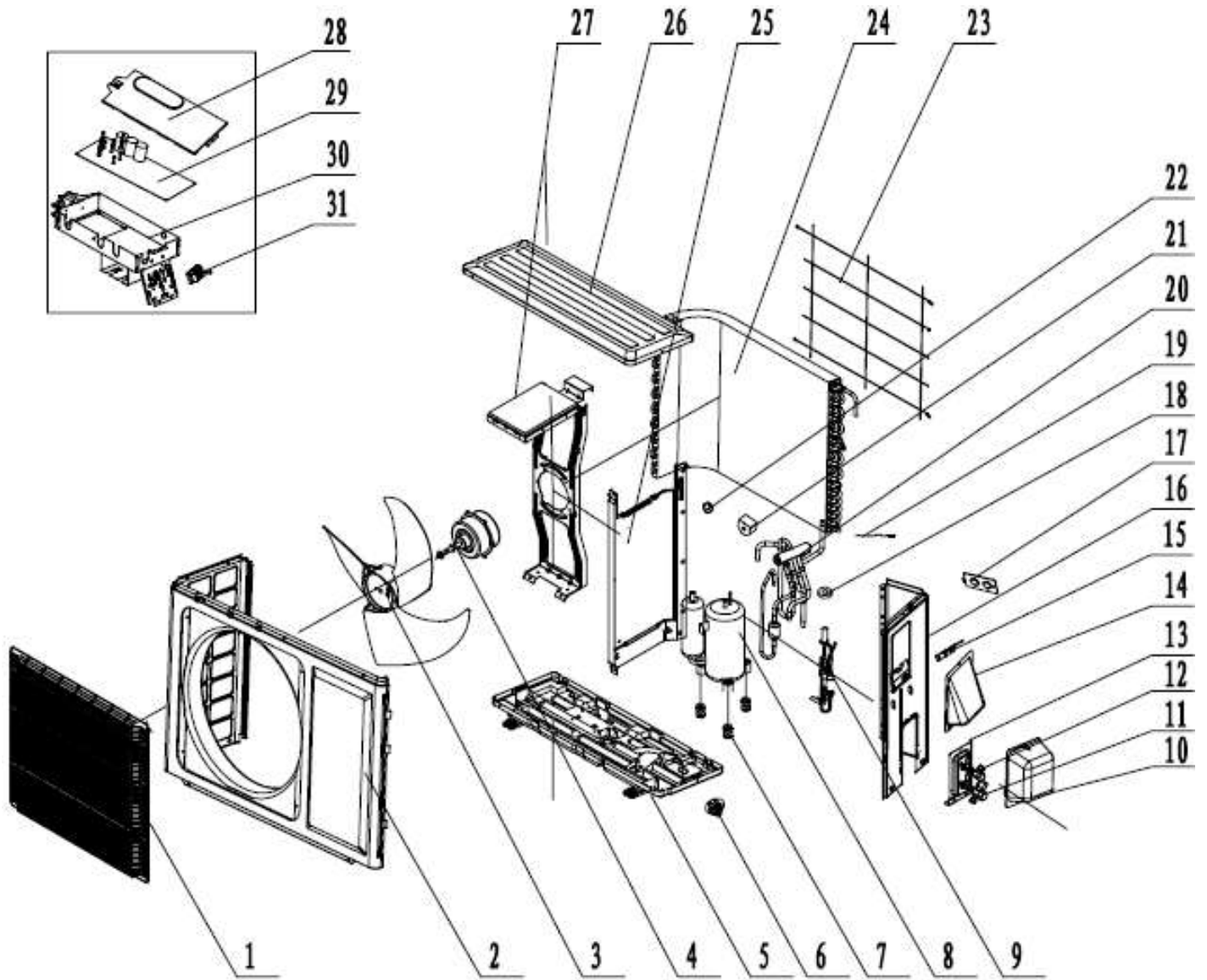

VIR09HP115V1AO
9,000 BTUH 115v Outdoor Unit
Product Code: GWH09QC-A3DNA1D/O

NO.	Part Code	Part Description	Qty
1	01473012	Front Grille	1
2	0153304901	Front Panel Assy	1
3	10333004	Axial Flow Fan	1
4	1501308505	Fan Motor	1
5	01203881P	Chassis Sub-Assy	1
6	06123401	Drainage Connector	1
Not Shown	76510010	Basepan Heater	1
7	76710302	Compressor Grommet	3
Not Shown	76510009	Compressor Crankcase Heater	1
8	00103862	Compressor and Fittings	1
Not Shown	03700200294	Capillary Sub-Assy	1
Not Shown	07135228	Electronic Expansion Valve	!
9	03002600039	Electronic Expansion Valve Assy	1
Not Shown	4300876704	Electronic Expansion Valve Solenoid Coil	1
10	2012300101	Valve Cover	1
11	07130239	1/4-in Liquid Line Valve	1
12	07100005	3/8-in Gas/Suction Valve	1
13	01713041	Valve Support	1
14	02123014P	Cable Cross Plate 2	1
15	02123013P	Cable Cross Plate 1	1
16	013030713	Right Side Plate Assy	1
17	01413069	Pass Wire Cover	1
18	4300876704	Electric Expansion Valve Fitting	1
19	39000310	Temperature Sensor Assy **	1
Not Shown	430004022	4-Way Valve	1
20	03015200082	4-Way Valve Assy	1
21	4300040021	4-Way Valve Solenoid Coil	1
22	00180030	Compressor Overload Protector(External)	1
Not Shown	00183032	Compressor Overload Protector(External)	1
Not Shown	00183031	Compressor Overload Protector(External)	1
23	01473057	Rear Grille	1
24	01100200189	Condenser Coil Assy	1
25	01233034	Clapboard Sub-Assy	1
26	01253443	Top Cover Plate	1
28	0260309601	Electric Box Cover Sub-Assy	1
29	30138000523	Main Control Board	1
30	10000100182	Electric Control Box Assy	1
31	42010255	Terminal Board	1

** Temperature Sensor Assembly contains Discharge, Condenser Coil and Ambient sensors.

VIR09HP230V1AH

9,000 BTUH 208/230v Indoor Unit

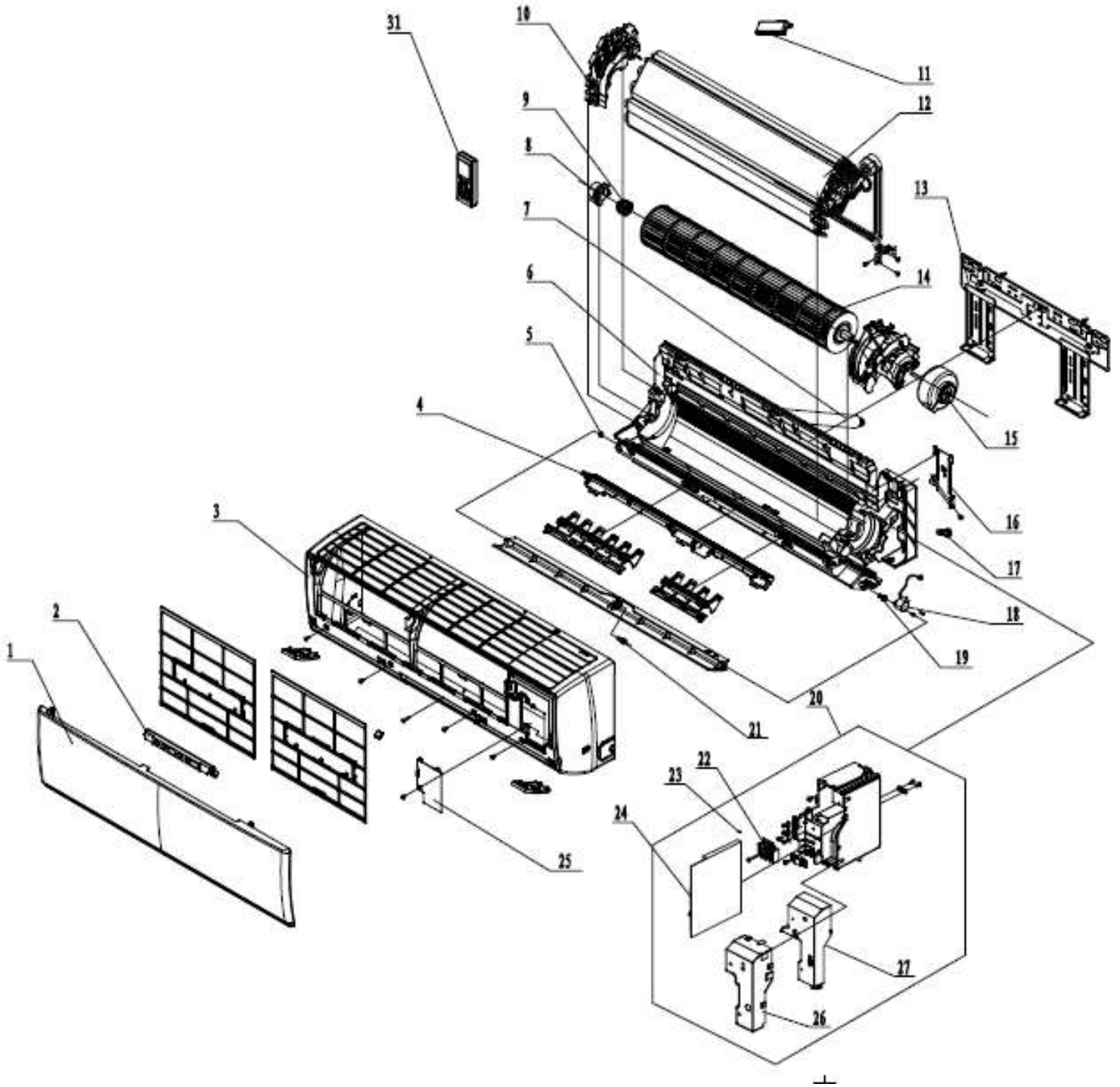

VIR09HP230V1AH
9,000 BTUH 208/230v Indoor Unit
Product Code: GWH09QC-D3DNB2D/I

NO.	Part Code	Part Description	Qty
1	20000300018S	Front Panel B2	1
Not Shown	11122468	Air Filter	2
2	30565260	Display Board	1
3	00000200045	Front Case Assy	1
4	26112436	Helicoid Tongue	1
5	10512037	Left Axial Bushing	1
6	00000100093	Rear Case Assy	1
7	05230014	Drainage Hose	1
8	26152022	Bearing Ring	1
9	7651205102	Bearing Ring O-Gasket Sub-Assy	1
10	24212174	Evaporator Support	1
12	01002000030	Evaporator Coil Assy	1
13	01252484	Wall Mounting Bracket	1
14	10352056	Cross Flow Fan	1
15	1501246601	Fan Motor	1
16	2611216401	Condensate Pipe Clamp	1
17	76712012	Condensate Drain Plug	1
18	1521210701	Stepper Motor	1
19	73012005	Crank	1
20	10000201783	Electric Control Box Assy	1
21	10542036	Axial Bushing	1
22	42011233	Terminal Board	1
23	4202021909	Configuration Jumper	1
24	30138000318	Main Control Board	1
25	0140206501	Electric Box Cover Sub-Assy	1
26	01592150	Electric Box Shield Cover	1
27	2011220701	Electric Box Cover	1
Not Shown	3900031302	Ambient Temperature Sensor	1
Not Shown	3900031302	Indoor Coil Temperature Sensor	1
31	30510475	Remote Controller (YAN1F1F)	1
Not Shown	26150009	Remote Controller Holder/Cradle	1

VIR09HP230V1AO

9,000 BTUH 208/230v Outdoor Unit

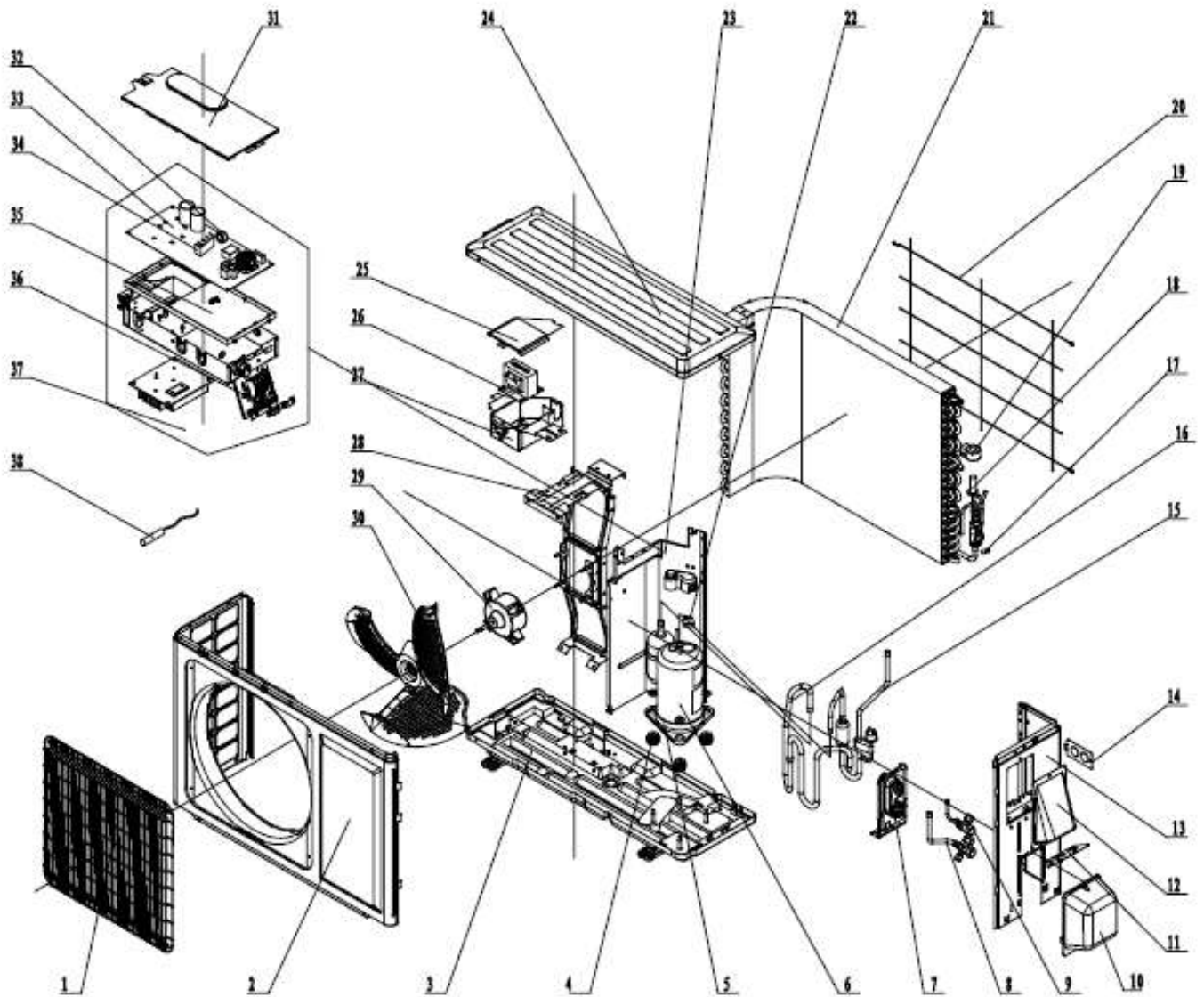

VIR09HP230V1AO
9,000 BTUH 208/230v Outdoor Unit
Product Code: GWH09QC-D3DNA1D/O

NO.	Part Code	Part Description	Qty
1	01473012	Front Grille	1
2	0153304901	Front Panel Assy	1
3	01700000053P	Chassis Sub-Assy	1
Not Shown	76513004	Basepan Heater	1
4	76713027	Compressor Grommet	3
5	76513004	Compressor Crankcase Heater	1
6	00103892	Compressor and Fittings	1
Not Shown	03133693	Capillary Sub-Assy	1
7	01713041	Valve Support	1
8	07100005	3/8-in Gas/Suction Valve	1
9	07100003	1/4-in Liquid Line Valve	1
10	2012300101	Valve Cover	1
11	02123013P	Cable Cross Plate 1	1
12	02123014P	Cable Cross Plate 2	1
13	0130306903	Right Side Plate	1
14	01413069	Pass Wire Cover	1
15	03733709	Discharge Tube Sub-Assy	1
16	03833444	Inhalation/Suction Tube Sub-Assy	1
17	05212423	Temp Sensor Sleeve	1
Not Shown	07130369	Electronic Expansion Valve	1
18	07133769	Electronic Expansion Valve Assy	1
19	4300876708	Electronic Expansion Valve Solenoid Coil	1
20	01473057	Rear Grille	1
Not Shown	430004032	4-Way Valve	1
Not Shown	4300040047	4-Way Valve Solenoid Coil	1
21	01163565	Condenser Coil Assy	1
22	00183111	Compressor Overload Protector(External)	1
Not Shown	00183114	Compressor Overload Protector(External)	1
23	01233034	Clapboard Sub-Assy	1
24	01253443	Top Cover Plate	1
25	01413029	Reactor Box Cover	1
26	43130185	Reactor	1
27	01413092	Reactor Box	1
29	1501308505	Fan Motor	1
30	10333004	Axial Flow Fan	1
31	0260309601	Electric Box Cover Sub-Assy	1
32	49010104	Magnetic Ring	1
33	30138000521	Main Control Board	1
34	49013026	Heat Sink/Radiator	1
35	20113005	Electric Control Box 1	1
36	71010003	Wire Clamp	1
37	10000100188	Electric Control Box Assy	1
38	39000310	Temperature Sensor Assy **	1

** Temperature Sensor Assembly contains Discharge, Condenser Coil and Ambient sensors.

VIR12HP115V1AH

12,000 BTUH 115v Indoor Unit

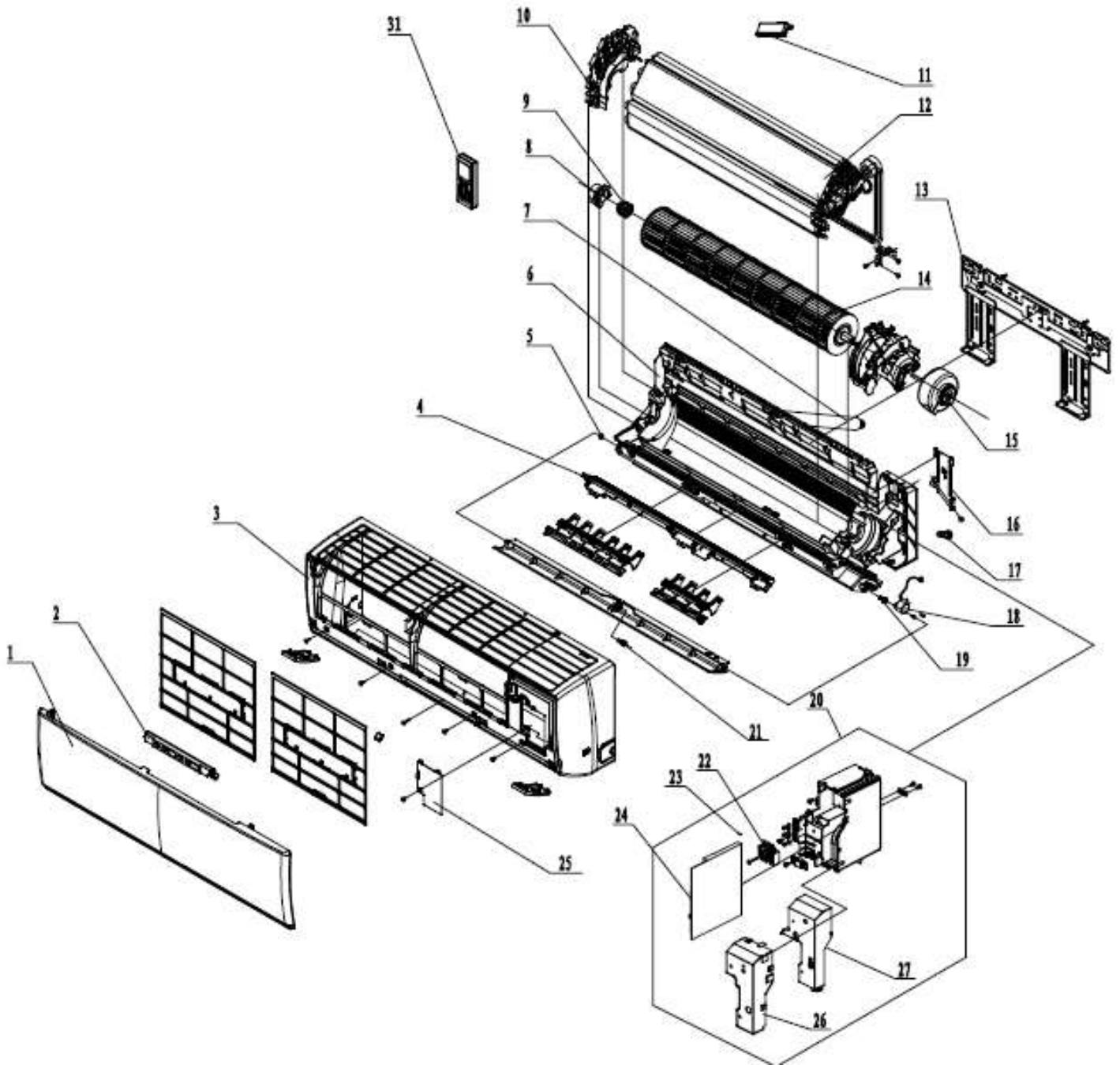

VIR12HP115V1AH
12,000 BTUH 115v Indoor Unit
Product Code: GWH12QC-A3DNB2D/I

NO.	Part Code	Part Description	Qty
1	20000300018S	Front Panel B2	1
Not Shown	11122468	Air Filter	2
2	30565260	Display Board	1
3	00000200045	Front Case Assy	1
4	26112436	Helicoid Tongue	1
5	10512037	Left Axial Bushing	1
6	00000100093	Rear Case Assy	1
7	05230014	Drainage Hose	1
8	26152022	Bearing Ring	1
9	7651205102	Bearing Ring O-Gasket Sub-Assy	1
10	24212174	Evaporator Support	1
12	0100200003001	Evaporator Coil Assy	1
13	01252484	Wall Mounting Bracket	1
14	10352056	Cross Flow Fan	1
15	15012153	Fan Motor	1
16	2611216401	Condensate Pipe Clamp	1
17	76712012	Condensate Drain Plug	1
18	1521210701	Stepper Motor	1
19	73012005	Crank	1
20	10000201787	Electric Control Box Assy	1
21	10542036	Axial Bushing	1
22	42011233	Terminal Board	1
23	4202021920	Configuration Jumper	1
24	30138000318	Main Control Board	1
25	0140206501	Electric Box Cover Sub-Assy	1
26	01592150	Electric Box Shield Cover	1
27	2011220701	Electric Box Cover	1
Not Shown	3900031302	Ambient Temperature Sensor	1
Not Shown	3900031302	Indoor Coil Temperature Sensor	1
31	30510475	Remote Controller (YAN1F1F)	1
Not Shown	26150009	Remote Controller Holder/Cradle	1

VIR12HP115V1AO

12,000 BTUH 115v Outdoor Unit

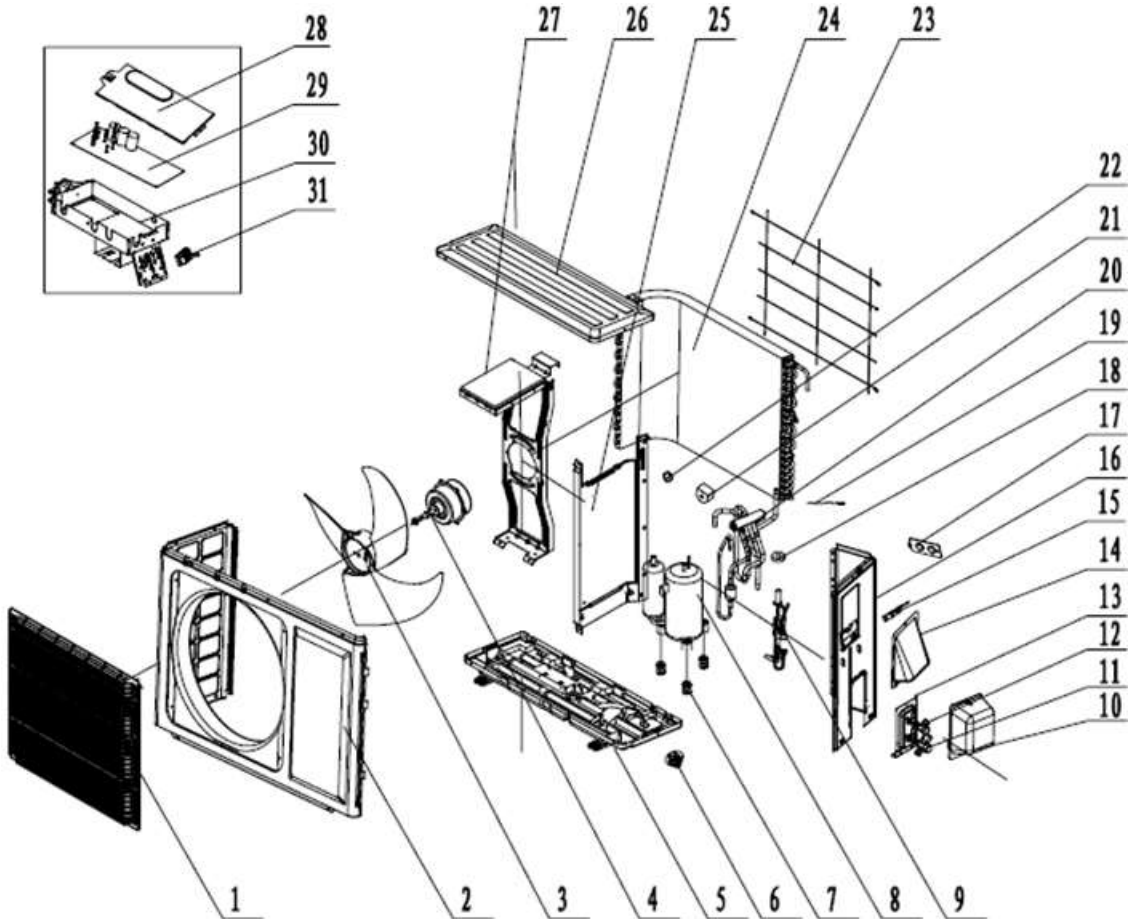

VIR12HP115V1AO
12,000 BTUH 115v Outdoor Unit
Product Code: GWH12QC-A3DNA1D/O

NO.	Part Code	Part Description	Qty
1	01473012	Front Grille	1
2	0153501604	Front Panel Assy	1
3	10333004	Axial Flow Fan	1
4	1501308505	Fan Motor	1
5	76510010	Basepan Heater	1
6	01203881P	Chassis Sub-Assy	1
7	06123401	Drainage Connector	1
8	76510009	Compressor Crankcase Heater	1
9	00103862	Compressor and Fittings	1
10	76710302	Compressor Grommet	3
Not Shown	03143102	Capillary Sub-Assy	1
11	4300040021	4-Way Valve Solenoid Coil	1
12	01713041	Valve Support	1
13	07100006	1/2-in Gas/Suction Valve	1
14	07130239	1/4-in Liquid Line Valve	1
15	22243010	Valve Cover	1
16	02123013P	Cable Cross Plate 1	1
17	02123014P	Cable Cross Plate 2	1
18	0130509901P	Right Side Plate	1
19	03073339	4-Way Valve Assy	1
20	430004022	4-Way Valve	1
Not Shown	07135228	Electronic Expansion Valve	1
21	03002600045	Electronic Expansion Valve Assy	1
22	4300876704	Electronic Expansion Valve Solenoid Coil	1
23	01475014	Rear Grille	1
24	01100200205	Condenser Coil Assy	1
25	00180030	Compressor Overload Protector(External)	1
Not Shown	00183032	Compressor Overload Protector(External)	1
Not Shown	00183031	Compressor Overload Protector(External)	1
26	01233090	Clapboard Sub-Assy	1
27	01253443	Top Cover Plate	1
29	0260309601	Electric Box Cover Sub-Assy	1
30	30138000545	Main Control Board	1
31	49010252	Heat Sink/Radiator	1
32	20113005	Electric Control Box 1	1
33	42010255	Terminal Board	1
34	01403767	Capacitor Box Sub-Assy	1
35	71010003	Wire Clamp	1
36	10000100184	Electric Control Box Assy	1
37	39000310	Temperature Sensor Assy **	1

** Temperature Sensor Assembly contains Discharge, Condenser Coil and Ambient sensors.

VIR12HP230V1AH

12,000 BTUH 208/230v Indoor Unit

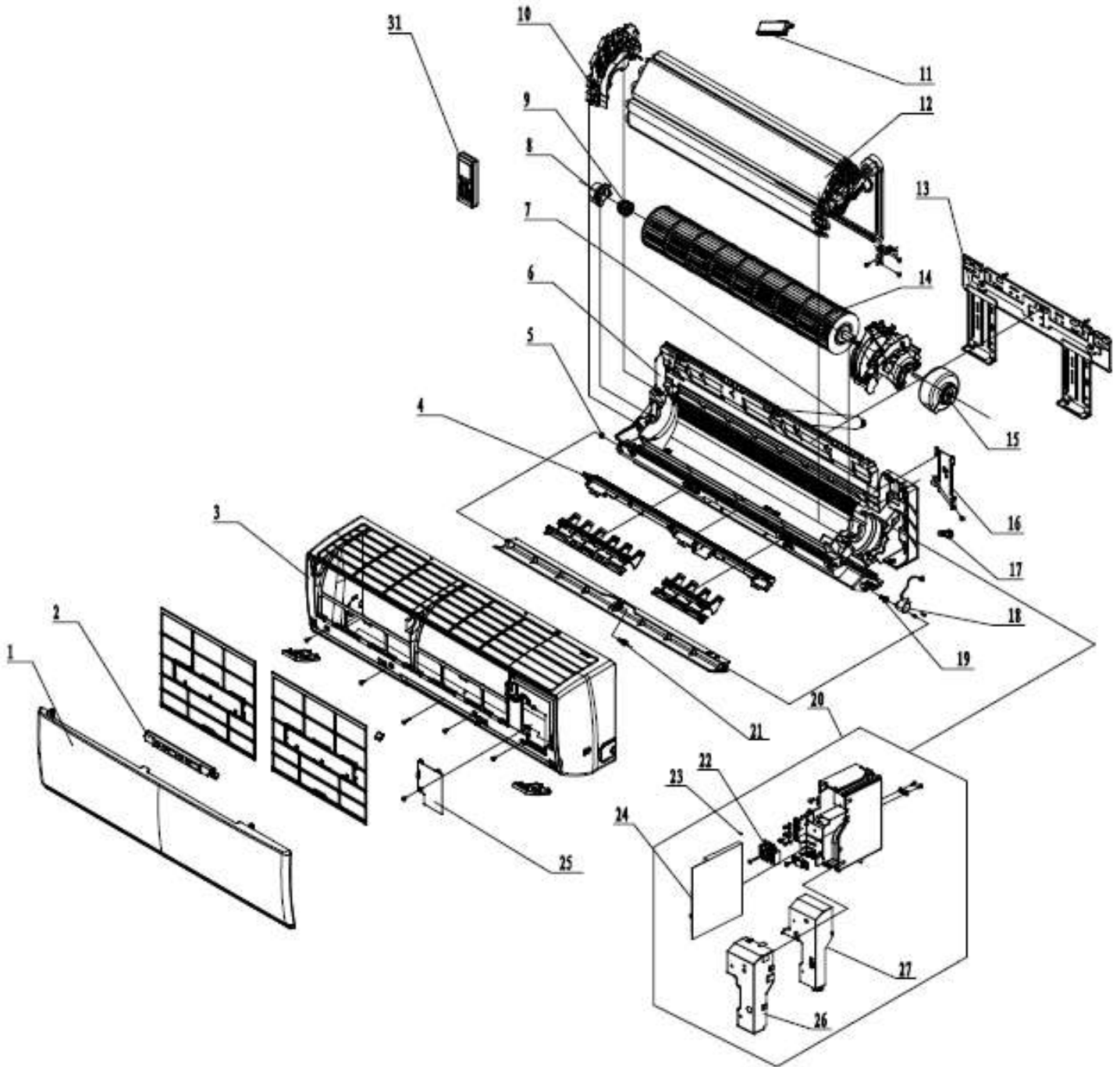

VIR12HP230V1AH
12,000 BTUH 208/230v Indoor Unit
Product Code: GWH12QC-D3DNB2D/I

NO.	Part Code	Part Description	Qty
1	20000300018S	Front Panel B2	1
Not Shown	11122468	Air Filter	2
2	30565260	Display Board	1
3	00000200045	Front Case Assy	1
4	26112436	Helicoid Tongue	1
5	10512037	Left Axial Bushing	1
6	00000100093	Rear Case Assy	1
7	05230014	Drainage Hose	1
8	26152022	Bearing Ring	1
9	7651205102	Bearing Ring O-Gasket Sub-Assy	1
10	24212174	Evaporator Support	1
12	0100200003001	Evaporator Coil Assy	1
13	01252484	Wall Mounting Bracket	1
14	10352056	Cross Flow Fan	1
15	1501246601	Fan Motor	1
16	2611216401	Condensate Pipe Clamp	1
17	76712012	Condensate Drain Plug	1
18	1521210701	Stepper Motor	1
19	73012005	Crank	1
20	10000201787	Electric Control Box Assy	1
21	10542036	Axial Bushing	1
22	42011233	Terminal Board	1
23	4202021920	Configuration Jumper	1
24	30138000318	Main Control Board	1
25	0140206501	Electric Box Cover Sub-Assy	1
26	01592150	Electric Box Shield Cover	1
27	2011220701	Electric Box Cover	1
Not Shown	3900031302	Ambient Temperature Sensor	1
Not Shown	3900031302	Indoor Coil Temperature Sensor	1
31	30510475	Remote Controller (YAN1F1F)	1
Not Shown	26150009	Remote Controller Holder/Cradle	1

VIR12HP230V1AO

12,000 BTUH 208/230v Outdoor Unit

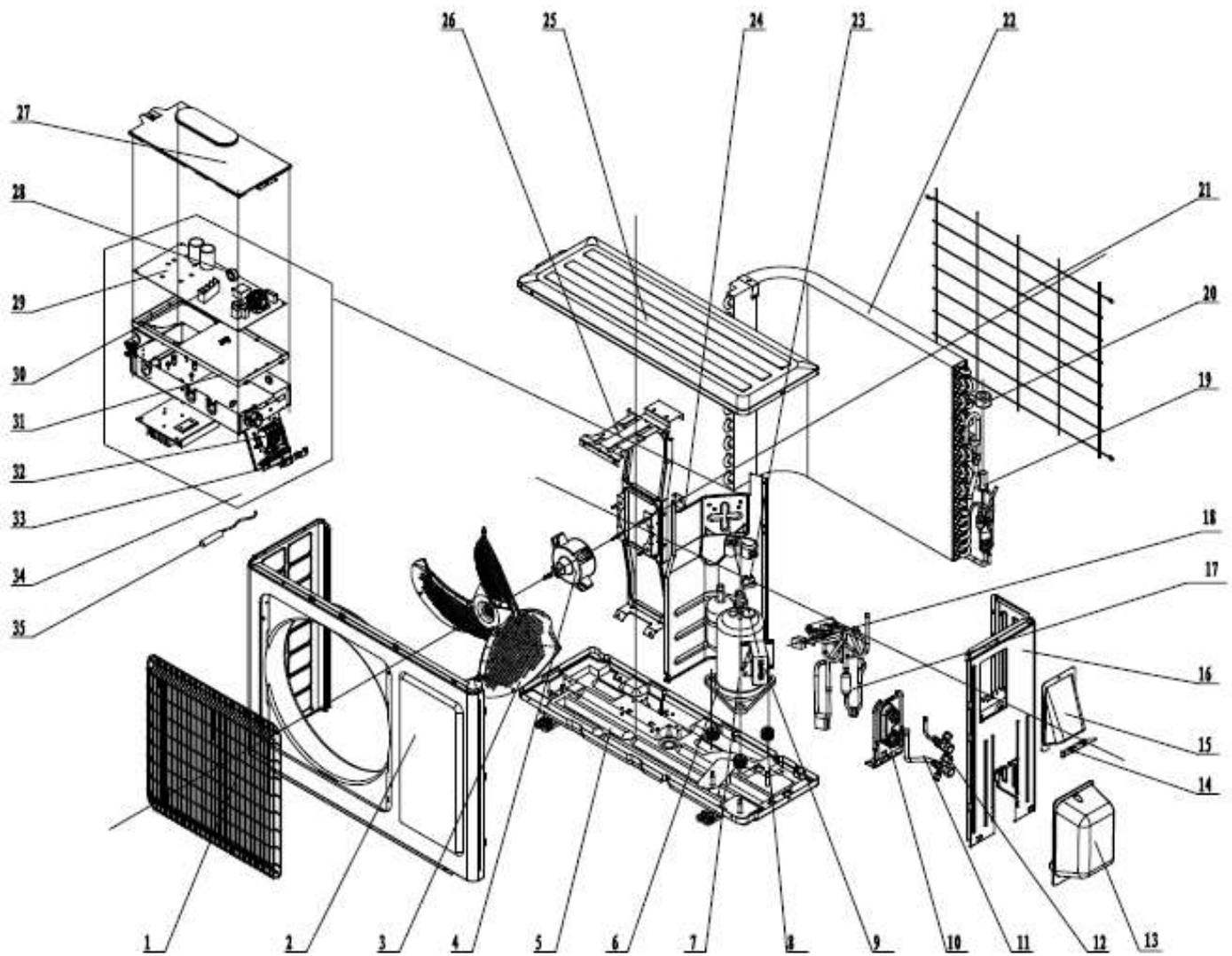

VIR12HP230V1AO
12,000 BTUH 208/230v Outdoor Unit
Product Code: GWH12QC-D3DNA1D/O

NO.	Part Code	Part Description	Qty
1	01473012	Front Grille	1
2	0153501604	Front Panel Assy	1
3	10333004	Axial Flow Fan	1
4	1501308505	Fan Motor	1
Not Shown	76513004	Basepan Heater	1
5	01700000053P	Chassis Sub-Assy	1
6	76513004	Compressor Crankcase Heater	1
7	00103892	Compressor and Fittings	1
8	76713027	Compressor Grommet	3
9	43130185	Reactor	1
10	01713041	Valve Support	1
11	07100006	1/2-in Gas/Suction Valve	1
12	07100003	1/4-in Liquid Line Valve	1
13	22243010	Valve Cover	1
14	02123013P	Cable Cross Plate 1	1
15	02123014P	Cable Cross Plate 2	1
16	0130509901P	Right Side Plate	1
Not Shown	430004032	4-Way Valve	1
17	03015200098	4-Way Valve Assy	1
18	4300040047	4-Way Valve Solenoid Coil	1
Not Shown	07130369	Electronic Expansion Valve	1
19	07133874	Electronic Expansion Valve Assy	1
20	4300876708	Electronic Expansion Valve Solenoid Coil	1
21	01475014	Rear Grille	1
22	0110020020701	Condenser Coil Assy	1
23	00183111	Compressor Overload Protector(External)	1
Not Shown	00183114	Compressor Overload Protector(External)	1
24	01233090	Clapboard Sub-Assy	1
25	01253443	Top Cover Plate	1
27	0260309601	Electric Box Cover Sub-Assy	1
28	49010104	Magnetic Ring	1
29	30138000519	Main Control Board	1
30	49013026	Heat Sink/Radiator	1
31	20113005	Electric Control Box 1	1
32	42010313	Terminal Board	1
33	71010003	Wire Clamp	2
34	10000100190	Electric Control Box Assy	1
35	39000310	Temperature Sensor Assy **	1

** Temperature Sensor Assembly contains Discharge, Condenser Coil and Ambient sensors.

VIR18HP230V1AH

18,000 BTUH 208/230v Indoor Unit

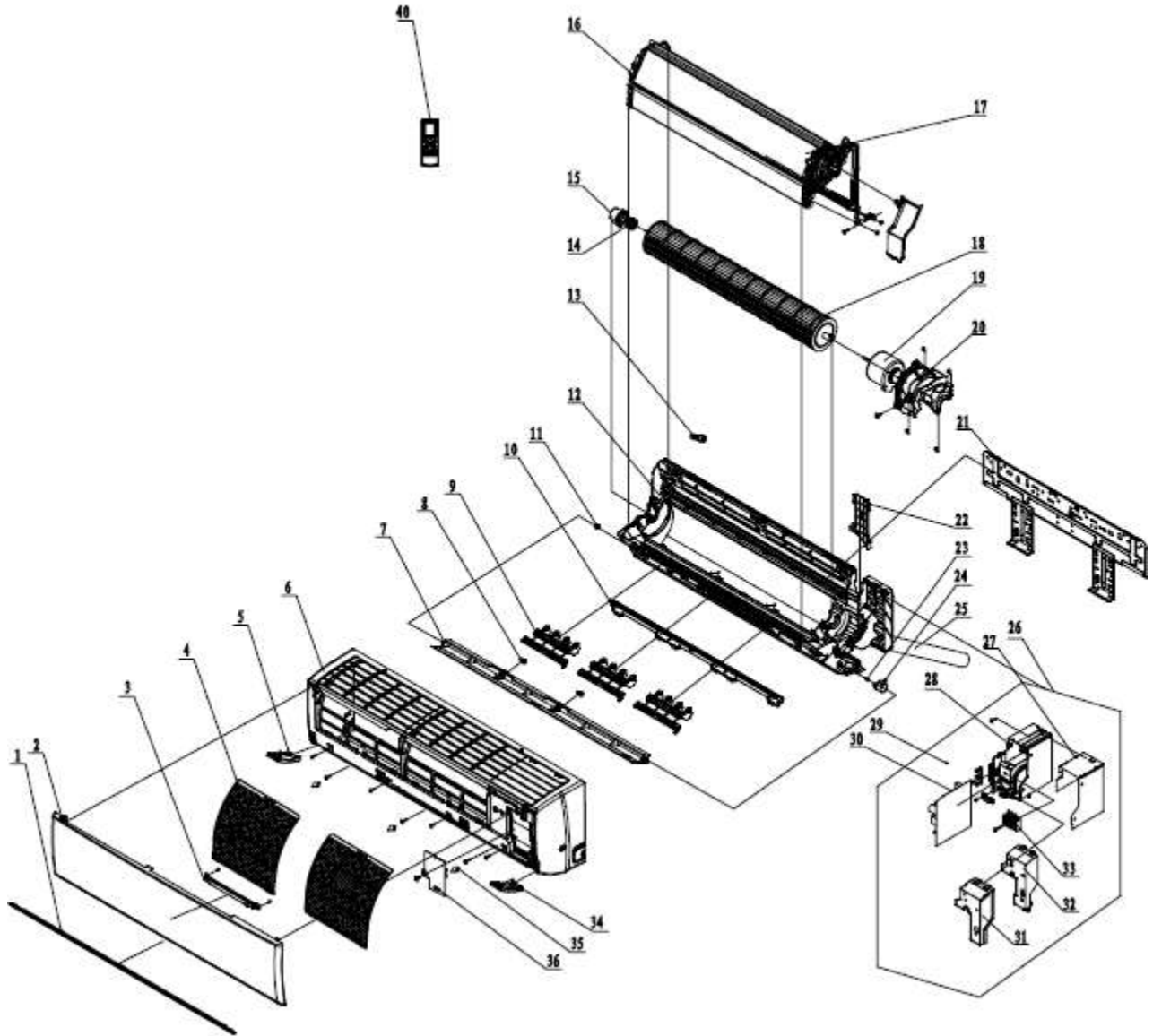

VIR18HP230V1AH
18,000 BTUH 208/230v Indoor Unit
Product Code: GWH18QD-D3DNB2G/I

NO.	Part Code	Part Description	Qty
1	none	Decorative Strip	0
2	20000300023S	Front Panel	1
3	30565260	Display Board	1
4	1112208904	Air Filter	2
5	20192662	Decorative Board (Right)	1
6	00000200042	Front Case Assy	1
7	1051276501	Guide Louver	1
8	10542036	Axial Bushing	2
9	10512732	Air Louver (Manual)	3
10	26112512	Helicoid Tongue	1
11	10512037	Left Axial Bushing	1
12	22202571	Rear Case Assy	1
13	76712012	Condensate Drain Plug	1
14	7651205102	Bearing Ring O-Gasket Sub-Assy	1
15	26152025	Bearing Ring	1
16	24212177	Evaporator Support	1
17	01100100085	Evaporator Coil Assy	1
18	10352060	Cross Flow Fan	1
19	15012136	Fan Motor	1
20	26112511	Motor Press Plate	1
21	01362026	Wall Mounting Bracket	1
22	2611218801	Condensate Pipe Clamp	1
23	73012005	Crank	1
24	1521240212	Stepper Motor	1
25	05230014	Drainage Hose	1
26	10000203322	Electric Control Box Assy	1
27	01592139	Lower Electric Box Shield	1
28	2011221102	Electric Box	1
29	4202021924	Configuration Jumper	1
30	30138000318	Main Control Board	1
31	01592140	Electric Box Shield Cover	1
32	2011220901	Electric Box Cover	1
33	4201123303	Terminal Board	1
35	2425201726	Screw Cover	3
36	2011221001	Electric Box Cover 2	1
Not Shown	3900031302	Ambient Temperature Sensor	1
Not Shown	3900031302	Indoor Coil Temperature Sensor	1
40	30510475	Remote Controller (YAN1F1F)	1
Not Shown	26150009	Remote Controller Holder/Cradle	1

VIR18HP230V1AO

18,000 BTUH 208/230v Outdoor Unit

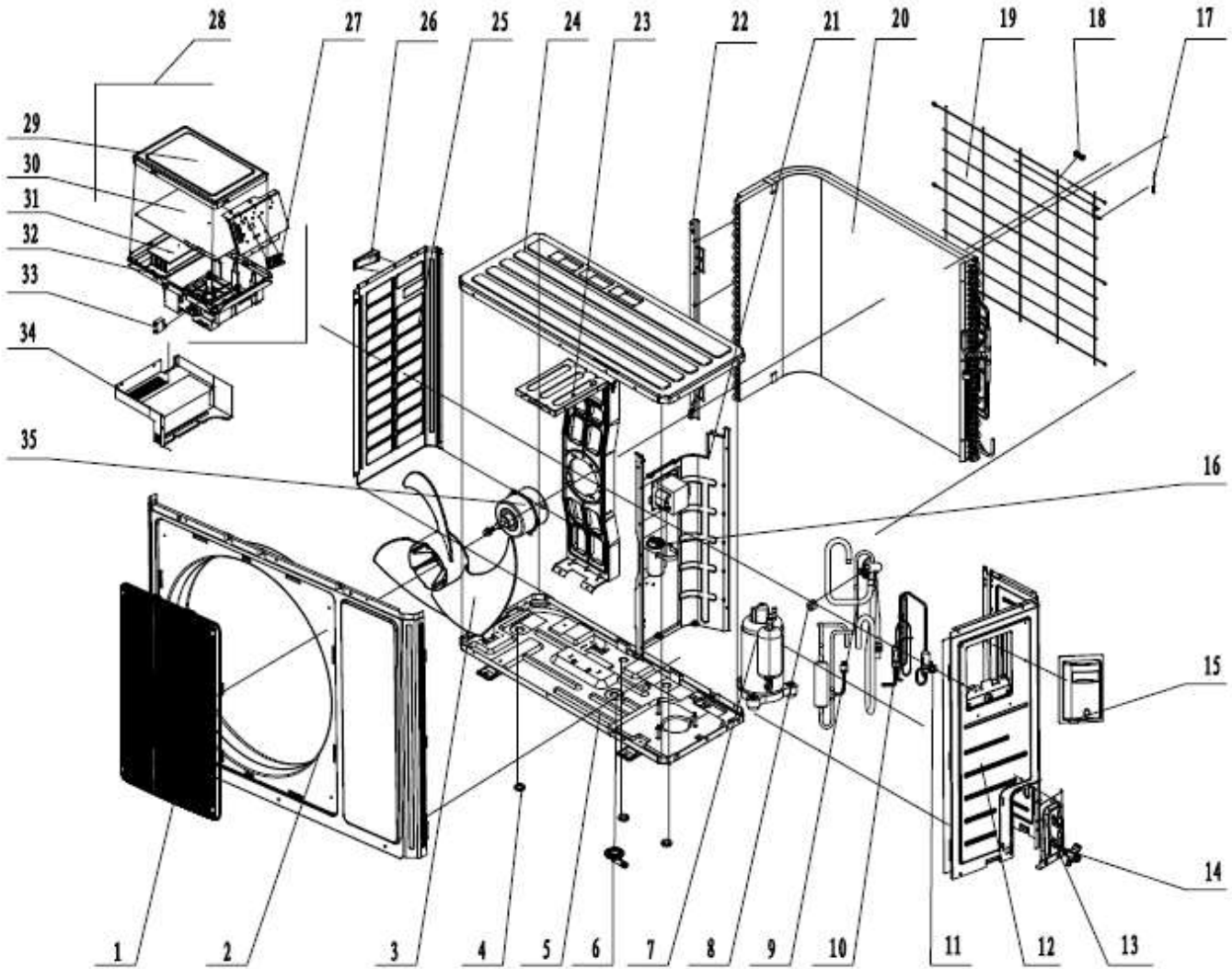

VIR18HP230V1AO
18,000 BTUH 208/230v Outdoor Unit
Product Code: GWH18QD-D3DNA1G/O

NO.	Part Code	Part Description	Qty
1	01473049	Front Grille	1
2	0000030002401	Front Panel Assy	1
3	10335008	Axial Flow Fan	1
5	01700000161P	Chassis Sub-Assy	1
Not Shown	7651000411	Basepan Heater	1
6	06123401	Drainage Connector	1
7	00105249G	Compressor and Fittings	1
Not Shown	00180030	Compressor Overload Protector(External)	1
Not Shown	00183051	Compressor Overload Protector(External)	1
Not Shown	00183032	Compressor Overload Protector(External)	1
Not Shown	07130369	Electronic Expansion Valve	1
Not Shown	4300876705	Electronic Expansion Valve Solenoid Coil	1
8	430004032	4-Way Valve	1
9	03073411	4-Way Valve Assy	1
Not Shown	4300040078	4-Way Valve Solenoid Coil	1
10	03015737	Capillary Sub-Assy	1
11	07130239	1/4-in Liquid Line Valve	1
12	0130509002P	Right Side Plate	1
13	01705046P	Valve Support Sub-Assy	1
14	07133844	1/2-in Gas/Suction Valve	1
15	02113109	Handle Assy	1
17	3900030902	Temperature Sensor Assy**	1
19	01475020	Rear Grille	1
20	01103000090	Condenser Coil Assy	1
21	01235081	Clapboard Sub-Assy	1
22	01795031	Condenser Support Plate	1
23	01705067	Motor Support Sub-Assy	1
24	01255005P	Top Cover	1
25	01305093P	Left Side Plate	1
27	4201025501	Terminal Board	1
28	10000100632	Electric Control Box Assy	1
29	20125002	Electric Box Cover	1
30	30138000873	Main Control Board	1
31	49010252	Heat Sink/Radiator	1
32	20115003	Electric Box	1
35	1501506402	Fan Motor	1

** Temperature Sensor Assembly contains Discharge, Condenser Coil and Ambient sensors.

VIR24HP230V1AH

24,000 BTUH 208/230v Indoor Unit

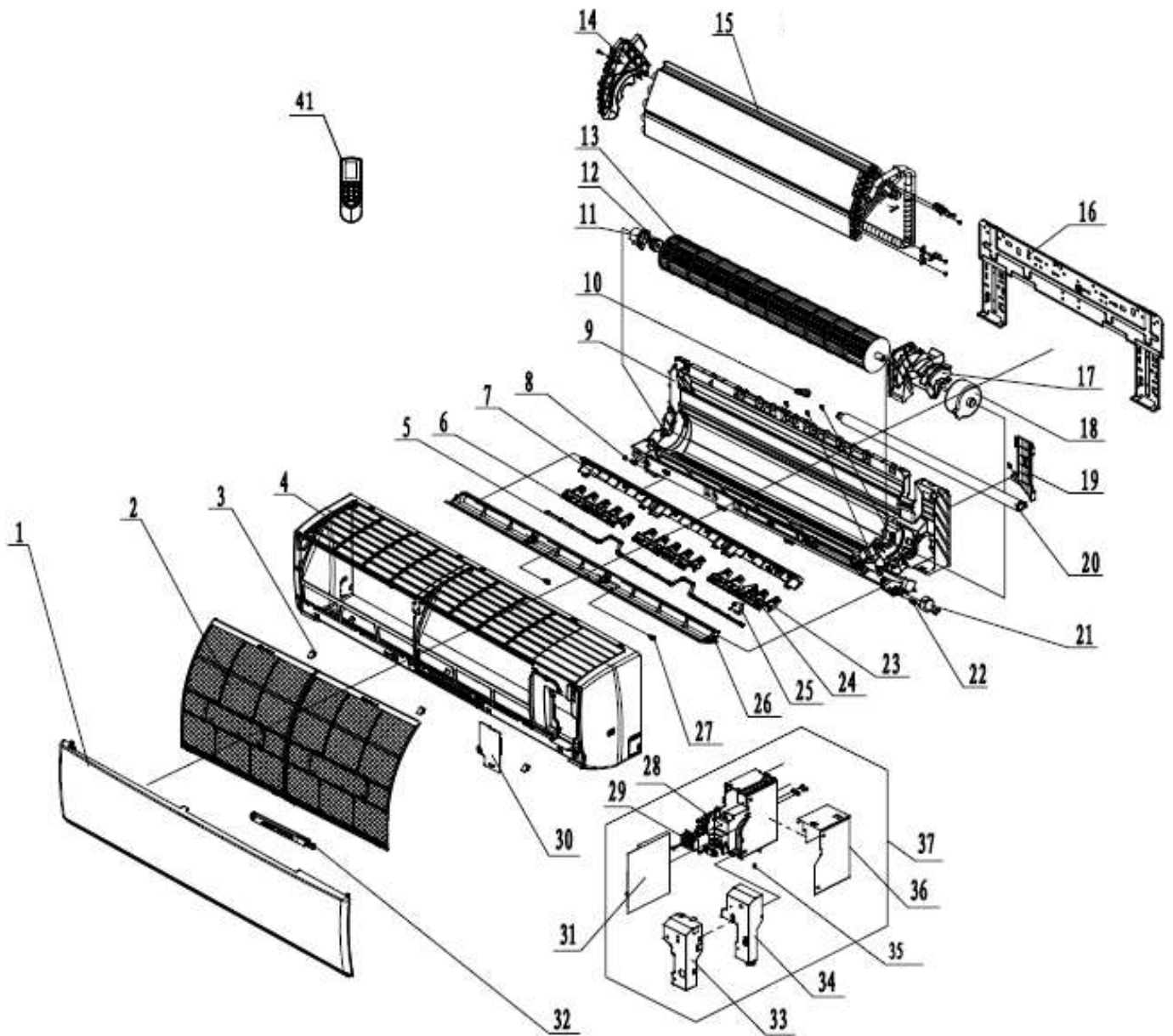

VIR24HP230V1AH
24,000 BTUH 208/230v Indoor Unit
Product Code: GWH24QE-D3DNB2D/I

NO.	Part Code	Part Description	Qty
1	20000300016S	Front Panel	1
2	11012007	Air Filter	2
3	2425245301	Screw Cover	3
4	00000200057	Front Case Assy	1
7	26112382	Helicoid Tongue Sub-Assy	1
8	10512037	Left Axial Bushing	1
9	22202570	Rear Case Assy	1
10	76712012	Condensate Drain Plug	1
11	26152025	Bearing Ring	1
12	7651205102	Bearing Ring O-Gasket Sub-Assy	1
13	10352057	Cross Flow Fan	1
14	24212178	Evaporator Support	1
15	01100100029	Evaporator Coil Assy	1
16	01252229	Wall Mounting Bracket	1
17	26112515	Motor Press Plate	1
18	15012136	Fan Motor	1
19	26112514	Condensate Pipe Clamp	1
20	0523001405	Drainage Hose	1
21	1521240212	Stepper Motor	1
22	73012005	Crank	1
24	10512737	Air Louver(Manual)	3
26	1051232001	Guide Louver	1
27	10542036	Axial Bushing	2
28	2011221102	Electric Control Box	1
29	42011233	Terminal Board	1
30	2011221001	Electric Box Cover 2	1
31	30138000318	Main Control Board	1
32	30565260	Display Board	1
33	01592140	Electric Box Shield Cover	1
34	2011220901	Electric Box Cover	1
35	4202021926	Configuration Jumper	1
36	01592139	Lower Electric Box Shield	1
37	10000201790	Electric Control Box Assy	1
40	3900031302	Ambient Temperature Sensor	1
Not Shown	3900031302	Indoor Coil Temperature Sensor	1
41	30510475	Remote Controller (YAN1F1F)	1
Not Shown	26150009	Remote Controller Holder/Cradle	1

VIR24HP230V1AO

24,000 BTUH 208/230v Outdoor Unit

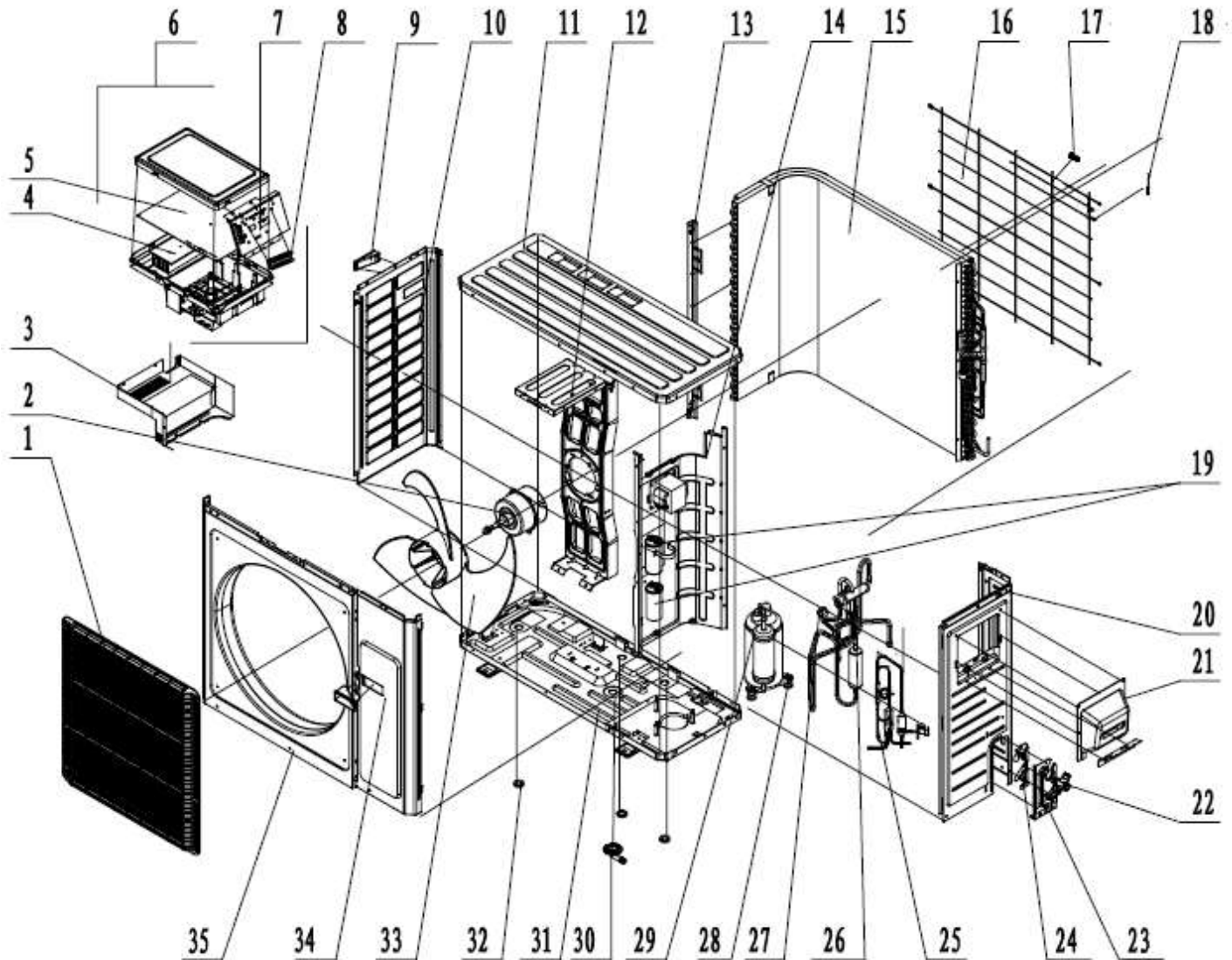

VIR24HP230V1AO
24,000 BTUH 208/230v Outdoor Unit
Product Code: GWH24QE-D3DNA1D/O

NO.	Part Code	Part Description	Qty
1	01473050	Front Grille	1
2	1501403402	Fan Motor	1
3	01413426	Electric Box (Fireproofing)	1
4	49015215	Heat Sink/Radiator	1
5	30138000504	Main Control Board	1
6	10000100164	Electric Control Box Assy	1
8	42010255	Terminal Board	1
10	01305043P	Left Side Plate	1
11	01255006P	Top Cover	1
12	01705025	Motor Support Sub-Assy	1
13	01175092	Condenser Support Plate	1
14	01235040	Clapboard Sub-Assy	1
15	01100200162	Condenser Coil Assy	1
16	01475013	Rear Grille	1
17	26115004	Wiring Clamp	1
18	3900030901	Temperature Sensor Assy **	1
20	0130504402P	Right Side Plate	1
21	02115005	Big Handle	1
Not Shown	07130239	1/4-in Liquid Line Valve	1
22	07133157	5/8-in Gas/Suction Valve	1
23	0171501201P	Valve Support Sub-Assy	1
24	01365435P	Baffle (Valve Support)	1
25	03015737	Capillary Sub-Assy	1
Not Shown	4300008201	4-Way Valve	1
26	03015200087	4-Way Valve Assy	1
27	4300040045	4-Way Valve Solenoid Coil	1
28	76713066	Compressor Grommet	3
29	0010505701	Compressor and Fittings	1
Not Shown	00180030	Compressor Overload Protector(External)	1
Not Shown	00183051	Compressor Overload Protector(External)	1
Not Shown	00183032	Compressor Overload Protector(External)	1
Not Shown	07133909	Electronic Expansion Valve	1
Not Shown	4300876704	Electronic Expansion Valve Solenoid Coil	1
30	06123401	Drainage Connector	1
31	0280319604P	Chassis Sub-Assy	1
32	none	Drainage Plug	0
Not Shown	7651000411	Basepan Heater	1
33	10335014	Axial Flow Fan	1
34	01303249P	Front Side Plate Sub-Assy	1
35	0153501405	Front Panel Assy	1

** Temperature Sensor Assembly contains Discharge, Condenser Coil and Ambient sensors.

VIR30HP230V1AH

30,000 BTUH 208/230v Indoor Unit

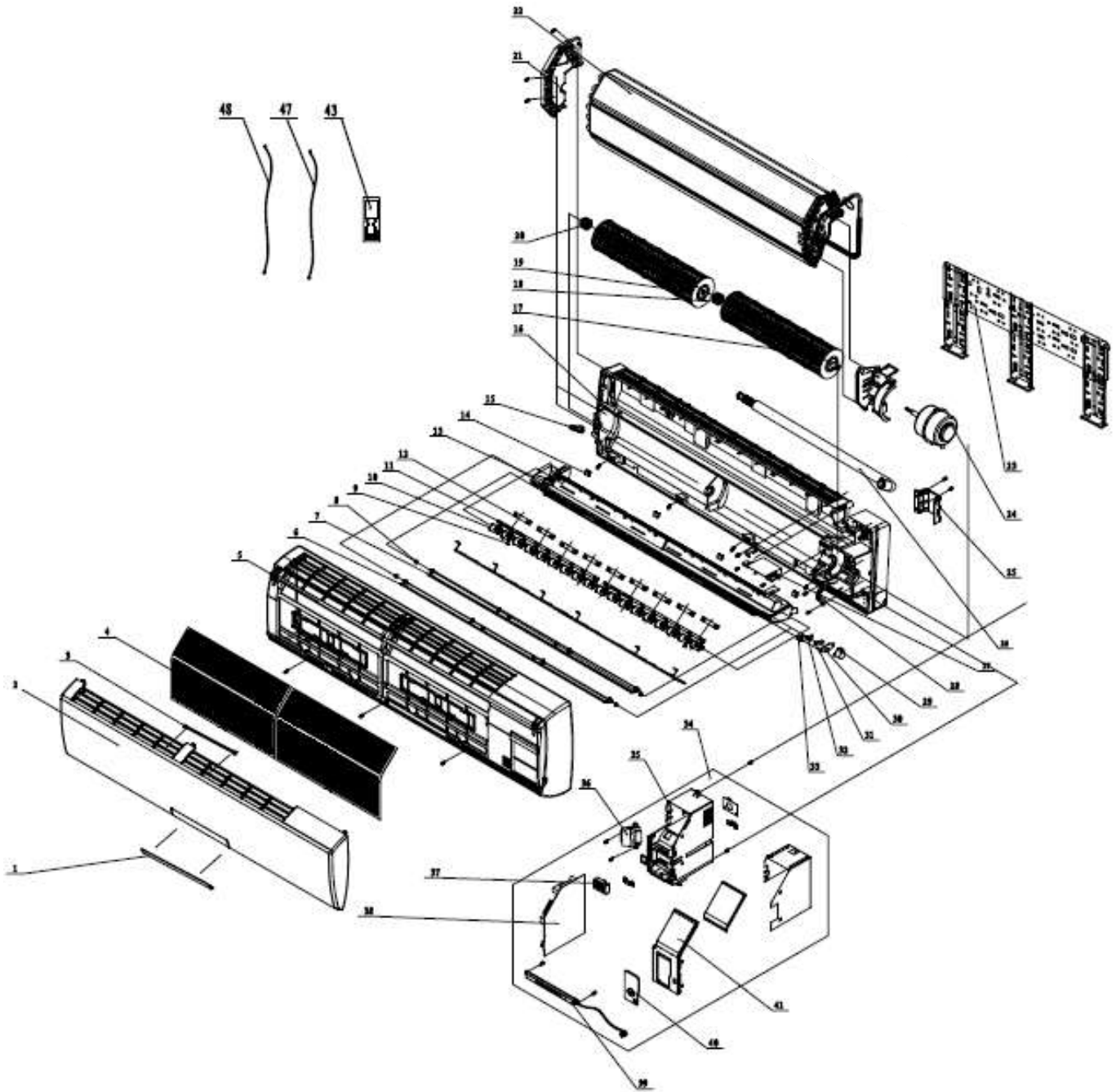

VIR30HP230V1AH
30,000 BTUH 208/230v Indoor Unit
Product Code: GWH30LB-D3DNB2G/I

NO.	Part Code	Part Description	Qty
1	22430024	Receiver Window	1
2	20000300022S	Front Panel	1
3	2421212001	Kick Stand Bar	1
4	11122106	Air Filter	2
5	20900700005	Front Case Sub-Assy	1
6	1051216601	Upper Guide Louver	1
7	1051216701	Lower Guide Louver	1
8	10542704	Axial Bushing	6
9	1051216902	Air Louver 2	2
10	1051216802	Air Louver 1	16
11	10582086	Connecting Rod	2
12	26112158	Louver Clamp	9
13	2018213802	Condensate Water Tray	1
14	2425200506	Screw Cover	4
15	76712012	Condensate Drain Plug	1
16	00000100113	Rear Case Assy	1
17	10352039	Cross Flow Fan 1	1
18	26152028	Bearing Holder Sub-Assy	1
19	10352040	Cross Flow Fan 2	1
20	76512051	Bearing Ring O-Gasket Sub-Assy	1
21	24212041	Left Evaporator Support	1
22	01002000027	Evaporator Coil Assy	1
23	01252398	Wall Mounting Bracket	1
24	1501213401	Fan Motor	1
25	26112071	Condensate Pipe Clamp	1
26	0523001404	Condensate Drainage Hose	1
27	2012212402	Cover Plate	1
28	26112324	Motor Fixed Clip 1	1
29	1521210701	Stepper Motor	1
30	26112070	Press Plate (Crank)	1
31	10582041	Crank-Guide	1
32	10562004	Upper Crank	1
33	10562005	Lower Crank	1
34	10000202639	Electric Control Box Assy	1
35	201022502	Electric Control Box	1
37	4201123303	Terminal Board	1
38	30138000192	Main Control Board	1
40	201022523	Electric Box Cover	1
41	2011204404S	Electric Box Cover 1	1
42	30565277	Display Board	1
43	30510475	Remote Controller (YAN1F1F)	1
Not Shown	26150009	Remote Controller Holder/Cradle	1
47	390000592	Indoor Coil Temperature Sensor	1
48	390000453	Ambient Temperature Sensor	1

VIR30HP230V1AO

30,000 BTUH 208/230v Outdoor Unit

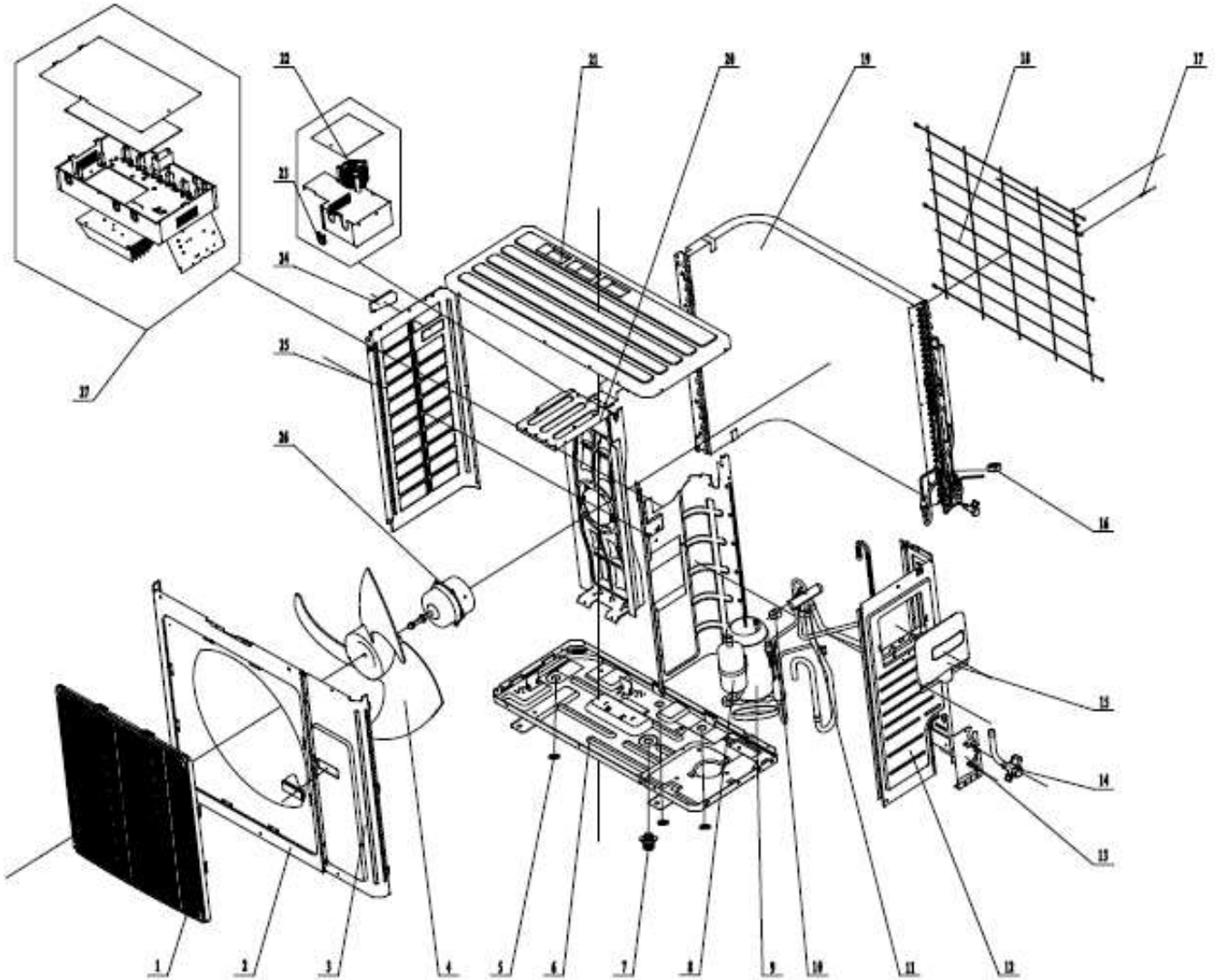

VIR30HP230V1AO
30,000 BTUH 208/230v Outdoor Unit
Product Code: GWH30LB-D3DNA3G/O

NO.	Part Code	Part Description	Qty
1	01473050	Front Grille	1
2	0153501405	Front Panel Assy	1
3	01303249P	Front Side Plate Sub-Assy	1
Not Shown	765100047	Basepan Heater	1
4	10335014	Axial Flow Fan	1
5	none	Drainage Plug	0
6	02803101P	Chassis Sub-Assy	1
7	06123401	Drainage Connector	1
8	00105051	Compressor and Fittings	1
Not Shown	00180030	Compressor Overload Protector(External)	1
Not Shown	00183051	Compressor Overload Protector(External)	1
Not Shown	00183032	Compressor Overload Protector(External)	1
9	7651873209	Compressor Crankcase Heater	1
Not Shown	81028009	Capillary Sub-Assy	1
10	4300040029	4-Way Valve Solenoid Coil	1
11	03123895	4-Way Valve Assy	1
Not Shown	4300008201	4-Way Valve	1
12	0130504402P	Right Side Plate	1
13	0171501201P	Valve Support Sub-Assy	1
Not Shown	07130239	1/4-in Liquid Line Valve	1
14	07133157	5/8-in Gas/Suction Valve	1
15	02115005	Big Handle	1
Not Shown	07138807	Electronic Expansion Valve	1
16	4300876703	Electronic Expansion Valve Solenoid Coil	1
17	3900031001	Temperature Sensor Assy **	1
18	01475013	Rear Grille	1
19	01163509	Condenser Coil Assy	1
20	0180287601	Motor Support Sub-Assy	1
21	01255007	Top Cover Sub-Assy	1
23	76614102	Pass Wire Ring Sub-Assy	2
25	01305043P	Left Side Plate	1
26	15702802	Fan Motor	1
27	10000100310	Electric Control Box Assy	1
Not Shown	46020006	High Pressure Switch	1
Not Shown	30148338	Main Control Board	1

** Temperature Sensor Assembly contains Discharge, Condenser Coil and Ambient sensors.

VIR36HP230V1AH

36,000 BTUH 208/230v Indoor Unit

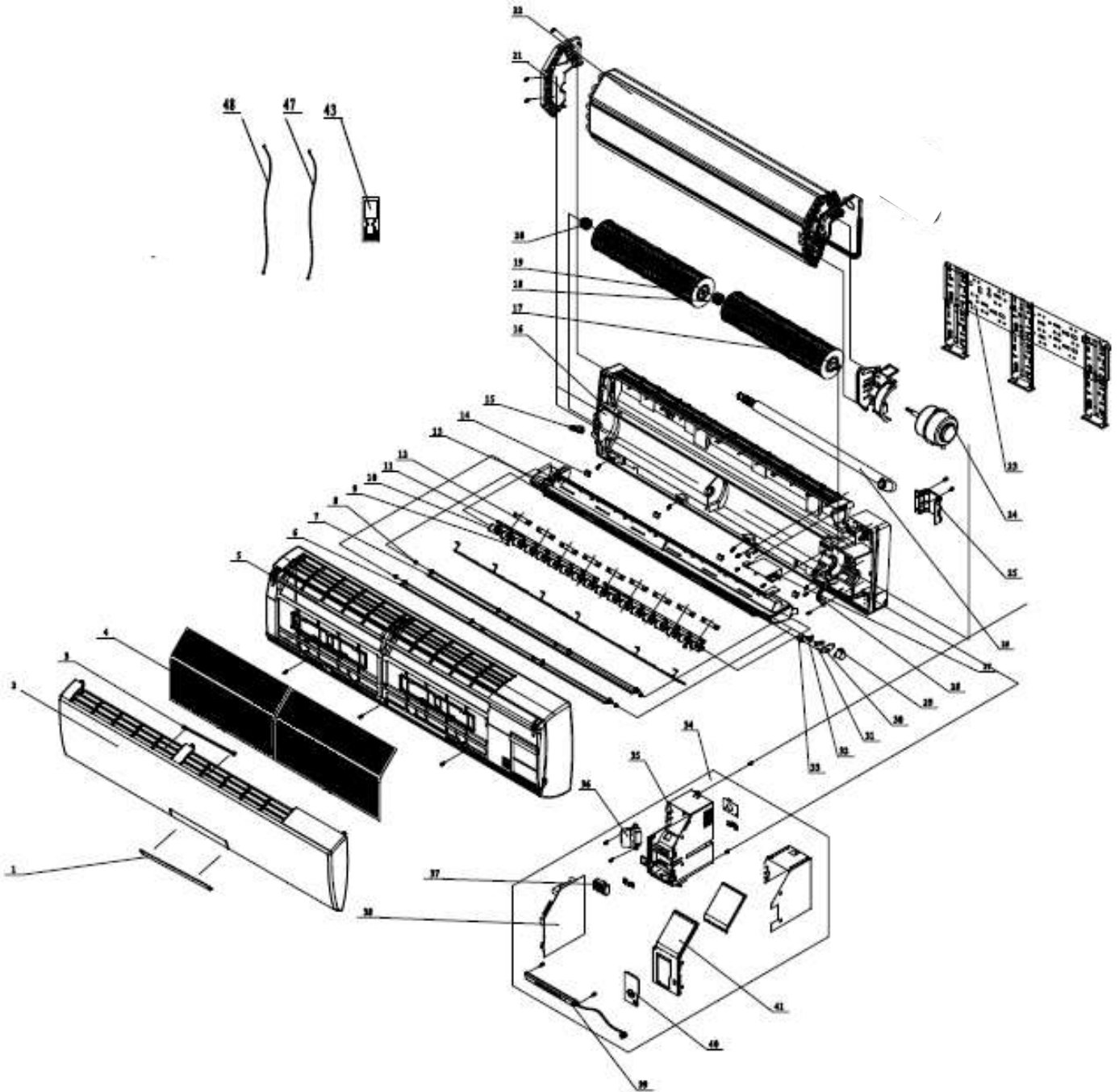

VIR36HP230V1AH
36,000 BTUH 208/230v Indoor Unit
Product Code: GWH36LB-D3DNB2G/I

NO.	Part Code	Part Description	Qty
1	22430024	Receiver Window	1
2	20000300022S	Front Panel	1
3	2421212001	Kick Stand Bar	1
4	11122106	Air Filter	2
5	20900700005	Front Case Sub-Assy	1
6	1051216601	Upper Guide Louver	1
7	1051216701	Lower Guide Louver	1
8	10542704	Axial Bushing	6
9	1051216902	Air Louver 2	2
10	1051216802	Air Louver 1	16
11	10582086	Connecting Rod	2
12	26112158	Louver Clamp	9
13	2018213802	Condensate Water Tray	1
14	2425200506	Screw Cover	4
15	76712012	Condensate Drain Plug	1
16	00000100113	Rear Case Assy	1
17	10352039	Cross Flow Fan 1	1
18	26152028	Bearing Holder Sub-Assy	1
19	10352040	Cross Flow Fan 2	1
20	76512051	Bearing Ring O-Gasket Sub-Assy	1
21	24212041	Left Evaporator Support	1
22	01002000027	Evaporator Coil Assy	1
23	01252398	Wall Mounting Bracket	1
24	1501213401	Fan Motor	1
25	26112071	Condensate Pipe Clamp	1
26	0523001404	Drainage Hose	1
27	2012212402	Cover Plate	1
28	26112324	Motor Fixed Clip 1	1
29	1521210701	Stepper Motor	1
30	26112070	Press Plate(Crank)	1
31	10582041	Crank-Guide	1
32	10562004	Upper Crank	1
33	10562005	Lower Crank	1
34	10000202641	Electric Control Box Assy	1
35	201022502	Electric Control Box	1
37	4201123303	Terminal Board	1
38	30138000192	Main Control Board	1
40	201022523	Electric Box Cover	1
41	2011204404S	Electric Box Cover	1
42	30565277	Display Board	1
43	30510475	Remote Controller (YAN1F1F)	1
Not Shown	26150009	Remote Controller Holder/Cradle	1
47	390000592	Indoor Coil Temperature Sensor	1
48	390000453	Ambient Temperature Sensor	1

VIR36HP230V1AO

36,000 BTUH 208/230v Outdoor Unit

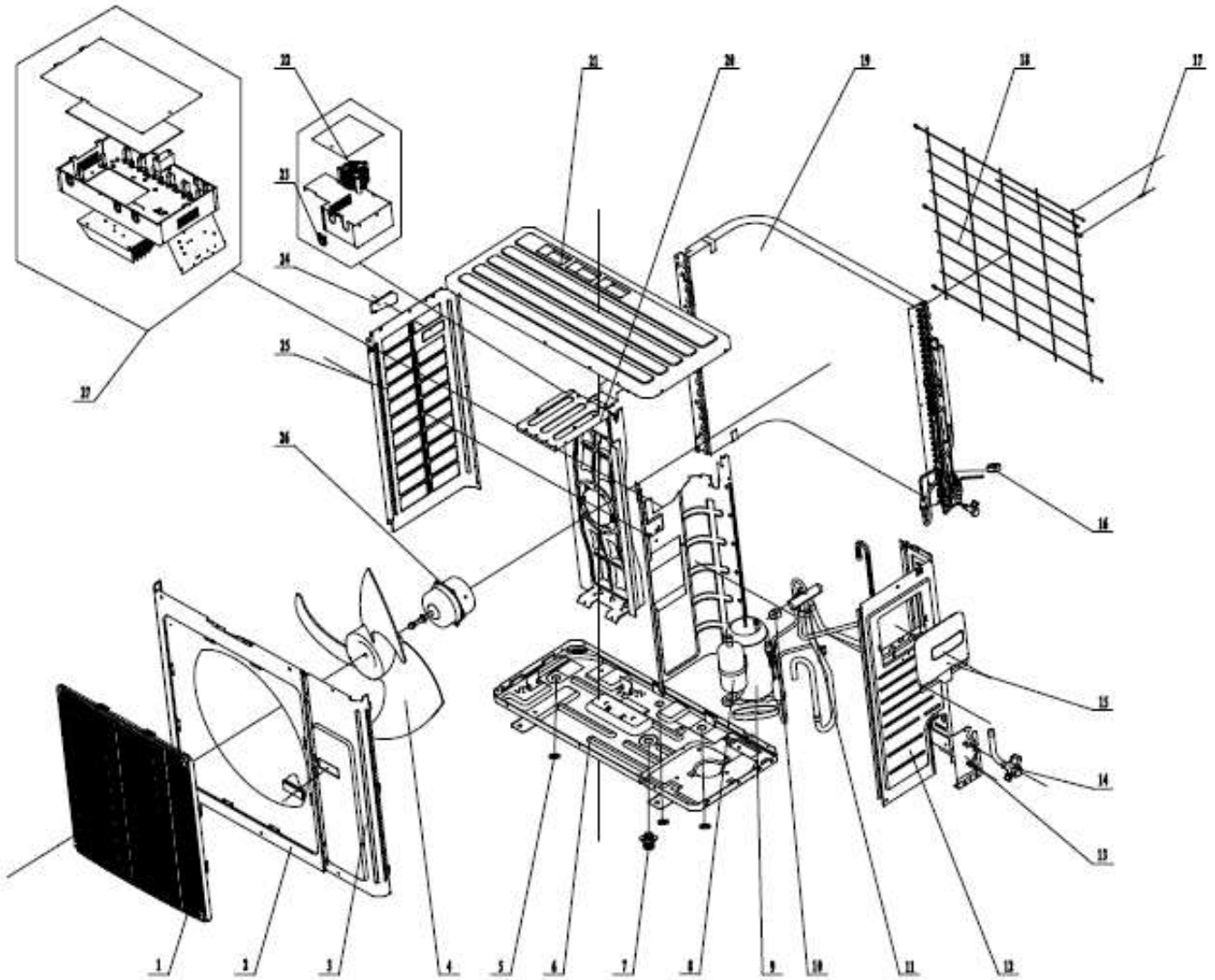

VIR36HP230V1AO
36,000 BTUH 208/230v Outdoor Unit
Product Code: GWH36LB-D3DNA3G/O

NO.	Part Code	Part Description	Qty
1	01473050	Front Grille	1
2	0153501405	Front Panel Assy	1
3	01303249P	Front Side Plate Sub-Assy	1
Not Shown	7651000413	Basepan Heater	1
4	10335014	Axial Flow Fan	1
5	none	Drainage Plug	0
6	02803026P	Chassis Sub-Assy	1
7	06123401	Drainage Connector	1
8	00205275	Compressor	1
Not Shown	00185012	Compressor Overload Protector(External)	1
9	7651873209	Compressor Crankcase Heater	1
10	4300040029	4-Way Valve Solenoid Coil	1
11	03123890	4-Way Valve Assy	1
Not Shown	43000338	4-Way Valve	1
12	0130504402P	Right Side Plate	1
13	0171501201P	Valve Support Sub-Assy	1
Not Shown	07130239	1/4-in Liquid Line Valve	1
14	07133157	1/2-in Gas/Suction Valve	1
15	02115005	Big Handle	1
Not Shown	07138807	Electronic Expansion Valve Assy	1
16	4300876703	Electronic Expansion Valve Solenoid Coil	1
17	3900031001	Temperature Sensor Assy **	1
18	01475013	Rear Grille	1
19	01163491	Condenser Coil Assy	1
20	01802876	Motor Support Sub-Assy	1
21	01255007	Top Cover Sub-Assy	1
23	76614102	Pass Wire Ring Sub-Assy	2
25	01305043P	Left Side Plate	1
26	1570280205	Fan Motor	1
27	10000100328	Electric Control Box Assy	1
Not Shown	46020006	High Pressure Switch	1
Not Shown	30138000711	Main Control Board	1

** Temperature Sensor Assembly contains Discharge, Condenser Coil and Ambient sensors.

VIR09HP115V1BH

9,000 BTUH 115v Indoor Unit

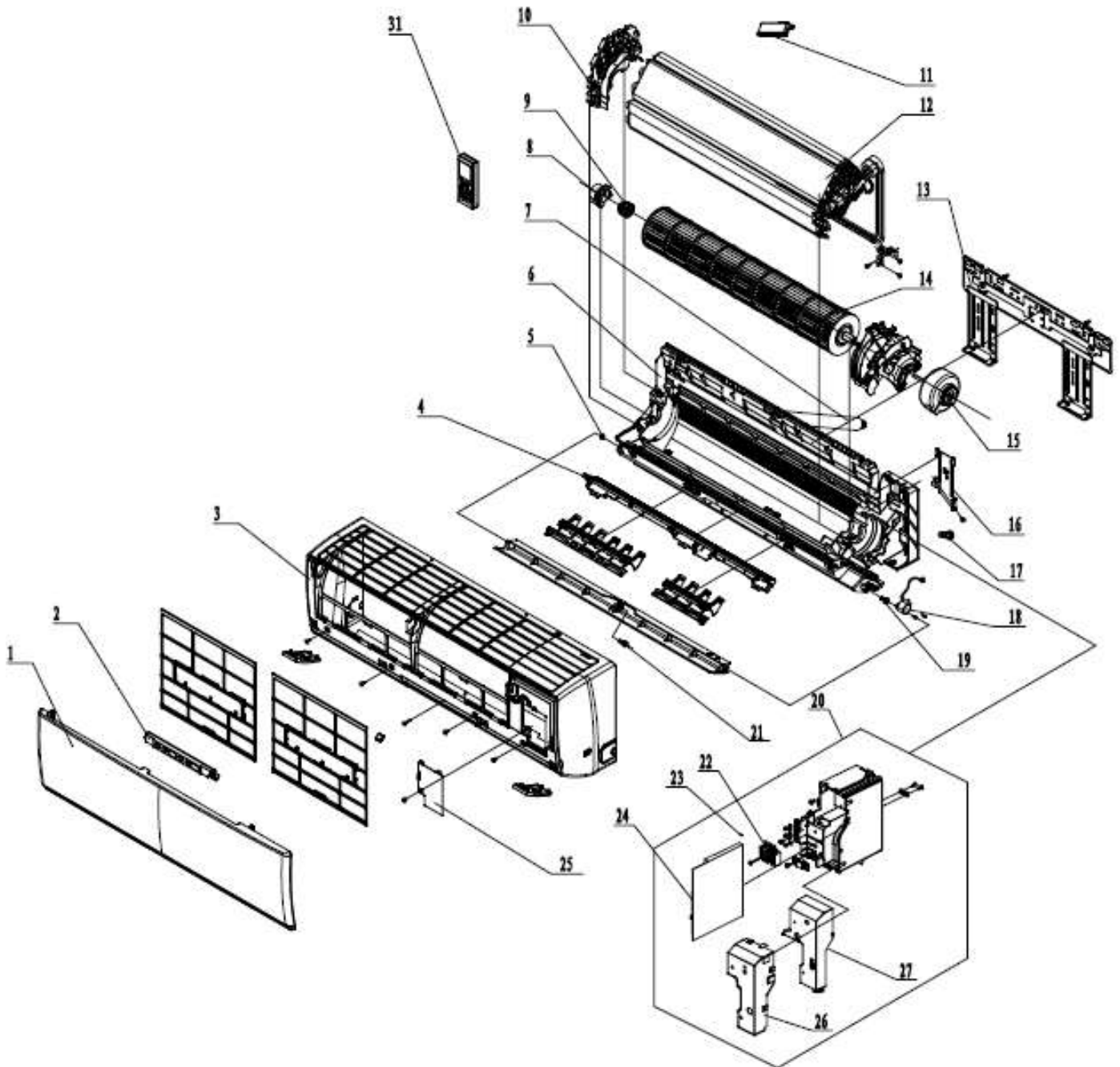

VIR09HP115V1BH
9,000 BTUH 115v Indoor Unit
Product Code: GWH09QC-A3DNB2D/I

NO.	Part Code	Part Description	Qty
1	20000300018S	Front Panel B2	1
Not Shown	11122468	Air Filter	2
2	30565260	Display Board	1
3	00000200045	Front Case Assy	1
4	26112436	Helicoid Tongue	1
5	10512037	Left Axial Bushing	1
6	00000100093	Rear Case Assy	1
7	05230014	Drainage Hose	1
8	26152022	Bearing Ring	1
9	7651205102	Bearing Ring O-Gasket Sub-Assy	1
10	24212174	Evaporator Support	1
12	01002000030	Evaporator Coil Assy	1
13	01252484	Wall Mounting Bracket	1
14	10352056	Cross Flow Fan	1
15	15012153	Fan Motor	1
16	2611216401	Condensate Pipe Clamp	1
17	76712012	Condensate Drain Plug	1
18	1521210710	Stepper Motor	1
19	73012005	Crank	1
20	100002002094	Electric Control Box Assy	1
21	10542036	Axial Bushing	1
22	42011233	Terminal Board	1
23	4202021909	Configuration Jumper	1
24	30138001018	Main Control Board	1
25	0140206501	Electric Box Cover Sub-Assy	1
26	01592150	Electric Box Shield Cover	1
27	2011220701	Electric Box Cover	1
Not Shown	3900031302	Ambient Temperature Sensor	1
Not Shown	3900031302	Indoor Coil Temperature Sensor	1
31	30510475	Remote Controller (YAN1F1F)	1
Not Shown	26150009	Remote Controller Holder/Cradle	1

VIR09HP115V1BO

9,000 BTUH 115v Outdoor Unit

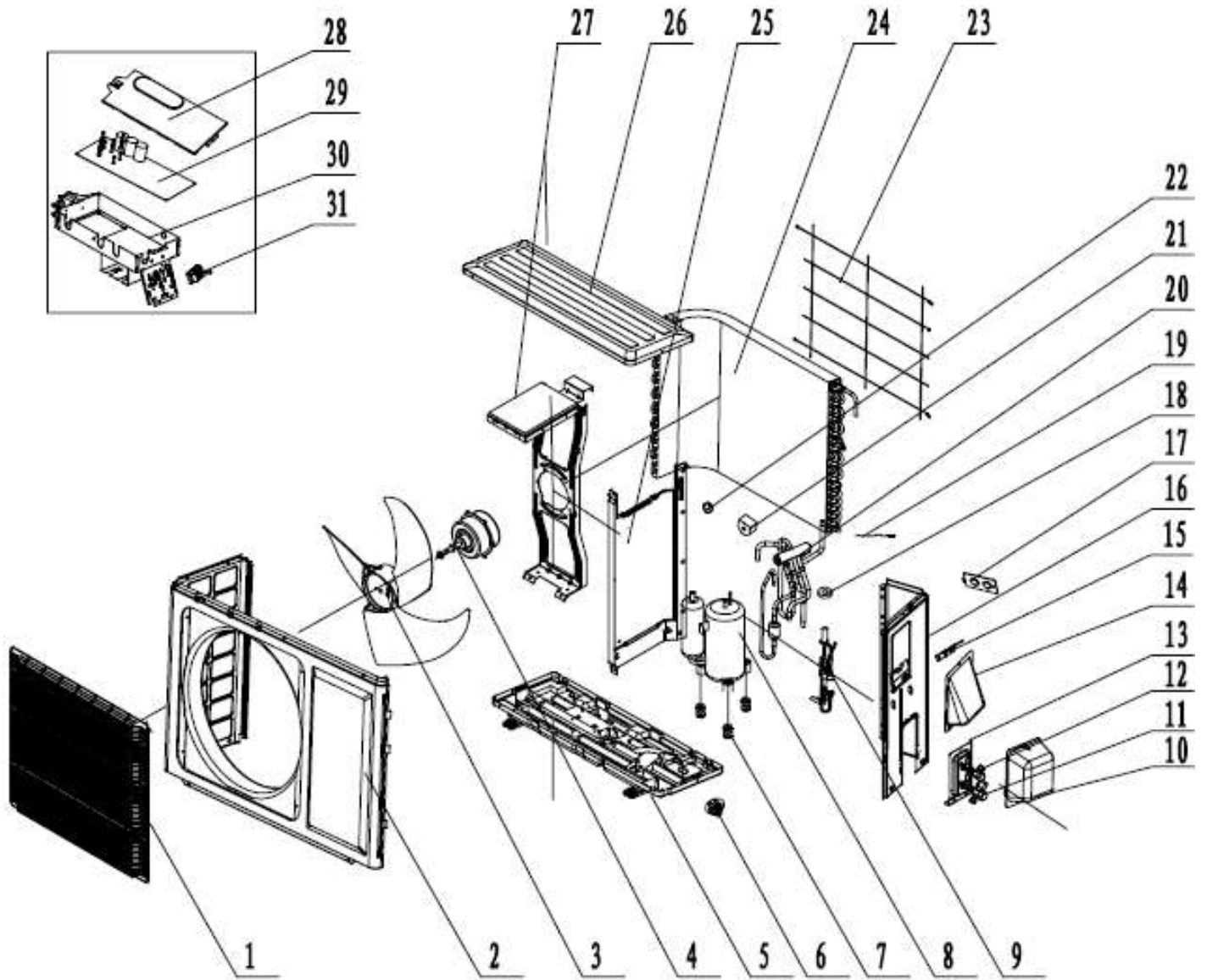

VIR09HP115V1BO
9,000 BTUH 115v Outdoor Unit
Product Code: GWH09QC-A3DNA1D/O

NO.	Part Code	Part Description	Qty
1	01473012	Front Grille	1
2	0153304901	Front Panel Assy	1
3	10333004	Axial Flow Fan	1
4	1501308507	Fan Motor	1
5	01203881P	Chassis Sub-Assy	1
6	06123401	Drainage Connector	1
Not Shown	76510010	Basepan Heater	1
7	76710302	Compressor Grommet	3
Not Shown	76510009	Compressor Crankcase Heater	1
8	00103862	Compressor and Fittings	1
Not Shown	03700200294	Capillary Sub-Assy	1
Not Shown	07135228	Electronic Expansion Valve	!
9	03002600039	Electronic Expansion Valve Assy	1
Not Shown	4300876704	Electronic Expansion Valve Solenoid Coil	1
10	2012300101	Valve Cover	1
11	07130239	1/4-in Liquid Line Valve	1
12	07100005	3/8-in Gas/Suction Valve	1
13	01713041	Valve Support	1
14	02123014P	Cable Cross Plate 2	1
15	02123013P	Cable Cross Plate 1	1
16	013030713	Right Side Plate Assy	1
17	01413069	Pass Wire Cover	1
18	4300876704	Electric Expansion Valve Fitting	1
19	39000310	Temperature Sensor Assy **	1
Not Shown	430004022	4-Way Valve	1
20	03015200082	4-Way Valve Assy	1
21	4300040021	4-Way Valve Solenoid Coil	1
22	00180030	Compressor Overload Protector(External)	1
Not Shown	00183032	Compressor Overload Protector(External)	1
Not Shown	00183031	Compressor Overload Protector(External)	1
23	01473057	Rear Grille	1
24	01100200189	Condenser Coil Assy	1
25	01233034	Clapboard Sub-Assy	1
26	0125344311P	Top Cover Plate	1
28	0260309601	Electric Box Cover Sub-Assy	1
29	30138000523	Main Control Board	1
30	10000100182	Electric Control Box Assy	1
31	42010255	Terminal Board	1

** Temperature Sensor Assembly contains Discharge, Condenser Coil and Ambient sensors.

VIR09HP230V1BH

9,000 BTUH 208/230v Indoor Unit

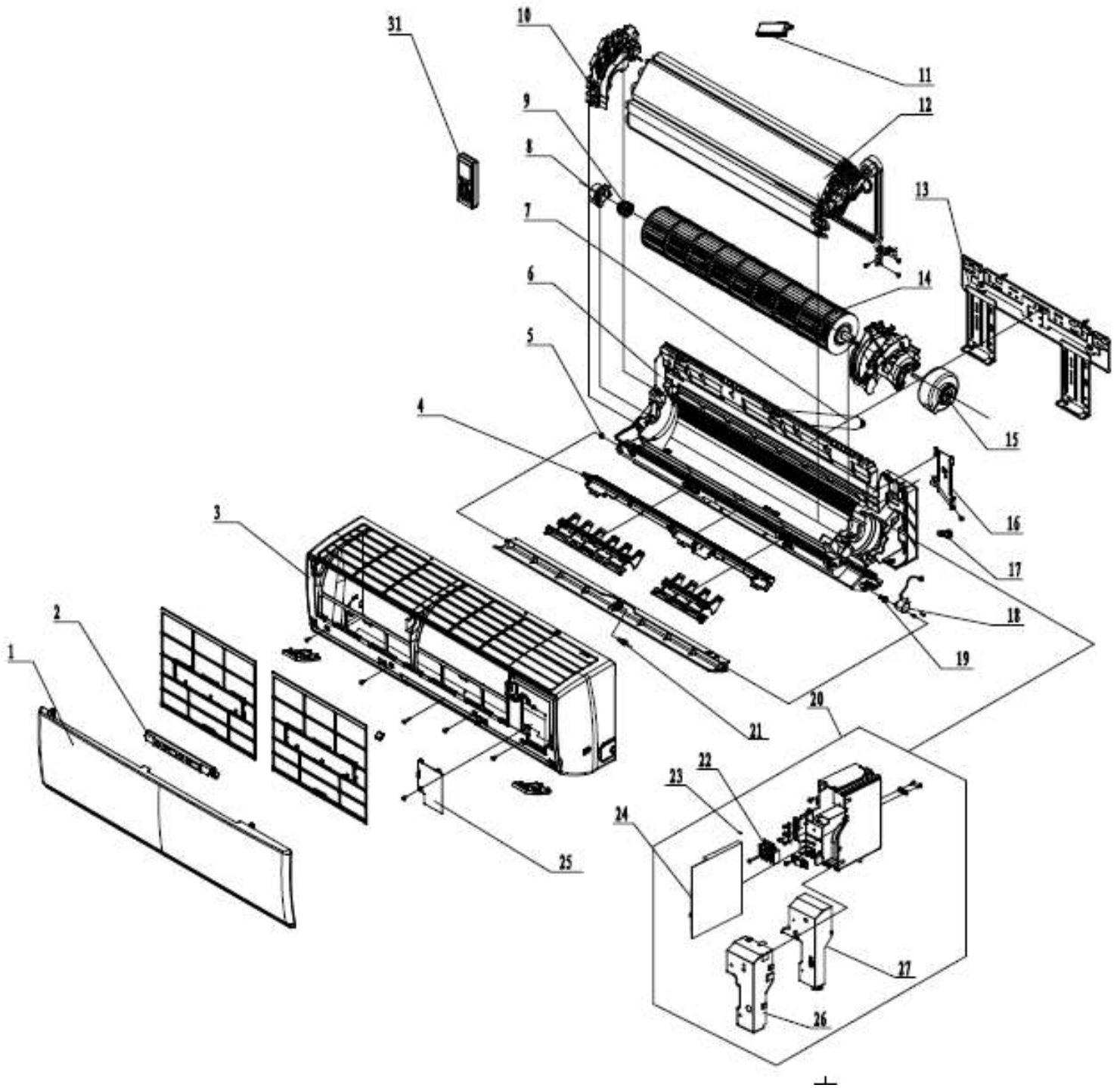

VIR09HP230V1BH
9,000 BTUH 208/230v Indoor Unit
Product Code: GWH09QC-D3DNB2D/I

NO.	Part Code	Part Description	Qty
1	20000300018S	Front Panel B2	1
Not Shown	11122468	Air Filter	2
2	30565260	Display Board	1
3	00000200045	Front Case Assy	1
4	26112436	Helicoid Tongue	1
5	10512037	Left Axial Bushing	1
6	00000100093	Rear Case Assy	1
7	05230014	Drainage Hose	1
8	26152022	Bearing Ring	1
9	7651205102	Bearing Ring O-Gasket Sub-Assy	1
10	24212174	Evaporator Support	1
12	01002000030	Evaporator Coil Assy	1
13	01252484	Wall Mounting Bracket	1
14	10352056	Cross Flow Fan	1
15	1501246601	Fan Motor	1
16	2611216401	Condensate Pipe Clamp	1
17	76712012	Condensate Drain Plug	1
18	1521210710	Stepper Motor	1
19	73012005	Crank	1
20	100002002094	Electric Control Box Assy	1
21	10542036	Axial Bushing	1
22	42011233	Terminal Board	1
23	4202021909	Configuration Jumper	1
24	30138001018	Main Control Board	1
25	0140206501	Electric Box Cover Sub-Assy	1
26	01592150	Electric Box Shield Cover	1
27	2011220701	Electric Box Cover	1
Not Shown	3900031302	Ambient Temperature Sensor	1
Not Shown	3900031302	Indoor Coil Temperature Sensor	1
31	30510475	Remote Controller (YAN1F1F)	1
Not Shown	26150009	Remote Controller Holder/Cradle	1

VIR09HP230V1BO

9,000 BTUH 208/230v Outdoor Unit

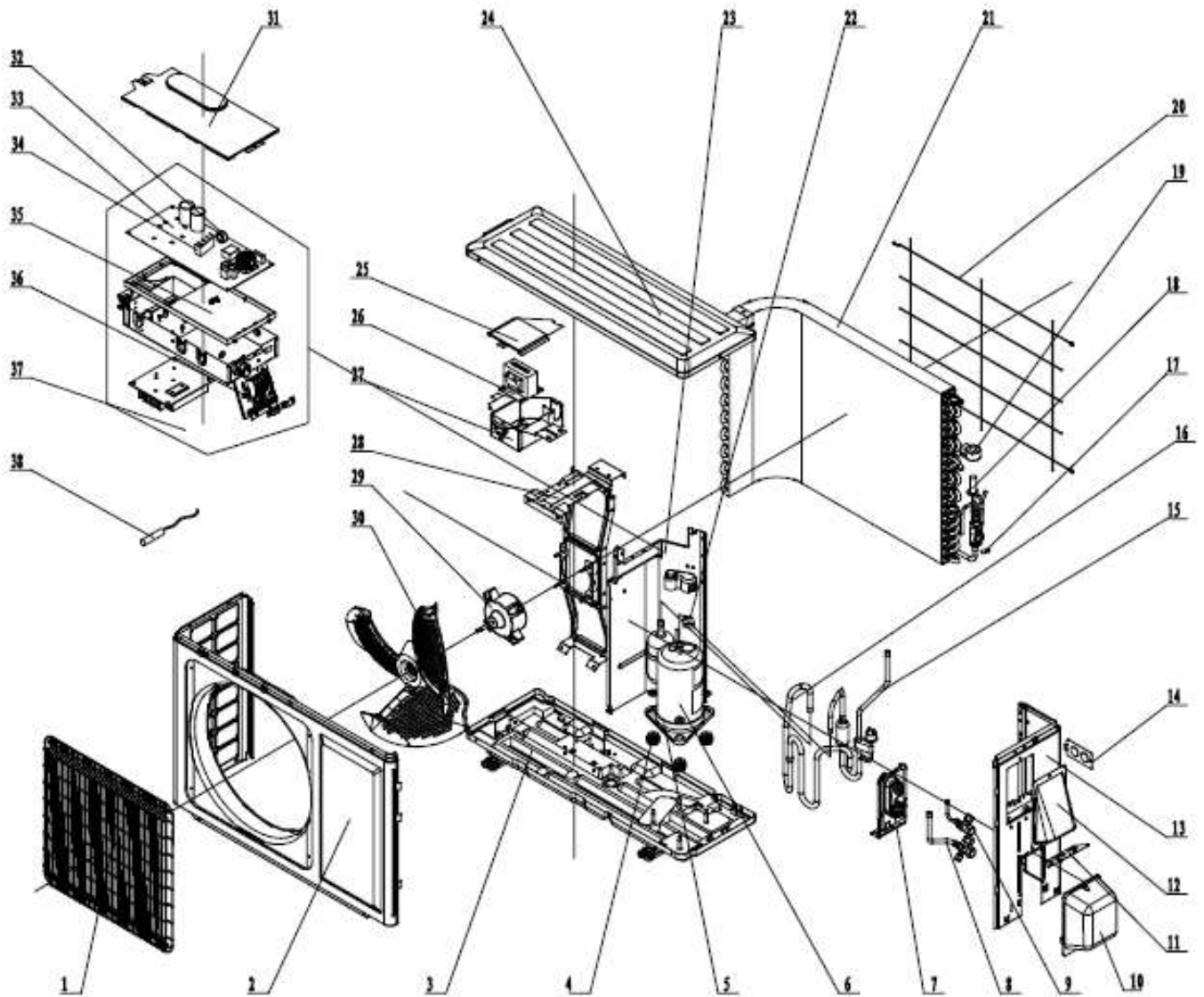

VIR09HP230V1BO
9,000 BTUH 208/230v Outdoor Unit
Product Code: GWH09QC-D3DNA1D/O

NO.	Part Code	Part Description	Qty
1	01473012	Front Grille	1
2	0153304901	Front Panel Assy	1
3	01700000053P	Chassis Sub-Assy	1
Not Shown	76513004	Basepan Heater	1
4	76713027	Compressor Grommet	3
5	76513004	Compressor Crankcase Heater	1
6	00103892	Compressor and Fittings	1
Not Shown	03133693	Capillary Sub-Assy	1
7	01713041	Valve Support	1
8	07100005	3/8-in Gas/Suction Valve	1
9	07100003	1/4-in Liquid Line Valve	1
10	2012300101	Valve Cover	1
11	02123013P	Cable Cross Plate 1	1
12	02123014P	Cable Cross Plate 2	1
13	0130306903	Right Side Plate	1
14	01413069	Pass Wire Cover	1
15	03733709	Discharge Tube Sub-Assy	1
16	03833444	Inhalation/Suction Tube Sub-Assy	1
17	05212423	Temp Sensor Sleeve	1
Not Shown	07130369	Electronic Expansion Valve	1
18	07133769	Electronic Expansion Valve Assy	1
19	4300876705	Electronic Expansion Valve Solenoid Coil	1
20	01473057	Rear Grille	1
Not Shown	430004032	4-Way Valve	1
Not Shown	4300040047	4-Way Valve Solenoid Coil	1
21	01163565	Condenser Coil Assy	1
22	00183111	Compressor Overload Protector(External)	1
Not Shown	00183114	Compressor Overload Protector(External)	1
23	01233034	Clapboard Sub-Assy	1
24	0125344311P	Top Cover Plate	1
25	01413029	Reactor Box Cover	1
26	43130185	Reactor	1
27	01413092	Reactor Box	1
29	1501308507	Fan Motor	1
30	10333004	Axial Flow Fan	1
31	0260309601	Electric Box Cover Sub-Assy	1
32	49010104	Magnetic Ring	1
33	30138000521	Main Control Board	1
34	49013026	Heat Sink/Radiator	1
35	20113005	Electric Control Box 1	1
36	71010003	Wire Clamp	1
37	10000100188	Electric Control Box Assy	1
38	39000310	Temperature Sensor Assy **	1

** Temperature Sensor Assembly contains Discharge, Condenser Coil and Ambient sensors.

VIR12HP115V1BH

12,000 BTUH 115v Indoor Unit

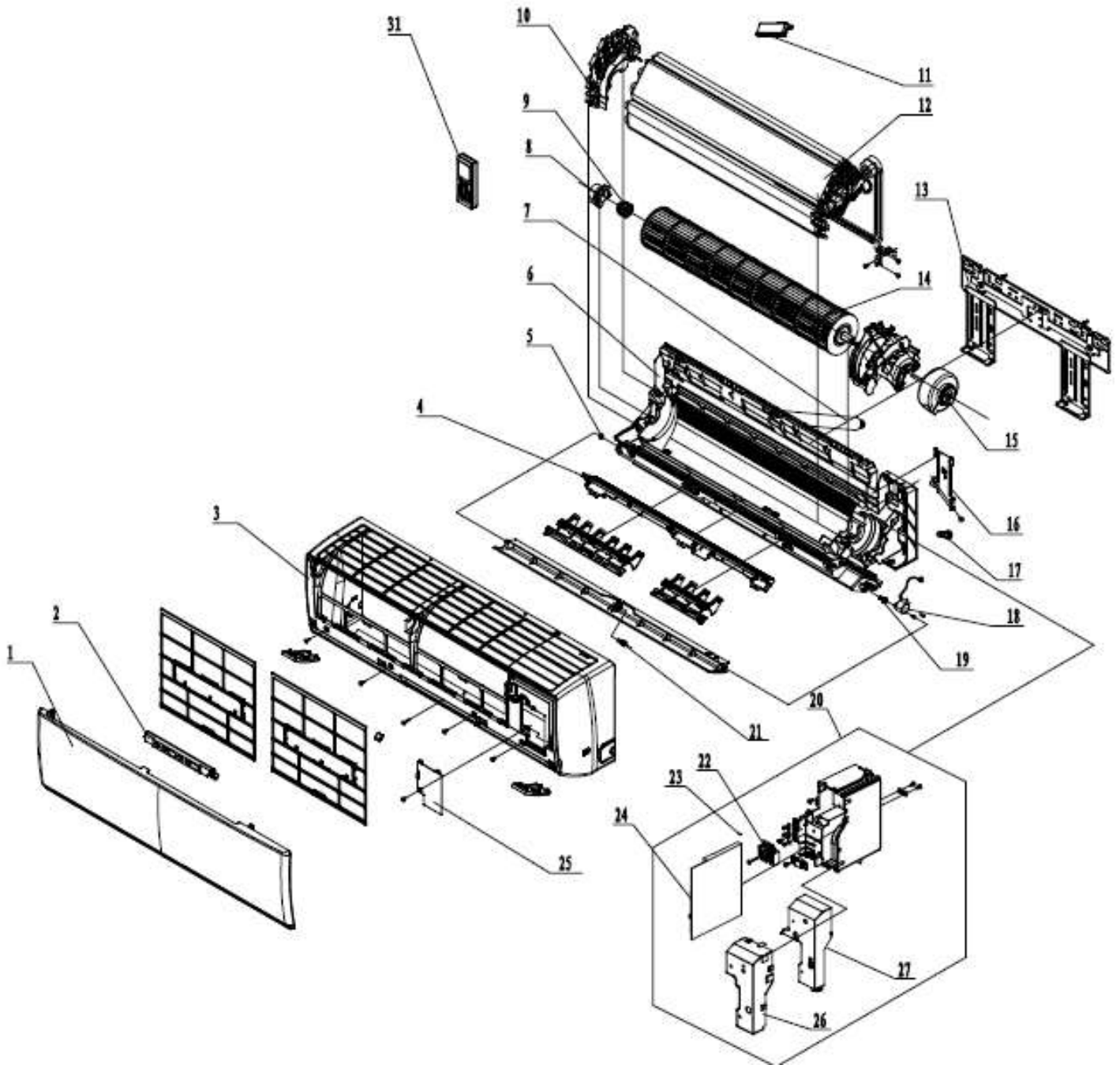

VIR12HP115V1BH
12,000 BTUH 115v Indoor Unit
Product Code: GWH12QC-A3DNB2D/I

NO.	Part Code	Part Description	Qty
1	20000300018S	Front Panel B2	1
Not Shown	11122468	Air Filter	2
2	30565260	Display Board	1
3	00000200045	Front Case Assy	1
4	26112436	Helicoid Tongue	1
5	10512037	Left Axial Bushing	1
6	00000100093	Rear Case Assy	1
7	05230014	Drainage Hose	1
8	26152022	Bearing Ring	1
9	7651205102	Bearing Ring O-Gasket Sub-Assy	1
10	24212174	Evaporator Support	1
12	0100200003001	Evaporator Coil Assy	1
13	01252484	Wall Mounting Bracket	1
14	10352056	Cross Flow Fan	1
15	15012153	Fan Motor	1
16	2611216401	Condensate Pipe Clamp	1
17	76712012	Condensate Drain Plug	1
18	1521210710	Stepper Motor	1
19	73012005	Crank	1
20	100002002078	Electric Control Box Assy	1
21	10542036	Axial Bushing	1
22	42011233	Terminal Board	1
23	4202021920	Configuration Jumper	1
24	30138001018	Main Control Board	1
25	0140206501	Electric Box Cover Sub-Assy	1
26	01592150	Electric Box Shield Cover	1
27	2011220701	Electric Box Cover	1
Not Shown	3900031302	Ambient Temperature Sensor	1
Not Shown	3900031302	Indoor Coil Temperature Sensor	1
31	30510475	Remote Controller (YAN1F1F)	1
Not Shown	26150009	Remote Controller Holder/Cradle	1

VIR12HP115V1BO

12,000 BTUH 115v Outdoor Unit

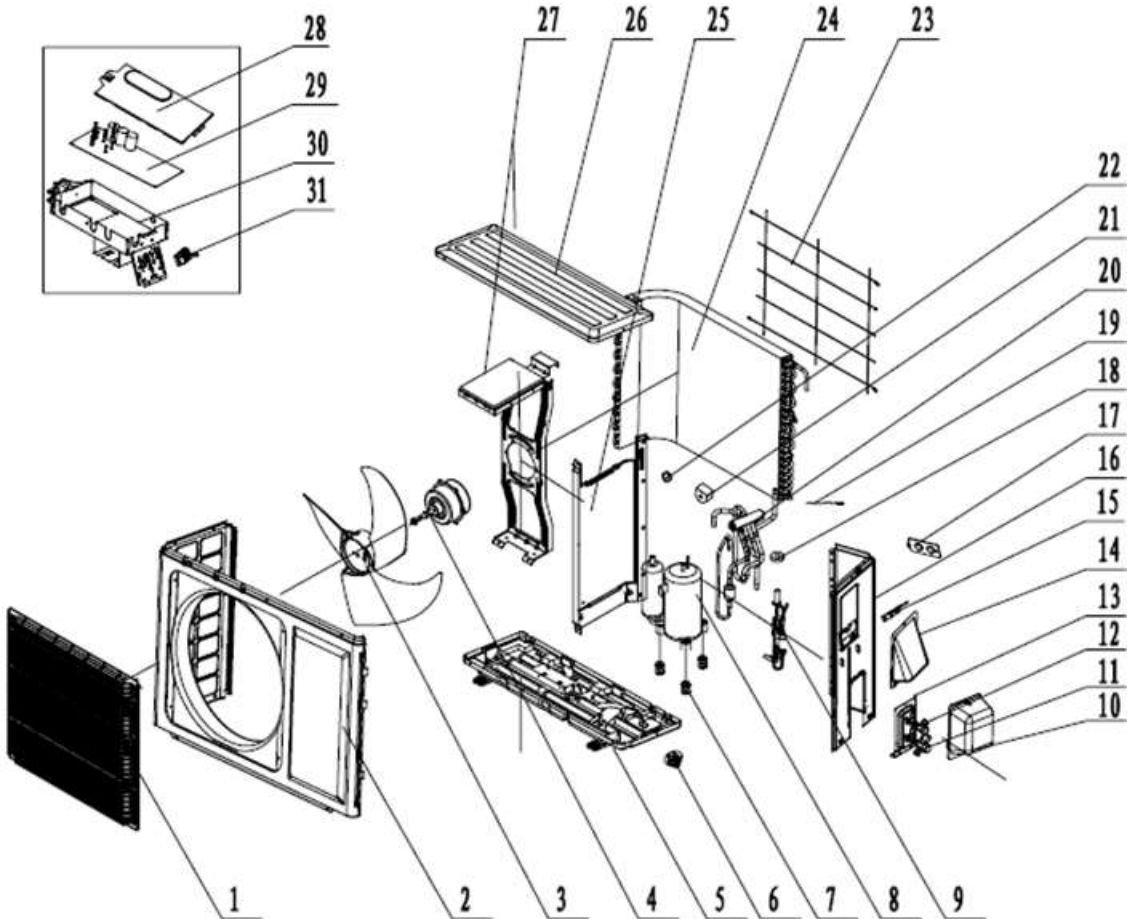

VIR12HP115V1BO
12,000 BTUH 115v Outdoor Unit
Product Code: GWH12QC-A3DNA1D/O

NO.	Part Code	Part Description	Qty
1	01473012	Front Grille	1
2	0153501604	Front Panel Assy	1
3	10333004	Axial Flow Fan	1
4	1501308507	Fan Motor	1
5	76510010	Basepan Heater	1
6	01203881P	Chassis Sub-Assy	1
7	06123401	Drainage Connector	1
8	76510009	Compressor Crankcase Heater	1
9	00103862	Compressor and Fittings	1
10	76710302	Compressor Grommet	3
Not Shown	03143102	Capillary Sub-Assy	1
11	4300040021	4-Way Valve Solenoid Coil	1
12	01713041	Valve Support	1
13	07100006	1/2-in Gas/Suction Valve	1
14	07130239	1/4-in Liquid Line Valve	1
15	22243010	Valve Cover	1
16	02123013P	Cable Cross Plate 1	1
17	02123014P	Cable Cross Plate 2	1
18	00013000001002	Right Side Plate	1
19	03073339	4-Way Valve Assy	1
20	430004022	4-Way Valve	1
Not Shown	07135228	Electronic Expansion Valve	1
21	030026000072	Electronic Expansion Valve Assy	1
22	4300876704	Electronic Expansion Valve Solenoid Coil	1
23	01475014	Rear Grille	1
24	011002000138	Condenser Coil Assy	1
25	00180030	Compressor Overload Protector(External)	1
Not Shown	00183032	Compressor Overload Protector(External)	1
Not Shown	00183031	Compressor Overload Protector(External)	1
26	01233090	Clapboard Sub-Assy	1
27	0125344311P	Top Cover Plate	1
29	0260309601	Electric Box Cover Sub-Assy	1
30	30138000545	Main Control Board	1
31	49010065	Heat Sink/Radiator	1
32	20113005	Electric Control Box 1	1
33	42010255	Terminal Board	1
34	01403767	Capacitor Box Sub-Assy	1
35	71010003	Wire Clamp	1
36	10000100184	Electric Control Box Assy	1
37	39000310	Temperature Sensor Assy **	1

** Temperature Sensor Assembly contains Discharge, Condenser Coil and Ambient sensors.

VIR12HP230V1BH

12,000 BTUH 208/230v Indoor Unit

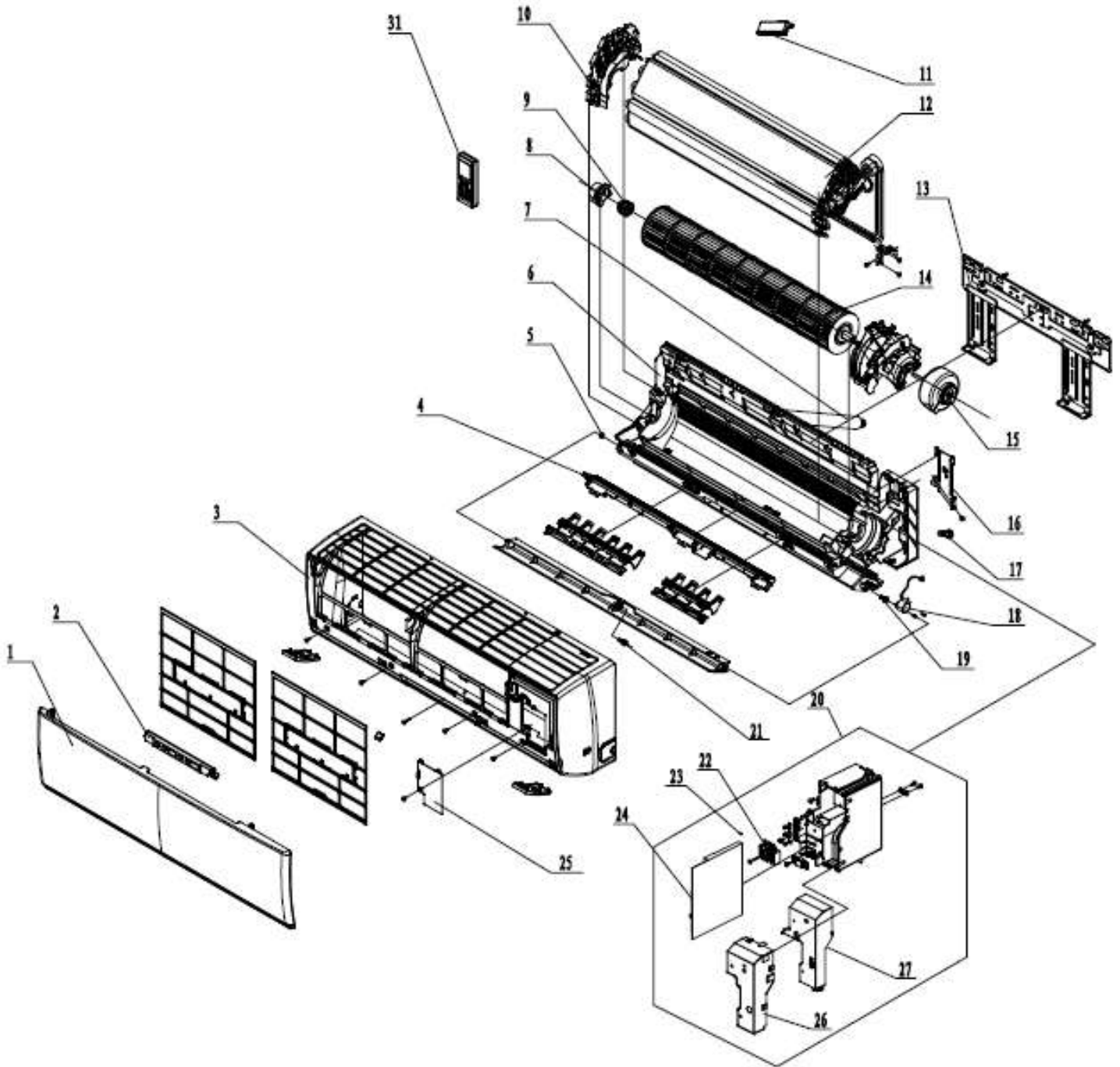

VIR12HP230V1BH
12,000 BTUH 208/230v Indoor Unit
Product Code: GWH12QC-D3DNB2D/I

NO.	Part Code	Part Description	Qty
1	20000300018S	Front Panel B2	1
Not Shown	11122468	Air Filter	2
2	30565260	Display Board	1
3	00000200045	Front Case Assy	1
4	26112436	Helicoid Tongue	1
5	10512037	Left Axial Bushing	1
6	00000100093	Rear Case Assy	1
7	05230014	Drainage Hose	1
8	26152022	Bearing Ring	1
9	7651205102	Bearing Ring O-Gasket Sub-Assy	1
10	24212174	Evaporator Support	1
12	0100200003001	Evaporator Coil Assy	1
13	01252484	Wall Mounting Bracket	1
14	10352056	Cross Flow Fan	1
15	1501246601	Fan Motor	1
16	2611216401	Condensate Pipe Clamp	1
17	76712012	Condensate Drain Plug	1
18	1521210710	Stepper Motor	1
19	73012005	Crank	1
20	100002002078	Electric Control Box Assy	1
21	10542036	Axial Bushing	1
22	42011233	Terminal Board	1
23	4202021920	Configuration Jumper	1
24	30138001018	Main Control Board	1
25	0140206501	Electric Box Cover Sub-Assy	1
26	01592150	Electric Box Shield Cover	1
27	2011220701	Electric Box Cover	1
Not Shown	3900031302	Ambient Temperature Sensor	1
Not Shown	3900031302	Indoor Coil Temperature Sensor	1
31	30510475	Remote Controller (YAN1F1F)	1
Not Shown	26150009	Remote Controller Holder/Cradle	1

VIR12HP230V1BO

12,000 BTUH 208/230v Outdoor Unit

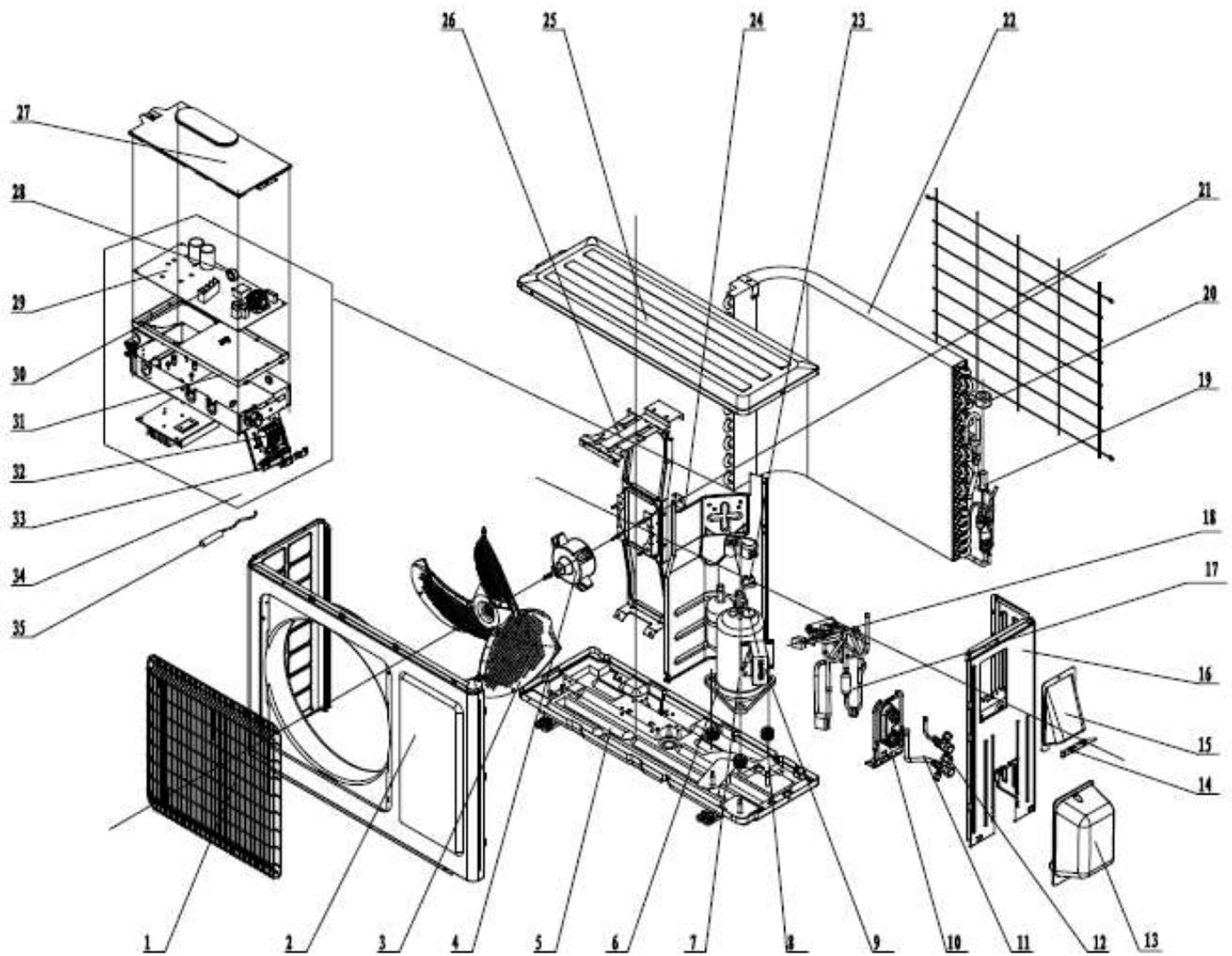

VIR12HP230V1BO
12,000 BTUH 208/230v Outdoor Unit
Product Code: GWH12QC-D3DNA1D/O

NO.	Part Code	Part Description	Qty
1	01473012	Front Grille	1
2	0153501604	Front Panel Assy	1
3	10333004	Axial Flow Fan	1
4	1501308505	Fan Motor	1
Not Shown	76513004	Basepan Heater	1
5	01700000053P	Chassis Sub-Assy	1
6	76513004	Compressor Crankcase Heater	1
7	00103892	Compressor and Fittings	1
8	76713027	Compressor Grommet	3
9	43130185	Reactor	1
10	01713041	Valve Support	1
11	07100006	1/2-in Gas/Suction Valve	1
12	07100003	1/4-in Liquid Line Valve	1
13	22243010	Valve Cover	1
14	02123013P	Cable Cross Plate 1	1
15	02123014P	Cable Cross Plate 2	1
16	00013000001002	Right Side Plate	1
Not Shown	430004032	4-Way Valve	1
17	03015200098	4-Way Valve Assy	1
18	4300040047	4-Way Valve Solenoid Coil	1
Not Shown	07130369	Electronic Expansion Valve	1
19	0030026000070	Electronic Expansion Valve Assy	1
20	4300876708	Electronic Expansion Valve Solenoid Coil	1
21	01475014	Rear Grille	1
22	011002000137	Condenser Coil Assy	1
23	00183111	Compressor Overload Protector(External)	1
Not Shown	00183114	Compressor Overload Protector(External)	1
24	01233090	Clapboard Sub-Assy	1
25	0125344311P	Top Cover Plate	1
27	0260309601	Electric Box Cover Sub-Assy	1
28	49010104	Magnetic Ring	1
29	30138000519	Main Control Board	1
30	49013026	Heat Sink/Radiator	1
31	20113005	Electric Control Box 1	1
32	42010313	Terminal Board	1
33	71010003	Wire Clamp	2
34	10000100190	Electric Control Box Assy	1
35	39000310	Temperature Sensor Assy **	1

** Temperature Sensor Assembly contains Discharge, Condenser Coil and Ambient sensors.

VIR18HP230V1BH

18,000 BTUH 208/230v Indoor Unit

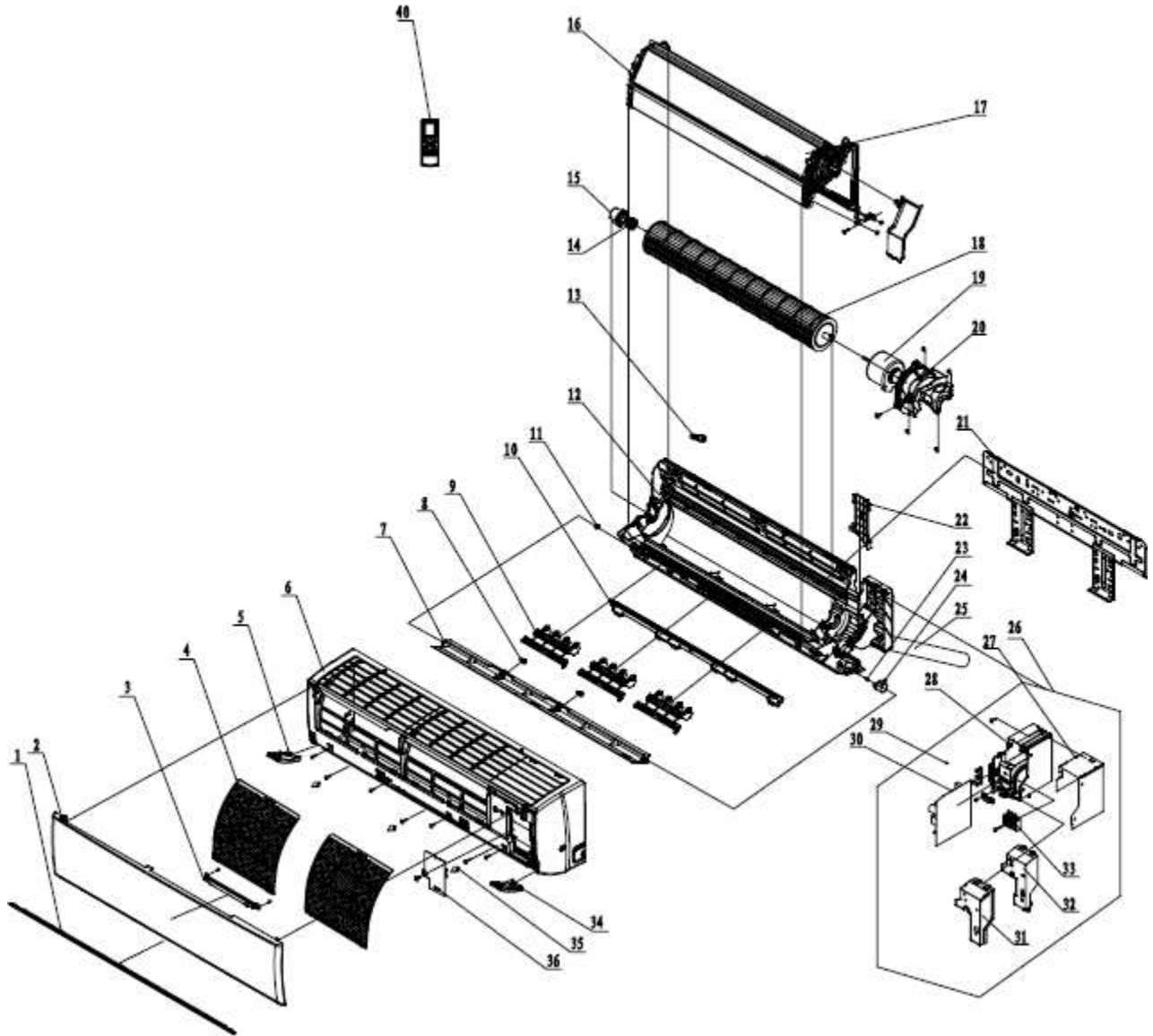

VIR18HP230V1BH
18,000 BTUH 208/230v Indoor Unit
Product Code: GWH18QD-D3DNB2G/I

NO.	Part Code	Part Description	Qty
1	none	Decorative Strip	0
2	20000300023S	Front Panel	1
3	30565260	Display Board	1
4	1112208904	Air Filter	2
5	20192662	Decorative Board (Right)	1
6	00000200042	Front Case Assy	1
7	1051276501	Guide Louver	1
8	10542036	Axial Bushing	2
9	10512732	Air Louver (Manual)	3
10	26112512	Helicoid Tongue	1
11	10512037	Left Axial Bushing	1
12	22202571	Rear Case Assy	1
13	76712012	Condensate Drain Plug	1
14	7651205102	Bearing Ring O-Gasket Sub-Assy	1
15	26152025	Bearing Ring	1
16	24212177	Evaporator Support	1
17	01100100085	Evaporator Coil Assy	1
18	10352060	Cross Flow Fan	1
19	15012136	Fan Motor	1
20	26112511	Motor Press Plate	1
21	01362026	Wall Mounting Bracket	1
22	2611218801	Condensate Pipe Clamp	1
23	73012005	Crank	1
24	1521240212	Stepper Motor	1
25	05230014	Drainage Hose	1
26	10000203680	Electric Control Box Assy	1
27	01592139	Lower Electric Box Shield	1
28	2011221102	Electric Box	1
29	4202021924	Configuration Jumper	1
30	30138001018	Main Control Board	1
31	01592176	Electric Box Shield Cover	1
32	2011220901	Electric Box Cover	1
33	4201123303	Terminal Board	1
35	2425201726	Screw Cover	3
36	2011221001	Electric Box Cover 2	1
Not Shown	3900031302	Ambient Temperature Sensor	1
Not Shown	3900031302	Indoor Coil Temperature Sensor	1
40	30510475	Remote Controller (YAN1F1F)	1
Not Shown	26150009	Remote Controller Holder/Cradle	1

VIR18HP230V1BO

18,000 BTUH 208/230v Outdoor Unit

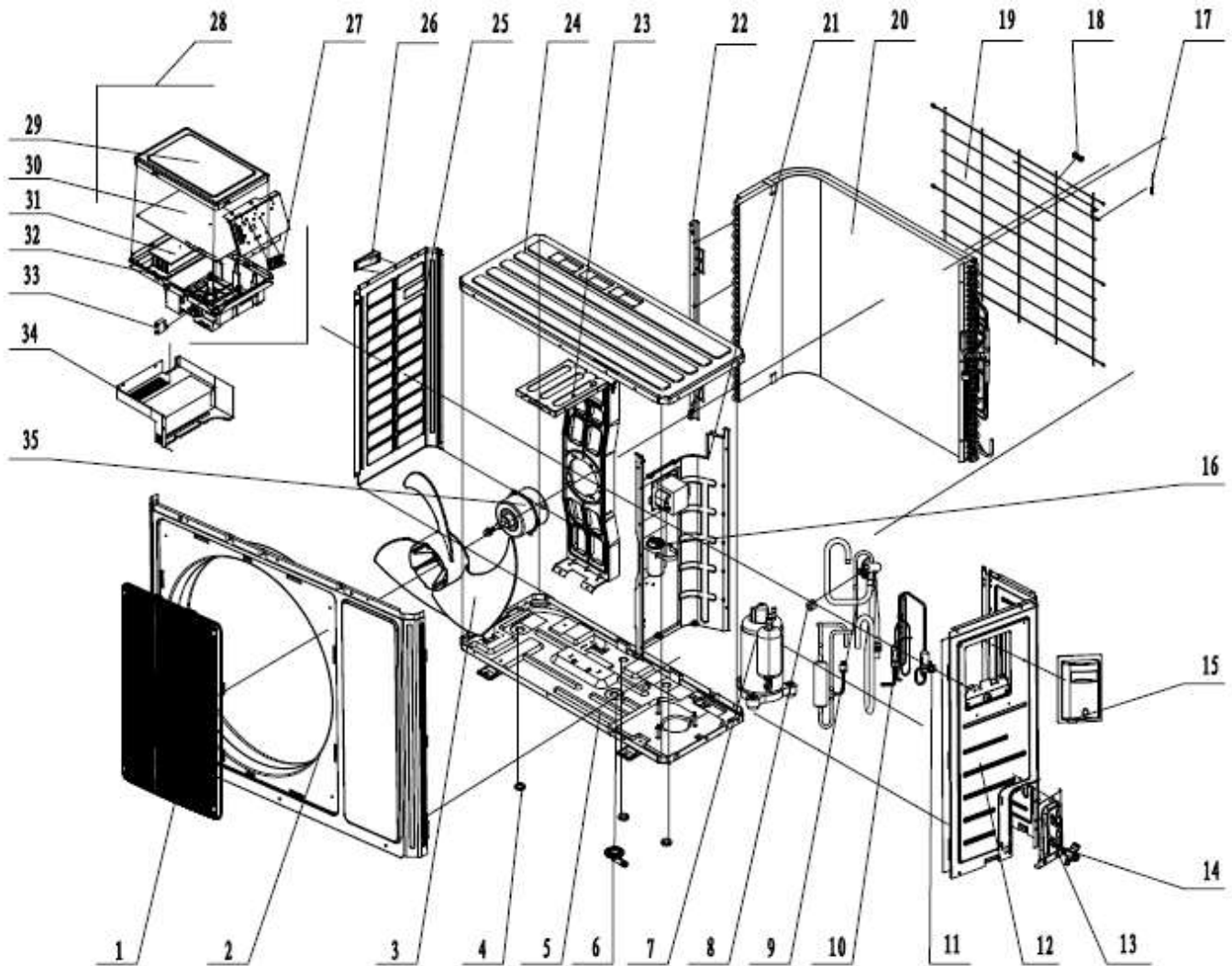

VIR18HP230V1BO
18,000 BTUH 208/230v Outdoor Unit
Product Code: GWH18QD-D3DNA1G/O

NO.	Part Code	Part Description	Qty
1	01473049	Front Grille	1
2	0000030002401	Front Panel Assy	1
3	10335008	Axial Flow Fan	1
5	01700000161P	Chassis Sub-Assy	1
Not Shown	7651000411	Basepan Heater	1
6	06123401	Drainage Connector	1
7	00105249G	Compressor and Fittings	1
Not Shown	00180030	Compressor Overload Protector(External)	1
Not Shown	00183051	Compressor Overload Protector(External)	1
Not Shown	00183032	Compressor Overload Protector(External)	1
Not Shown	07130369	Electronic Expansion Valve	1
Not Shown	4300876705	Electronic Expansion Valve Solenoid Coil	1
8	430004032	4-Way Valve	1
9	03073411	4-Way Valve Assy	1
Not Shown	4300040078	4-Way Valve Solenoid Coil	1
10	03015737	Capillary Sub-Assy	1
11	07130239	1/4-in Liquid Line Valve	1
12	0130329208	Right Side Plate	1
13	01705046P	Valve Support Sub-Assy	1
14	07133844	1/2-in Gas/Suction Valve	1
15	26233053	Handle Assy	1
17	3900030902	Temperature Sensor Assy**	1
19	01475020	Rear Grille	1
20	01103000090	Condenser Coil Assy	1
21	01235081	Clapboard Sub-Assy	1
22	01795031	Condenser Support Plate	1
23	01705067	Motor Support Sub-Assy	1
24	000051000017	Top Cover	1
25	01305093P	Left Side Plate	1
27	42010255	Terminal Board	1
28	10000100632	Electric Control Box Assy	1
29	20125002	Electric Box Cover	1
30	30138000873	Main Control Board	1
31	49010252	Heat Sink/Radiator	1
32	20115003	Electric Box	1
35	1501506402	Fan Motor	1

** Temperature Sensor Assembly contains Discharge, Condenser Coil and Ambient sensors.

VIR24HP230V1BH

24,000 BTUH 208/230v Indoor Unit

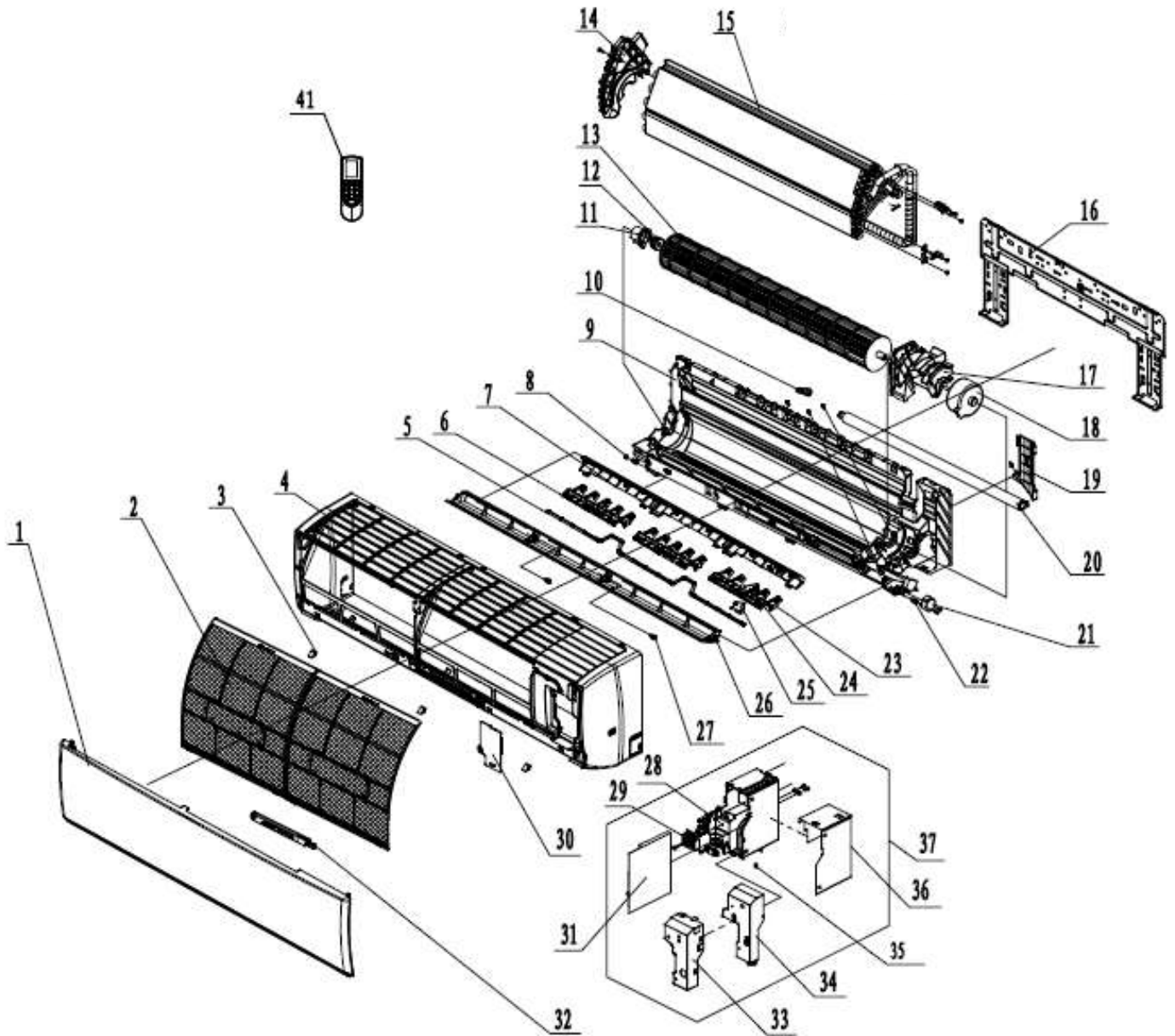

VIR24HP230V1BH
24,000 BTUH 208/230v Indoor Unit
Product Code: GWH24QE-D3DNB2D/I

NO.	Part Code	Part Description	Qty
1	20000300016S	Front Panel	1
2	11012007	Air Filter	2
3	2425245301	Screw Cover	3
4	00000200057	Front Case Assy	1
7	26112382	Helicoid Tongue Sub-Assy	1
8	10512037	Left Axial Bushing	1
9	22202570	Rear Case Assy	1
10	76712012	Condensate Drain Plug	1
11	26152025	Bearing Ring	1
12	7651205102	Bearing Ring O-Gasket Sub-Assy	1
13	10352057	Cross Flow Fan	1
14	24212178	Evaporator Support	1
15	01100100029	Evaporator Coil Assy	1
16	01252229	Wall Mounting Bracket	1
17	26112515	Motor Press Plate	1
18	15012136	Fan Motor	1
19	26112514	Condensate Pipe Clamp	1
20	0523001405	Drainage Hose	1
21	1521240212	Stepper Motor	1
22	73012005	Crank	1
24	10512737	Air Louver(Manual)	3
26	1051232001	Guide Louver	1
27	10542036	Axial Bushing	2
28	2011221102	Electric Control Box	1
29	42011233	Terminal Board	1
30	2011221001	Electric Box Cover 2	1
31	30138001018	Main Control Board	1
32	30565260	Display Board	1
33	01592176	Electric Box Shield Cover	1
34	2011220901	Electric Box Cover	1
35	4202021926	Configuration Jumper	1
36	01592139	Lower Electric Box Shield	1
37	10000203513	Electric Control Box Assy	1
40	3900031302	Ambient Temperature Sensor	1
Not Shown	3900031302	Indoor Coil Temperature Sensor	1
41	30510475	Remote Controller (YAN1F1F)	1
Not Shown	26150009	Remote Controller Holder/Cradle	1

VIR24HP230V1BO

24,000 BTUH 208/230v Outdoor Unit

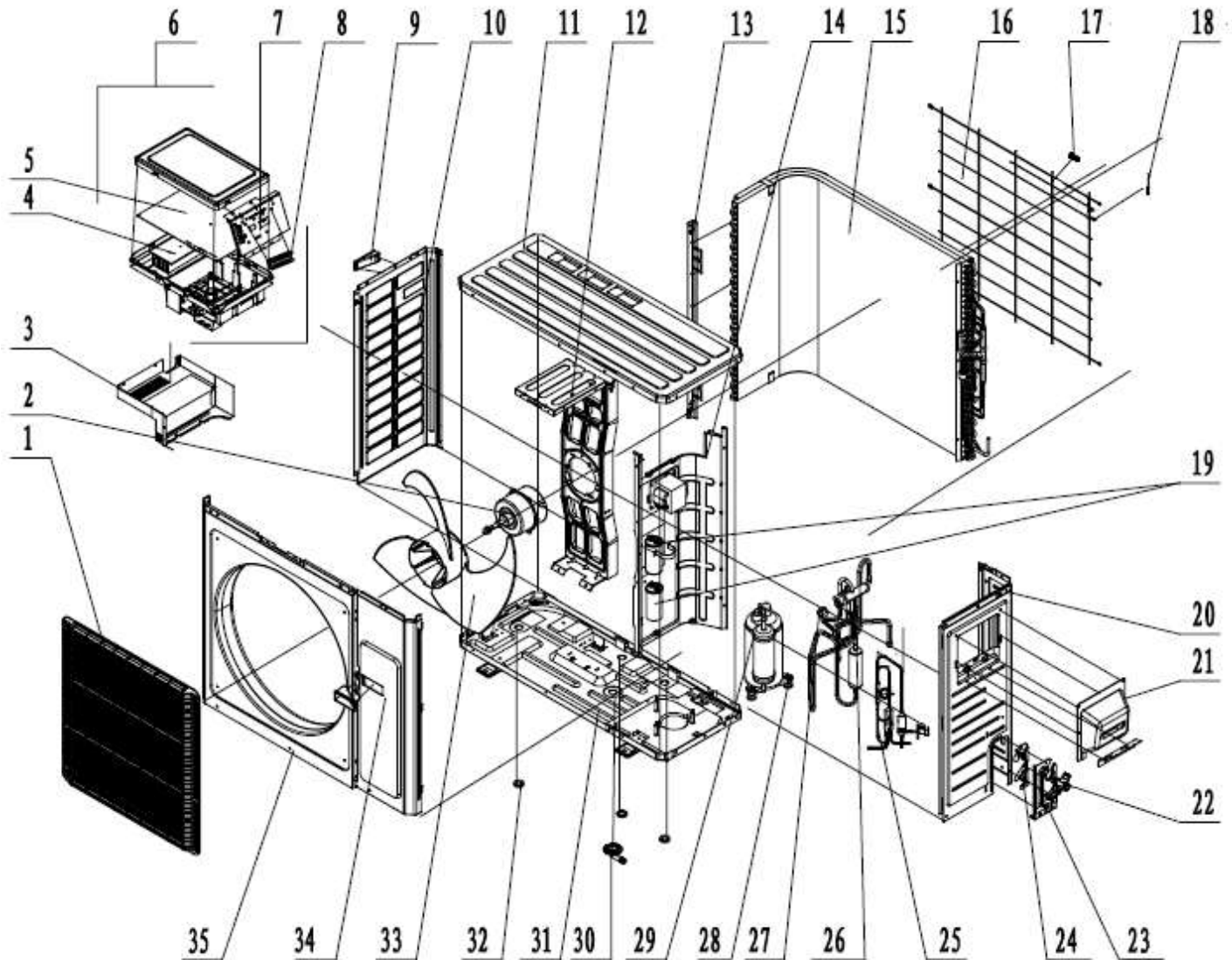

VIR24HP230V1BO
24,000 BTUH 208/230v Outdoor Unit
Product Code: GWH24QE-D3DNA1D/O

NO.	Part Code	Part Description	Qty
1	01473050	Front Grille	1
2	15010400000102	Fan Motor	1
3	01413426	Electric Box (Fireproofing)	1
4	49015215	Heat Sink/Radiator	1
5	30138000504	Main Control Board	1
6	10000100164	Electric Control Box Assy	1
8	42010255	Terminal Board	1
10	01305043P	Left Side Plate	1
11	01255006P	Top Cover	1
12	01701200001	Motor Support Sub-Assy	1
13	01175092	Condenser Support Plate	1
14	01235040	Clapboard Sub-Assy	1
15	01100200162	Condenser Coil Assy	1
16	01475013	Rear Grille	1
17	26115004	Wiring Clamp	1
18	3900030901	Temperature Sensor Assy **	1
20	0130504402P	Right Side Plate	1
21	02115005	Big Handle	1
Not Shown	07130239	1/4-in Liquid Line Valve	1
22	07133157	5/8-in Gas/Suction Valve	1
23	0171501201P	Valve Support Sub-Assy	1
24	01365435P	Baffle (Valve Support)	1
25	03015737	Capillary Sub-Assy	1
Not Shown	4300008201	4-Way Valve	1
26	03015200087	4-Way Valve Assy	1
27	4300040045	4-Way Valve Solenoid Coil	1
28	76713066	Compressor Grommet	3
29	0010505701	Compressor and Fittings	1
Not Shown	00180030	Compressor Overload Protector(External)	1
Not Shown	00183051	Compressor Overload Protector(External)	1
Not Shown	00183032	Compressor Overload Protector(External)	1
Not Shown	07133909	Electronic Expansion Valve	1
Not Shown	4300876704	Electronic Expansion Valve Solenoid Coil	1
30	06123401	Drainage Connector	1
31	0280319604P	Chassis Sub-Assy	1
32	None	Drainage Plug	0
Not Shown	7651000411	Basepan Heater	1
33	10335014	Axial Flow Fan	1
34	01303249P	Front Side Plate Sub-Assy	1
35	0153501405	Front Panel Assy	1

** Temperature Sensor Assembly contains Discharge, Condenser Coil and Ambient sensors.

VIR30HP230V1BH

30,000 BTUH 208/230v Indoor Unit

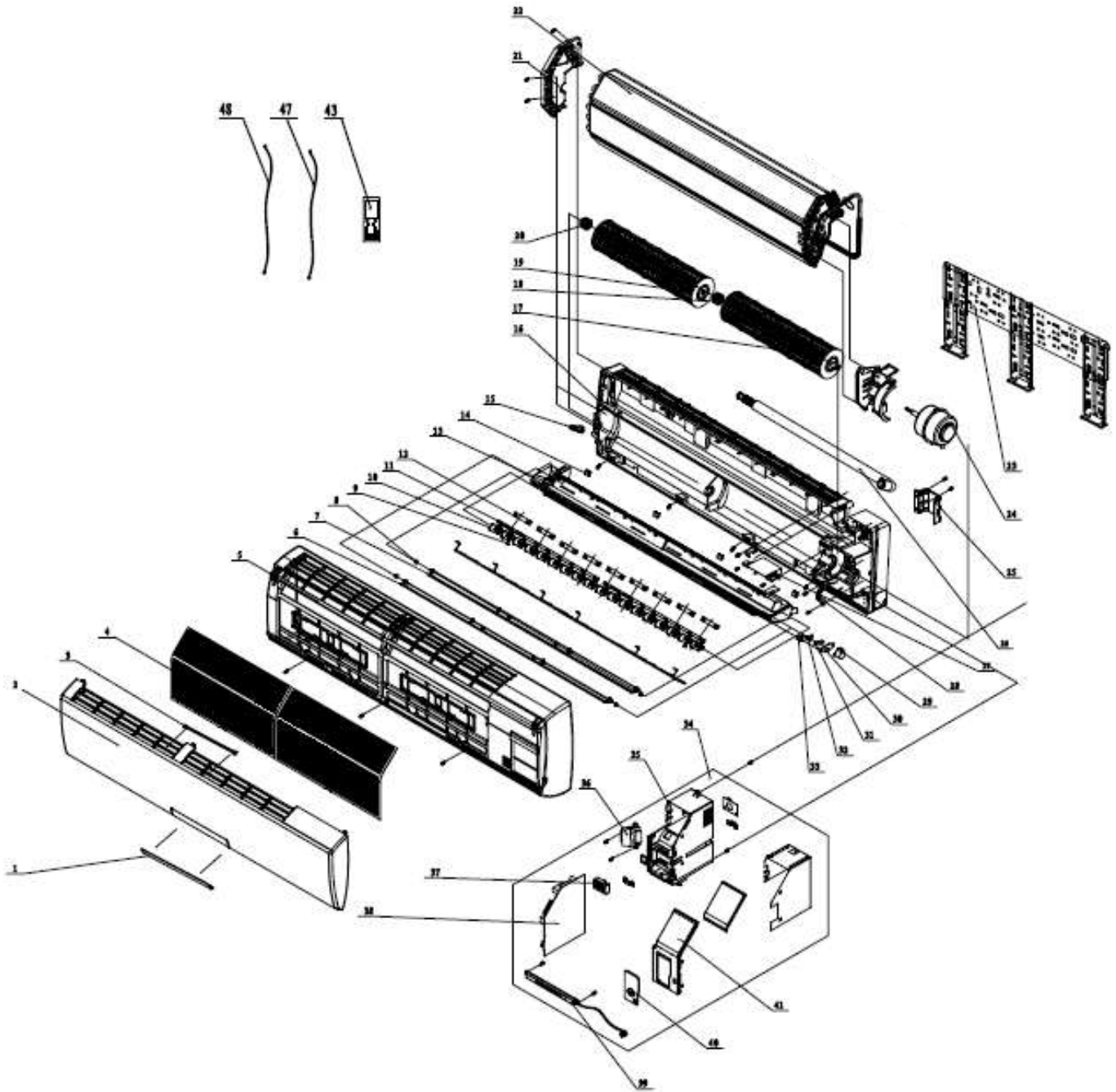

VIR30HP230V1BH
30,000 BTUH 208/230v Indoor Unit
Product Code: GWH30LB-D3DNB2G/I

NO.	Part Code	Part Description	Qty
1	22430024	Receiver Window	1
2	20000300022S	Front Panel	1
3	2421212001	Kick Stand Bar	1
4	11122106	Air Filter	2
5	20900700005	Front Case Sub-Assy	1
6	1051216601	Upper Guide Louver	1
7	1051216701	Lower Guide Louver	1
8	10542704	Axial Bushing	6
9	1051216902	Air Louver 2	2
10	1051216802	Air Louver 1	16
11	10582086	Connecting Rod	2
12	26112158	Louver Clamp	9
13	2018213802	Condensate Water Tray	1
14	2425200506	Screw Cover	4
15	76712012	Condensate Drain Plug	1
16	00000100113	Rear Case Assy	1
17	10352039	Cross Flow Fan 1	1
18	26152028	Bearing Holder Sub-Assy	1
19	10352040	Cross Flow Fan 2	1
20	76512051	Bearing Ring O-Gasket Sub-Assy	1
21	24212041	Left Evaporator Support	1
22	01002000027	Evaporator Coil Assy	1
23	01252398	Wall Mounting Bracket	1
24	1501213401	Fan Motor	1
25	26112071	Condensate Pipe Clamp	1
26	0523001404	Condensate Drainage Hose	1
27	2012212402	Cover Plate	1
28	26112324	Motor Fixed Clip 1	1
29	1521210701	Stepper Motor	1
30	26112070	Press Plate (Crank)	1
31	10582041	Crank-Guide	1
32	10562004	Upper Crank	1
33	10562005	Lower Crank	1
34	10000202639	Electric Control Box Assy	1
35	201022502	Electric Control Box	1
37	42011233	Terminal Board	1
38	30138001017	Main Control Board	1
40	201022523	Electric Box Cover	1
41	2011204404S	Electric Box Cover 1	1
42	30565277	Display Board	1
43	30510475	Remote Controller (YAN1F1F)	1
Not Shown	26150009	Remote Controller Holder/Cradle	1
47	390000592	Indoor Coil Temperature Sensor	1
48	390000453	Ambient Temperature Sensor	1

VIR30HP230V1BO

30,000 BTUH 208/230v Outdoor Unit

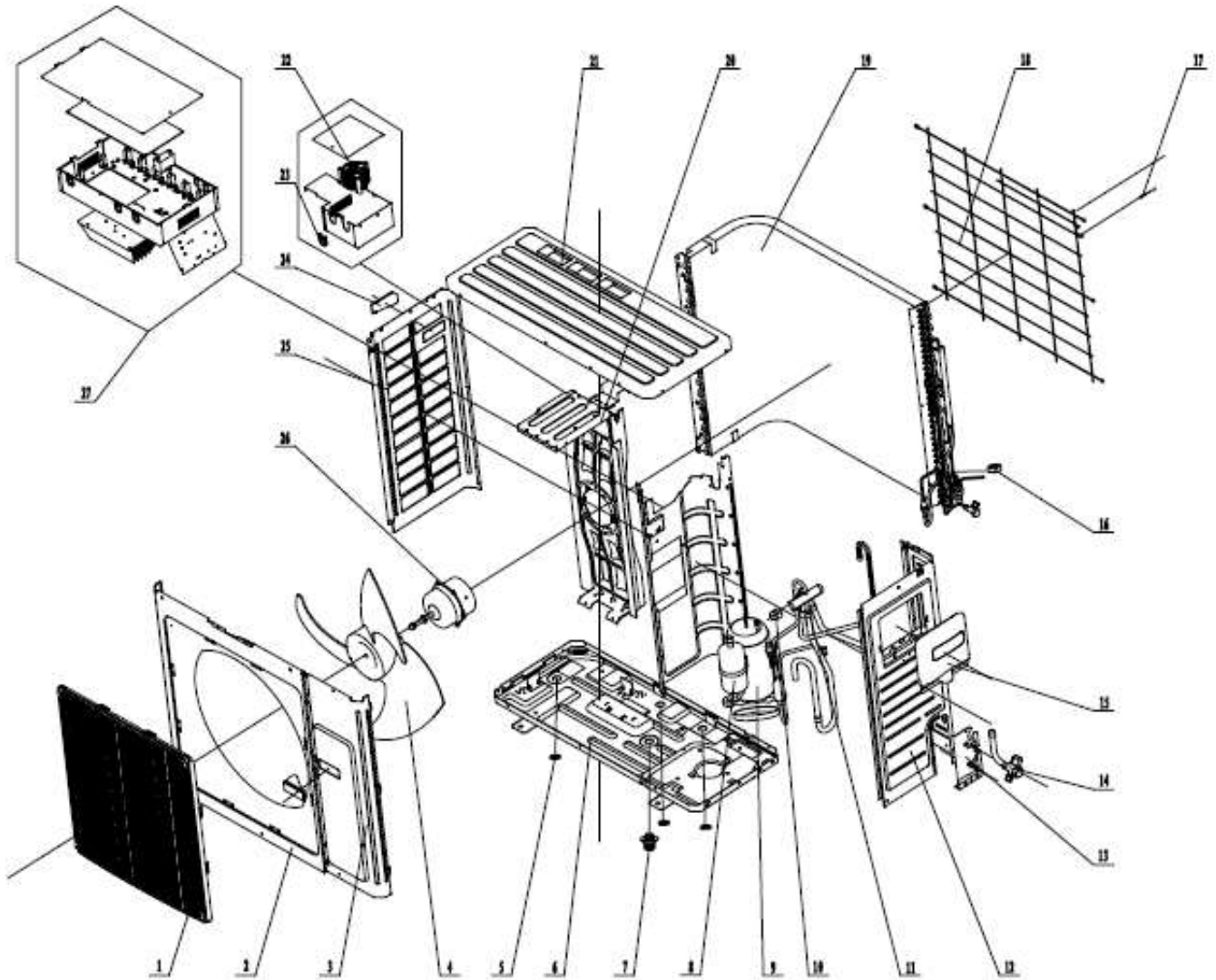

VIR30HP230V1BO
30,000 BTUH 208/230v Outdoor Unit
Product Code: GWH30LB-D3DNA3G/O

NO.	Part Code	Part Description	Qty
1	01473050	Front Grille	1
2	0153501405	Front Panel Assy	1
3	01303249P	Front Side Plate Sub-Assy	1
Not Shown	765100047	Basepan Heater	1
4	10335014	Axial Flow Fan	1
5	None	Drainage Plug	0
6	02803101P	Chassis Sub-Assy	1
7	06123401	Drainage Connector	1
8	00105051	Compressor and Fittings	1
Not Shown	00180030	Compressor Overload Protector(External)	1
Not Shown	00183051	Compressor Overload Protector(External)	1
Not Shown	00183032	Compressor Overload Protector(External)	1
9	7651873209	Compressor Crankcase Heater	1
Not Shown	81028009	Capillary Sub-Assy	1
10	4300040029	4-Way Valve Solenoid Coil	1
11	03123895	4-Way Valve Assy	1
Not Shown	4300008201	4-Way Valve	1
12	0130504402P	Right Side Plate	1
13	0171501201P	Valve Support Sub-Assy	1
Not Shown	07130239	1/4-in Liquid Line Valve	1
14	07133157	5/8-in Gas/Suction Valve	1
15	02115005	Big Handle	1
Not Shown	07138807	Electronic Expansion Valve	1
16	4300876703	Electronic Expansion Valve Solenoid Coil	1
17	3900031001	Temperature Sensor Assy **	1
18	01475013	Rear Grille	1
19	01163509	Condenser Coil Assy	1
20	0180287601	Motor Support Sub-Assy	1
21	01255007	Top Cover Sub-Assy	1
23	76614102	Pass Wire Ring Sub-Assy	2
25	01305043P	Left Side Plate	1
26	15702802	Fan Motor	1
27	10000100310	Electric Control Box Assy	1
Not Shown	46020006	High Pressure Switch	1
Not Shown	30148338	Main Control Board	1

** Temperature Sensor Assembly contains Discharge, Condenser Coil and Ambient sensors.

VIR36HP230V1BH

36,000 BTUH 208/230v Indoor Unit

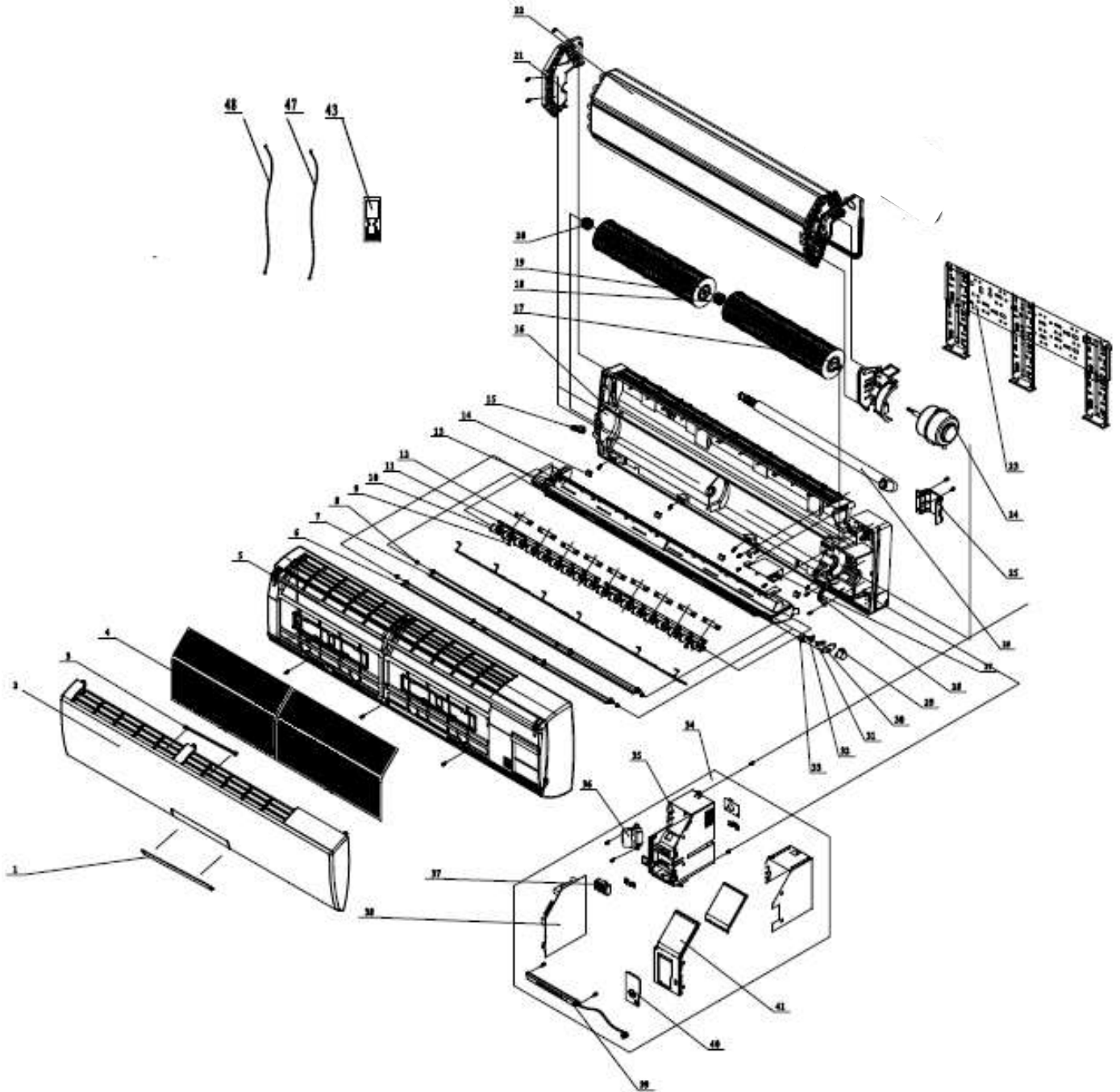

VIR36HP230V1BH
36,000 BTUH 208/230v Indoor Unit
Product Code: GWH36LB-D3DNB2G/I

NO.	Part Code	Part Description	Qty
1	22430024	Receiver Window	1
2	20000300022S	Front Panel	1
3	2421212001	Kick Stand Bar	1
4	11122106	Air Filter	2
5	20900700005	Front Case Sub-Assy	1
6	1051216601	Upper Guide Louver	1
7	1051216701	Lower Guide Louver	1
8	10542704	Axial Bushing	6
9	1051216902	Air Louver 2	2
10	1051216802	Air Louver 1	16
11	10582086	Connecting Rod	2
12	26112158	Louver Clamp	9
13	2018213802	Condensate Water Tray	1
14	2425200506	Screw Cover	4
15	76712012	Condensate Drain Plug	1
16	00000100113	Rear Case Assy	1
17	10352039	Cross Flow Fan 1	1
18	26152028	Bearing Holder Sub-Assy	1
19	10352040	Cross Flow Fan 2	1
20	76512051	Bearing Ring O-Gasket Sub-Assy	1
21	24212041	Left Evaporator Support	1
22	01002000027	Evaporator Coil Assy	1
23	01252398	Wall Mounting Bracket	1
24	1501213401	Fan Motor	1
25	26112071	Condensate Pipe Clamp	1
26	0523001404	Drainage Hose	1
27	2012212402	Cover Plate	1
28	26112324	Motor Fixed Clip 1	1
29	1521210701	Stepper Motor	1
30	26112070	Press Plate(Crank)	1
31	10582041	Crank-Guide	1
32	10562004	Upper Crank	1
33	10562005	Lower Crank	1
34	10000204114	Electric Control Box Assy	1
35	201022502	Electric Control Box	1
37	42011233	Terminal Board	1
38	30138001017	Main Control Board	1
40	201022523	Electric Box Cover	1
41	2011204404S	Electric Box Cover	1
42	30565277	Display Board	1
43	30510475	Remote Controller (YAN1F1F)	1
Not Shown	26150009	Remote Controller Holder/Cradle	1
47	390000592	Indoor Coil Temperature Sensor	1
48	390000453	Ambient Temperature Sensor	1

VIR36HP230V1BO

36,000 BTUH 208/230v Outdoor Unit

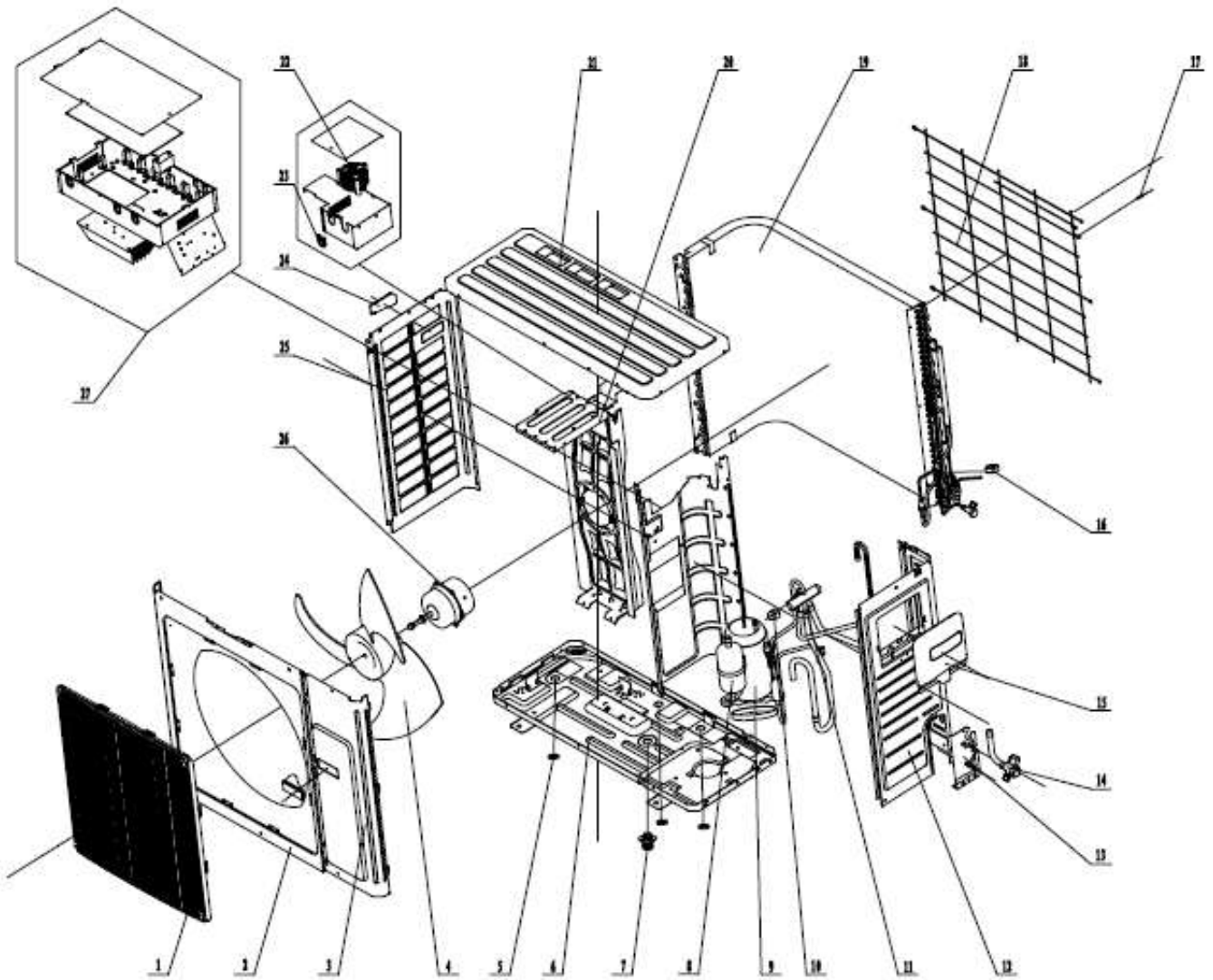

VIR36HP230V1BO
36,000 BTUH 208/230v Outdoor Unit
Product Code: GWH36LB-D3DNA3G/O

NO.	Part Code	Part Description	Qty
1	01473050	Front Grille	1
2	0153501405	Front Panel Assy	1
3	01303249P	Front Side Plate Sub-Assy	1
Not Shown	7651000413	Basepan Heater	1
4	10335014	Axial Flow Fan	1
5	None	Drainage Plug	0
6	02803026P	Chassis Sub-Assy	1
7	06123401	Drainage Connector	1
8	0020527500003	Compressor	1
Not Shown	00185012	Compressor Overload Protector(External)	1
9	7651873209	Compressor Crankcase Heater	1
10	4300040029	4-Way Valve Solenoid Coil	1
11	03123890	4-Way Valve Assy	1
Not Shown	43000338	4-Way Valve	1
12	0130504402P	Right Side Plate	1
13	0171501201P	Valve Support Sub-Assy	1
Not Shown	07130239	1/4-in Liquid Line Valve	1
14	07133157	1/2-in Gas/Suction Valve	1
15	02115005	Big Handle	1
Not Shown	07138807	Electronic Expansion Valve Assy	1
16	4300876703	Electronic Expansion Valve Solenoid Coil	1
17	3900031001	Temperature Sensor Assy **	1
18	01475013	Rear Grille	1
19	01163491	Condenser Coil Assy	1
20	01802876	Motor Support Sub-Assy	1
21	01255007	Top Cover Sub-Assy	1
23	76614102	Pass Wire Ring Sub-Assy	2
25	01305043P	Left Side Plate	1
26	1570280205	Fan Motor	1
27	10000100328	Electric Control Box Assy	1
Not Shown	46020006	High Pressure Switch	1
Not Shown	30138000711	Main Control Board	1

** Temperature Sensor Assembly contains Discharge, Condenser Coil and Ambient sensors.

